

Peggy
Sage
PARIS

PROFESSIONAL





Les produits de la marque Peggy Sage contiennent des modes d'emploi et des précautions d'utilisation, à lire attentivement et à respecter scrupuleusement pour une utilisation en toute sécurité.

Peggy Sage brand products come with instructions for use and precautions of use which should be read and followed extremely carefully to ensure safe use.



**POUR CONNAÎTRE LE DISTRIBUTEUR
LE PLUS PROCHE DE CHEZ VOUS**

**FOR DETAILS
OF YOUR NEAREST DISTRIBUTOR**

PEGGYSAGE.COM

USINE ET SIÈGE SOCIAL
PEGGY SAGE SAS FACTORY AND HEAD OFFICE
ZAC des Bordets - 295, rue des Hérons Cendrés
74130 Bonneville - France

Cover Look

131066 - crayon lèvres / lip pencil waterproof, **800510** - blush,
851005 - ombre à paupières liquide / liquid eye shadow Metallic Glow,
130361 - eyeliner pinceau / brush eyeliner, **130650** - mascara Lovely cils,
850776 - ombre à paupières / eye shadow Lumière

SOMMAIRE / CONTENTS

ONGLES / NAILS

004 - 163

VERNIS SEMI-PERMANENT 1-LAK 1-LAK SEMI-PERMANENT NAIL LACQUER	006	RÉSINE SCULPTING + COULEUR ACRYLIC SCULPTING + COLOUR	048
VERNIS SEMI-PERMANENT I-LAK I-LAK SEMI-PERMANENT NAIL LACQUER	010	VERNIS À ONGLES / NAIL LACQUER	052
I-GEL	018	MINI VERNIS À ONGLES MINI NAIL LACQUER	060
TECHNIGEL	022	VERNIS À ONGLES FOREVER LAK NAIL LACQUER FOREVER LAK	074
GEL PRO 3.1	028	SOIN DES ONGLES / NAIL CARE	078
TECHNIGEL COLOR IT	030	NAIL ART	090
GEL SCULPT	038	FORMES ET CAPSULES FORMS & TIPS	108
RÉSINE / ACRYLIC SCULPTING + RÉSINE / ACRYLIC DIP IN	042 046	ACCESSOIRES / ACCESSORIES	120

MAQUILLAGE / MAKE-UP

164 - 253

TEINT / COMPLEXION	167	LÈVRES / LIPS	212
SOURCILS / EYEBROWS	186	ACCESSOIRES / ACCESSORIES	222
YEUX / EYES	190	EMBELLISSEMENT DU REGARD GAZE ENHANCEMENT	242

ÉPILATION / HAIR REMOVAL

254 - 267

CIRE CHAUDE / HOT WAX	256	CIRE FROIDE / COLD WAX	261
CIRE TIÈDE / WARM WAX	258	PRODUITS COMPLÉMENTAIRES COMPLEMENTARY PRODUCTS	261

SOIN / CARE

268 - 365

SOIN DES MAINS / HAND CARE	270	SOIN DU CORPS / BODY CARE	334
SOIN DES PIEDS / FOOT CARE	280	SOIN POUR HOMME / MEN'S SKINCARE	362
SOIN DU VISAGE / FACE CARE	292		

ACCESSOIRES PRO / PROFESSIONAL ACCESSORIES

366 - 397

MATÉRIEL D'INSTITUT SALON EQUIPMENT	368	MATÉRIEL MARKETING MARKETING EQUIPMENT	391
MOBILIER D'INSTITUT SALON FURNITURE	385	PRÉSENTOIRS / DISPLAYS	394
BAGAGERIE / LUGGAGE	388	PRÉSENTOIRS MODULABLES MODULAR DISPLAYS	396

INDEX

400 - 404

1925



Peggy Sage, expert des ongles depuis 1925

En 1925, Peggy Sage lance son premier vernis à ongles, « le rouge » aux États-Unis. Au fil des années, la marque développe de nouvelles teintes et nouveaux flacons pour accompagner les femmes qui concilient féminité et vie active. Pour diversifier son offre vers de nouveaux métiers, la marque élargie son cœur de métier, la manucure. Revenons sur l'histoire du vernis de 1925 à nos jours.

Peggy Sage, the nails expert since 1925

In 1925, Peggy Sage launched its first nail lacquer in the United States: Le Rouge. Over the years the brand has developed new colours and new bottles for women who like to combine femininity with an active lifestyle. To diversify its offer into new markets, the brand broadened its core business of manicure products. Here, we look back at the history of nail lacquer from 1925 to the present day.

Le flacon Peggy Sage comme signature

En 1995, Peggy Sage décide d'apporter une touche personnelle sur le flacon de vernis à ongles pour apporter du renouveau et de la modernité.

The Peggy Sage bottle - its signature

In 1995, Peggy Sage decided to add a personal touch to its nail lacquer bottle to breathe new life into the product and modernise its look.

2013



LE VERNIS SEMI-PERMANENT I-LAK UN RÉSULTAT PROFESSIONNEL POUR UNE TENUE LONGUE DURÉE

C'est en 2013 qu'est créé le premier vernis semi-permanent Peggy Sage. L'indémoudable I-LAK s'utilise avec une base, un top coat et une lampe UV. Les premiers vernis se lancent en format 15 ml et se déclinent en 60 couleurs détonantes pour offrir une manucure parfaite et longue durée. Fort de son succès, Peggy Sage développe une gamme en format 9 ml, les I-LAK MINI, afin de répondre à tous les besoins.

I-LAK SEMI-PERMANENT NAIL LACQUER PROFESSIONAL RESULTS FOR A LONG-LASTING HOLDT

It was in 2013 that Peggy Sage created its first semi-permanent nail lacquer. The timeless I-LAK was developed for use with a base, a top coat and a UV lamp. The first lacquers were launched in a 15ml bottle and a range of 60 explosive colours for the perfect long-hold manicure. Spurred on by its success, Peggy Sage developed a range in a 9ml size – the I-LAK MINIS - to broaden their appeal.

2014



LE VERNIS À ONGLES FORMAT MINI À EMPORTER PARTOUT

Peggy Sage n'en oublie pas les vernis à ongles classiques ! Le vernis à ongles 5 ml fait son entrée sur le marché en 2014. Des petits flacons à emporter partout pour des manucures hautes en couleurs !

THE GO-ANYWHERE MINI-SIZE NAIL LACQUER

But Peggy Sage didn't forget about conventional nail lacquers, marketing the 5ml nail lacquer size for the first time in 2014. A range of go-anywhere mini-bottles for manicure big in colour!

AUJOURD'HUI / AND TODAY?

Pour marquer son histoire sur le vernis, Peggy Sage s'inspire de ses vernis à ongles classiques pour renouveler ses packagings sur les gammes de vernis semi-permanents I-LAK et 1-LAK en uniformisant les flacons.

In a nod to its long history of creating nail lacquers, Peggy Sage has taken inspiration from its classic nail lacquers to design new packaging for its I-LAK and 1-LAK semi permanent nail lacquers, introducing a single bottle design.



2016

FOREVER LAK LE VERNIS À ONGLES LONGUE TENUE, FORMULE HYBRIDE

Pour aller encore plus loin, Peggy Sage développe en 2016 une nouvelle gamme de vernis à ongles longue tenue avec séchage à l'air libre. Les Forever LAK s'utilisent sans lampe, avec une base et un top coat. Leur formule hybride garantit un résultat longue tenue.

FOREVER LAK - THE HYBRID-FORMULA LONG-HOLD NAIL LACQUER

Going even further, in 2016 Peggy Sage developed a new range of naturally drying long-hold nail lacquers. The Forever Lak range doesn't require a lamp and is used with a base and top coat. Its hybrid formula guarantees long-lasting results.



2017

LE VERNIS SEMI-PERMANENT 1-LAK, LA MANUCURE EXPRESS 3 EN 1

Toujours soucieuse des nouvelles tendances et des dernières innovations, Peggy Sage développe la gamme 1-LAK en 2017. Révolutionnaire, le vernis semi-permanent 3 en 1 ne nécessite ni base, ni top coat et permet d'obtenir une manucure longue tenue en un temps record.

1-LAK SEMI-PERMANENT NAIL LACQUER, THE 3-IN-1 EXPRESS MANICURE

Always up there with the new trends and latest innovations, Peggy Sage developed the 1-LAK range in 2017. This revolutionary 3-in-1 semi-permanent nail lacquer needs no base or top coat, creating a long-hold manicure in record time.



“ **SOIGNEZ ET EMBELLISSEZ LES ONGLES AVEC NOTRE GAMME COMPLÈTE SPÉCIALE MANUCURIE !** ”

Depuis plus de 90 ans, Peggy Sage vous propose son expertise dans les domaines de la manucurie et de la prothèse ongulaire. Le vernis classique et vernis semi-permanent, idoles de la marque accompagnent la pratique des professionnels dans leur activité quotidienne. Nous vous proposons de développer vos prestations et vos ventes à travers des gammes à la pointe de la technologie. Vos créations n’auront pas de limite grâce à nos gammes de vernis, gel UV, résine !

“ **LOOK AFTER AND BEAUTIFY YOUR CLIENTS’ NAILS WITH OUR COMPLETE MANICURE RANGE.** ”

Peggy Sage has been providing its manicure and artificial nail construction expertise for more than 90 years. Our iconic classic and semi-permanent nail lacquers are for use by professionals in their day-to-day work. Develop your services and sales with our different product ranges at the cutting edge of technology. With our ranges of lacquers, UV gels and acrylic resins, your creativity knows no bounds!

VERNIS SEMI-PERMANENT 1-LAK 1-LAK SEMI-PERMANENT NAIL LACQUER	006	SCULPTING + COULEUR / COLOUR VERNIS À ONGLES / NAIL LACQUER	048 052
VERNIS SEMI-PERMANENT I-LAK I-LAK SEMI-PERMANENT NAIL LACQUER	010	MINI VERNIS À ONGLES MINI NAIL LACQUER	056
I-GEL	018	VERNIS À ONGLES FOREVER LAK NAIL LACQUER FOREVER LAK	064
TECHNIGEL	022	SOIN DES ONGLES / NAIL CARE	078
GEL PRO 3.1	028	NAIL ART	090
TECHNIGEL COLOR IT	030	FORMES ET CAPSULES	108
GEL SCULPT	038	FORMS & TIPS	120
SCULPTING +	042		
DIP IN	046	ACCESSOIRES / ACCESSORIES	120



O N G L E S / N A I L S

1 - L A K

1-LAK, le vernis semi-permanent pour une manucure express !

L'innovation 1-Lak associe la base, la couleur et la finition dans un seul flacon.

Ce vernis semi-permanent 3-en-1 est idéal pour les personnes pressées. Texture ultra-couvrante et longue tenue !

1-LAK, the semi-permanent nail lacquer for an express manicure!

Our innovative 1-LAK combines a base, colour and finish in one bottle. This 3-in-1 semi-permanent nail lacquer is ideal for when you're in a hurry. Ultra-covering texture with a long hold.



1-LAK - 3 IN 1 GEL POLISH

Vernis semi-permanent 3-en-1 pour une manucure parfaite en un temps record. Les 1-LAK Peggy Sage s'appliquent en 2 couches fines pour une manucure haute en couleur et une tenue longue durée. Pas besoin de base et de top finish : un seul produit suffit pour sublimer vos ongles !

3-in-1 semi-permanent nail lacquers for the perfect manicure in record time. Apply 2 thin coats of these Peggy Sage 1-LAK lacquers for a colourful manicure with a long hold. No need for base or top finish – one product is all you need for beautiful nails!

5 ml - polymérisation / polymerization 30 s LED = 2 min UV



LAQUÉS LACQUER PRODUCTS



182000
angel white



182001
frenchie rose



182043
cosy sand



182044
wild rose



182002
sweet fantasy



182009
little dreamer



182069
pink lemonade



182050
punky rose



182070
lavender crush



182006
pink starlet



182007
morning crush



182008
neon passion



182012
fairy queen



182079
evening dress



182011
fuchsia mania



182004
mango-go-go



182005
neon love



182010
flower bloom



182039
blind date



182078
cocktail party



182038
artie selfie



182051
fashionista



182068
flamingo island



182003
mellow melon



182067
vitamin crush



182077
dance on the beach



182066
funny poppy



182013
hot spot



182014
femme fatale



182015
pomme d'amour



182016
millenium red



182063
love tribute



182076
romantic dinner



182055
Romeo in love



182018
dating diva



182040
pretty busy



182041
on-the-go



182017
gala dress



182065
falling night



182029
black velours

LAQUÉS LACQUER PRODUCTS



1-LAK - 3 IN 1 GEL POLISH

5 ml - polymérisation / polymerization 30 s LED = 2 min UV



182071
mint candy



182075
secret garden



182080
jump in the water



182052
eden green



182053
overseas blue



182081
cruising boat



182059
Juliette



182048
graphic violine



182058
dancing in the rain



182037
jetlag



182057
city walk



182028
sandy dune



182042
sweet almond



182046
pretty pearl



182047
latte break



182036
ladylike

NACRÉS PEARL PRODUCTS



182072
pearly sweet



182062
Christmas kiss



182054
haute couture

PAILLETÉS / GLITTER PRODUCTS



182074
fresh lavender



182056
romantic grey



182049
bikini baby



182064
dreamy party

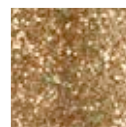

182034
feel the magic



182060
golden night



182901

XTRA GLOSS & SHINE TOP COAT

Pour les adaptes de l'ultra-brillance, ajoutez une couche de top coat xtra gloss & shine à votre pose 1-LAK, catalysez. Sans résidu collant.

If you're after the ultimate gloss finish, add a coat of Xtra gloss & shine top coat to your 1-LAK application and catalyze. Does not leave a sticky residue.

182901 - 5 ml

polymérisation / polymerization 60 s LED = 2 min UV



O N G L E S / N A I L S

I - L A K

I-LAK, le vernis semi-permanent pour une manucure professionnelle longue tenue !

La gamme de vernis semi-permanent I-Lak vous offre un large choix de couleurs et de nombreux produits complémentaires pour réaliser une manucure professionnelle parfaite ! Facile d'application pour un résultat brillant longue tenue !

I-LAK, the semi-permanent nail lacquer for a professional long-hold manicure!

Our innovative 1-LAK combines a base, colour and finish in one bottle. This 3-in-1 semi-permanent nail lacquer is ideal for when you're in a hurry. Ultra-covering texture with a long hold.

I-LAK

Semi permanent nail colours

NEW

PRIMER I-LAK

Idéal pour les ongles présentant une mauvaise adhérence : dégraisser la surface de l'ongle avec le cleaner triple action 146017, puis appliquer le primer I-LAK sans toucher les cuticules ni le contour de l'ongle. Réaliser ensuite votre pose d'I-LAK selon la méthode Peggy Sage.

Ideal for nails with poor adherence: degrease the nail surface with triple-action cleaner 146017 and then apply I-LAK primer, being careful not to touch the cuticles or the area around the nail. Then apply your I-LAK using the Peggy Sage method.

191850 - 11 ml



BASE UV I-LAK

S'applique en couche fine pour une adhérence parfaite des vernis semi-permanents I-LAK tout en protégeant l'ongle naturel.

I-LAK UV BASE COAT

Apply a thin coat to ensure a perfect hold for the I-LAK semi-permanent nail lacquers while protecting the natural nail.

191000 - 11 ml

polymérisation / polymerization 10 s LED = 1 min UV

CARE BASE UV - FORTIFIANTE

Soin fortifiant pour les ongles dévitalisés, mous, cassants et endommagés, grâce à sa formule enrichie en vitamines A, B5 et E. La base care s'applique en couche fine, seule ou avec le top finish I-LAK pour un fini ultra brillant. Idéale après une dépose, ou en cure toutes les 2, 3 applications d'I-LAK afin de renforcer et protéger l'ongle naturel.

CARE BASE UV I-LAK SOAK OFF GEL POLISH

Fortifying treatment for tired, soft, fragile and damaged nails containing a formula with vitamins A, B5 and E. Apply a thin coat of care base on its own, or with I-LAK top finish for an ultra-glossy finish. Perfect for application after an artificial nail removal or as a treatment after every 2 to 3 I-LAK applications to strengthen and protect the natural nail.

191880 - 11 ml

polymérisation / polymerization 30 s LED = 2 min UV



NEW



BASE PEEL-OFF I-LAK

S'applique à la place de la base I-LAK 191000 lors d'une pose d'I-LAK. Se retire délicatement en pellicule, pour une dépose rapide et sans acétone.

I-LAK PEEL-OFF BASE

Apply instead of I-LAK base 191000 before your I-LAK application. Forms a film that peels off gently for quick removal with no acetone needed.

191860 - 11 ml - polymérisation / polymerization 30 s LED = 2 min UV

BASE PEEL-OFF I-LAK / 20 PATCHS ADHÉSIFS

Repousser les cuticules, limez et dépolissez légèrement la surface des ongles. Appliquer-le sur le haut de l'ongle puis lissez-le ensuite de chaque côté de l'ongle sans faire de pli ni de bulle. Réaliser ensuite votre pose de couleur I-LAK (il n'y a plus besoin de base). Lors du retrait, décollez tout simplement le patch.

I-LAK PEEL-OFF BASE / 20 ADHESIVE PATCHES

Instructions for use: prepare your nails using the Peggy Sage method: push back the cuticles, file and lightly roughen the nail surface. Choose a patch the same size as your nail. Apply it to the base of the nail then smooth it onto each side of the nail without creating folds or trapping air bubbles. Next, apply your chosen I-LAK colour (you do not need a base). When removing, simply peel off the patch.

199999 - 10 tailles / 10 sizes



NEW



191176
clear

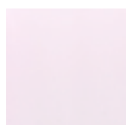

191177
baby pink



191178
cover pink



191179
cover peach

I-LAK BUILDER BASE

La combinaison innovante d'une base et d'une construction vernis semi-permanent en flacon. S'applique en couche fine avant la pose de couleur. Permet de renforcer votre pose.

An innovative combination of a base and semi-permanent builder lacquer in a bottle. Apply a thin coat before adding your colour. Strengthens your application.

11 ml - polymérisation / polymerization 30 s LED = 2 min UV

VERNIS SEMI-PERMANENT I-LAK
 Vernis semi-permanent professionnel pour une manucure parfaite et longue durée. Appliquer la couleur en 2 couches fines, pour une couleur intensive et un résultat sans défauts. Pose ultra facile tel un vernis.
 Vernis semi-permanents I-LAK compatibles UV/LED.

I-LAK SEMI-PERMANENT NAIL LACQUER
 Professional semi-permanent nail lacquers for a perfect, long-lasting manicure. Apply 2 thin coats of colour for an intense shade and faultless results. So easy to apply, like nail lacquer. I-LAK UV/LED-compatible semi-permanent nail lacquers.

11 ml - polymérisation / polymerization 30 s LED = 2 min UV



NEW

LAQUÉS LACQUER PRODUCTS



191502
pure snow



191015
blanc pur



191507
ballerine



191102
wedding dress



191519
porcelain beige



191014
peachy nude



191604
nude dentelle



191640
perfect nude



191605
café latte



191641
wild elegance



191126
save the date



191127
take my heart



191603
toffee cream



191125
sheer bliss



191558
secret boudoir



191019
opaline



191600
kiss the bride



191602
organdi chéri



191128
best day ever



191124
hello Rosie



191130
love's in the air



191103
girl in love



191588
punky rose



191629
dream land



191630
pop balloon



191636
flamingo pop



191138
wavy bikini



191508
Valence



191137
sweet candy



191142
sea sunrise



191141
dream love



191047
sunset coral



191028
neon pink



191035
red passion



191073
Biarritz



191619
rumba latina



191107
bois de rose



191108
Cindy



191526
rosy nude



191616
boogie swing



191618
cha cha diva

LAQUÉS LACQUER PRODUCTS



VERNIS SEMI-PERMANENT I-LAK I-LAK SEMI-PERMANENT NAIL LACQUER

11 ml - polymérisation / polymerization 30 s LED = 2 min UV



191635
aloha Hawaiï



191590
cosmic mango



191046
orange sanguine



191113
pacific coral



191029
neon orange



191633
good vibes



191112
Grenade



191595
fantastic red



191523
fresh corail



191585
coral appeal



191121
red envy



191122
Moscou



191623
red carpet



191648
father christmas



191574
ruby glory



191512
terre de Sienna



191011
red salsa



191620
rock'n'red



191621
gala dress



191565
Vanessa



191522
spy beige



191650
merry burgundy



191513
lipstick red



191514
juicy cherry



191639
burgundy chérie



191017
chestnut red



191016
dark cherry



191596
retro tango



191517
tulipe noire



191516
aubergine chic



191515
elegant plum



191139
magic island



191637
hipsta mania



191631
cupcake fairy



191615
Laurie



191614
violet queen



191638
summer splash



191140
blue lagoon



191642
all cats are grey



191148
skyscraper



191617
jazzy mambo



191643
moonrise



191568
enigmatic grey



191101
aquamarine



191536
funny wasabi



191597
gipsy kaki



191644
in the woods

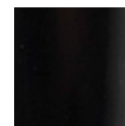

191002
nuit



VERNIS SEMI-PERMANENT I-LAK
I-LAK SEMI-PERMANENT NAIL LACQUER

11 ml - polymérisation / polymerization 30 s LED = 2 min UV



NACRÉS
PEARL PRODUCTS



191557
milky twist



191601
peachy glow



191539
orchid bride



191591
papaya mania



191511
rouge flamboyant



191622
ruby star

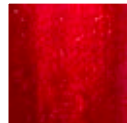

191058
red satin



191143
pearly peach



191584
spring break



191114
sunset terrace



191646
precious dream



191566
scintillant beige



191626
splendid moon



191561
Marine

NEW



VERNIS SEMI-PERMANENT I-LAK
I-LAK SEMI-PERMANENT NAIL LACQUER

11 ml - polymérisation / polymerization 30 s LED = 2 min UV

PAILLETÉS / GLITTER PRODUCTS



191609
silver mine



191132
glitzy silver



191610
diamond sky



191134
glitter fever



191549
fizzy million

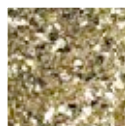

191131
glitzy gold



191548
lux goddess



191647
shiny flakes



191147
tropical oasis

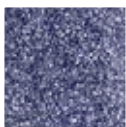

191149
galactic blue



191573
dazzling tutu



191133
glitzy rose



191520
cherry flower



191129
bride's team



191144
romantic pink



191611
Julie

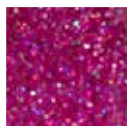

191146
rosy space



191145
shiny fuchsia



191589
freaky pink



191634
beach party



191074
wild papaya



191135
happy mango

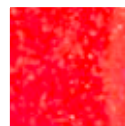

191136
celebrate pink

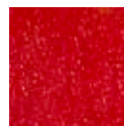

191123
audacious love



191649
red ceremony

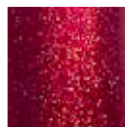

191575
VIP red



191567
charming spell



191645
holy night

TOP FINISH UV I-LAK
S'applique en couche fine pour une finition ultra-brillante.
Protège l'éclat de la couleur et prolonge la tenue des vernis semi-permanents I-LAK.

I-LAK SOAK OFF GEL POLISH TOP FINISH
Apply a thin coat for an ultra-shiny finish. Protects the colour brightness and extends the wear of the I-LAK semi-permanent nail lacquers.

191001 - 11 ml
polymérisation / polymerization 30 s LED = 2 min UV



TOP FINISH UV MAT I-LAK

S'applique en couche fine pour un fini mat, tout en prolongeant la tenue des vernis semi-permanents I-LAK, idéal en nail art.

I-LAK UV MAT TOP FINISH

Applying a thin coat for a mat finish is an ideal nail art technique and also extends the hold of I-LAK semi-permanent nail lacquers.

191800 - 11 ml
polymérisation / polymerization 30 s LED = 2 min UV



O N G L E S / N A I L S

I - G E L 2 . 0

Le gel nouvelle génération auto-égalisant pour un modelage facile et rapide !

La gamme I-GEL 2.0 garantit une construction de l'ongle aisée. Façonner rapidement le bombé de l'ongle grâce à sa texture fluide et auto-égalisante. Compatible avec les couleurs, I-LAK, 1-Lak et gels UV pour des créations à l'infini.

The new-generation self-levelling gels for easy, fast nail sculpting!

The I-GEL 2.0 range is the sure-fire way to easy nail construction. Its fluid, self-levelling texture makes shaping the nail curve really fast. Compatible with our I-LAK, 1-LAK and UV gel colours for endless nail creations.

Viscosité / Viscosity

 Gel épais / Thick gel

 Gel moyennement épais /
Moderately thick gel

 Gel fin / Thin gel

Opacité / Opacity

 Transparent / Transparent

 Médium / Medium

 Opaque / Opaque

PRIMER I-GEL 2.0
S'applique en couche très fine pour renforcer la tenue de l'I-GEL.
Apply a very thin layer to improve the hold of I-GEL products.

146560 - 11 ml



BASE COAT UV&LED I-GEL 2.0

S'applique en couche fine pour faciliter l'adhérence du gel de construction.
Apply a thin coat to improve builder gel adhesion.

Polymérisation / polymerization 30 s LED = 2 min UV

146561 - 11 ml - transparent / clear

146562 - 11 ml - rose / pink



146565



146566

GEL DE CONSTRUCTION UV&LED I-GEL 2.0

S'applique sur ongles naturels et/ou capsules. Auto-égalisant, idéal pour un modelage précis du bombé de l'ongle.

BUILDER GEL UV&LED I-GEL 2.0

Self-levelling, ideal for neat sculpting of the nail curve.

Polymérisation / polymerization 30 s LED = 2 min UV

146565 - 15 g - transparent / clear

146566 - 15 g - rose / pink



146569



146570

146569 - 50 g - transparent / clear

146570 - 50 g - rose / pink

GEL DE CAMOUFLAGE UV&LED I-GEL 2.0

Ce gel permet de rallonger la base de l'ongle et de réaliser des constructions dures. Grâce à sa couleur effet naturel, il unifie la couleur de l'ongle et camoufle les imperfections et les défauts de la plaque de l'ongle.

UV&LED I-GEL 2.0 COVER-UP GEL

This gel is for extending the base of the nail for hard nail constructions. This natural-looking colour evens up the nail colour and covers up imperfections and flaws in the nail plate.

Polymérisation / polymerization 30 s LED = 2 min UV

146567 - 15 g - pêche / peach

146568 - 15 g - rose / pink



146567



146568

FRENCH MANUCURE UV&LED I-GEL 2.0
S'applique sur le bord libre de l'ongle pour une French manucure extra blanche.

FRENCH MANICURE UV&LED I-GEL 2.0
Apply on the nail's free edge for an extra-white French manicure.

Polymérisation / polymerization 30 s LED = 2 min UV

146564 - 11 ml



TOP FINISH UV&LED I-GEL 2.0

Cette finition apporte de la brillance et de la protection à votre pose de gel.
S'applique en couche fine.

UV&LED I-GEL 2.0 TOP FINISH

This finish gives your gel application a glossy, protective sheen. Apply a thin coat.
Polymérisation / polymerization 30 s LED = 2 min UV

146563 - 11 ml



O N G L E S / N A I L S

T E C H N I G E L

Réaliser toutes les techniques de prothèse ongulaire grâce à nos multiples gels aux textures différentes. Fluide, dur médium ou dur, compléter votre construction avec nos gels de camouflage, de french manucure ou de couleurs. Cette large gamme s'adapte parfaitement à l'ongle naturel, aux capsules et aux formes pour des résultats professionnels.

Our extensive range of gels with different textures are suitable for every artificial nail construction technique.

Fluid, medium or hard, you can use our cover-up, French manicure and coloured gels to complete your nail constructions. This wide range is perfect for use on natural nails, tips and forms, for professional results.

STYLO PRIMER

S'applique avant toute pose de gel sur ongles naturels et/ou capsules pour renforcer la tenue du gel UV de base.

PRIMER PEN

Apply to natural nails and/or tips before applying gel, for improved hold of the base UV gel.

146630 - 3,2ml

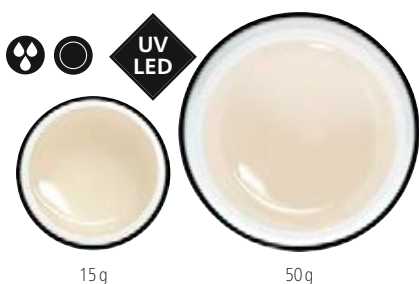

15g

50g

GEL UV & LED DE BASE

S'utilise avant le gel UV de construction pour en faciliter l'adhérence. Peut également s'utiliser pour les petits remplissages.

BASE UV & LED NAIL GEL

Use before the builder UV gel for improved builder gel adhesion. Can also be used for small infills.

Polymérisation / polymerization 30 s LED = 2 min UV

146640 - 15g

146641 - 50g

GEL UV & LED DE BASE

POUR ONGLES FRAGILISÉS / ENDOMMAGÉS

A la texture fibreuse, ce gel renforce les ongles fragilisés et comble les ongles endommagés. Flexible, assure le confort du port de la matière sur les ongles. Viscosité haute / Auto-égalisant / Opaque / Ne coule pas dans les gorges de l'ongle.

BASE UV & LED GEL FOR WEAK / DAMAGED NAILS

This gel with a fibrous texture strengthens weak nails and fills damaged nails. This flexible gel ensures that the material feels comfortable on the nail. High viscosity / Self-levelling / Opaque / Does not run into the nail fold.

146690 - 15g - polymérisation / polymerization 30 s LED = 2 min UV

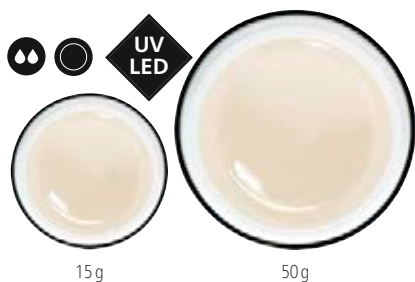
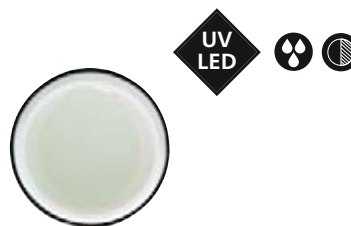

15g

50g

GEL DE BASE ULTRA BONDER UV&LED

S'utilise avant le gel de construction pour une adhérence optimale, viscosité moyenne, transparent.

ULTRA-BONDER UV&LED BASE GEL

For use before builder gel for improved builder gel adhesion. Medium viscosity, transparent.

Polymérisation / uitharden 30 s LED = 2 min UV

146691 - 15g

146692 - 50g

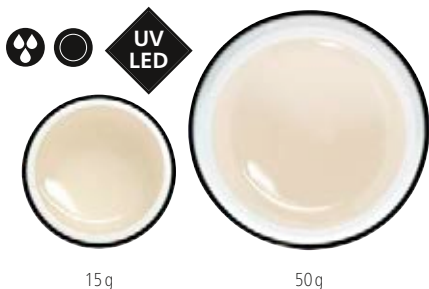

GEL UV & LED DE CONSTRUCTION FLUIDE

S'applique sur ongles naturels et/ou capsules.
Viscosité moyenne / auto-égalisant.
Ne coule pas dans les gorges de l'ongle / idéal pour le remplissage.

FLUID BUILDER UV & LED GEL

Apply to natural nails and/or tips. Medium viscosity / Self-levelling / Opaque / Does not run into the nail fold / Ideal for infilling.

Polymérisation / polymerization 30 s LED = 2 min UV

146642 - 15g

146643 - 50g

GEL UV DE CONSTRUCTION DUR MEDIUM

Gel technique pour un modelage et une mise en forme précise du bombé. S'applique sur capsules. Viscosité moyenne / texture souple pendant l'application qui se durcit une fois le travail au pinceau fini / se lime facilement pour faciliter la mise en forme.

HARD BUILDER UV GEL MEDIUM

Technical gel for neat sculpting and shaping of the nail curve. For application on tips. Medium viscosity / Fluid texture during application that hardens once brush application is complete / Can easily be filed for easy shaping.

Polymérisation / polymerization 2 min UV

146644 - 15g

146645 - 50g



146657

15g - transparent

146653

15g - rose

146654

50g - rose

NEW

146658

15g - French

146673

15g - pêche

146674

50g - pêche

GEL UV DE CONSTRUCTION DUR

Viscosité moyenn / auto-égalisant / très facile d'application.
Ne coule pas dans les gorges de l'ongle / très bonnes adhérence et brillance.

HARD UV BUILDER GEL

Medium viscosity / Self-levelling / Very easy to apply / Does not run into the nail fold / Very good adhesion and high shine.

Polymérisation / polymerization 2 min UV

146657 - 15g - transparent

146653 - 15g - rose

146654 - 50g - rose

Polymérisation / polymerization 30 s LED = 2 min UV

146658 - 15g - French

146673 - 15g - pêche

146674 - 50g - pêche

GEL UV UNIVERSEL NATUREL 1 PHASE

S'utilise pour tout type de pose. Facile et rapide, une seule couche suffit. Viscosité moyenne / auto-égalisant / très facile d'application / très bonnes adhérence et brillance.

UNIVERSAL NATURAL 1-PHASE UV GEL

Suitable for all types of applications. Easy and fast, one coat is sufficient. Medium viscosity / Self-levelling / Very easy to apply / Very good adhesion and high shine.

Polymérisation / polymerization 2 min UV

146670 - 15g

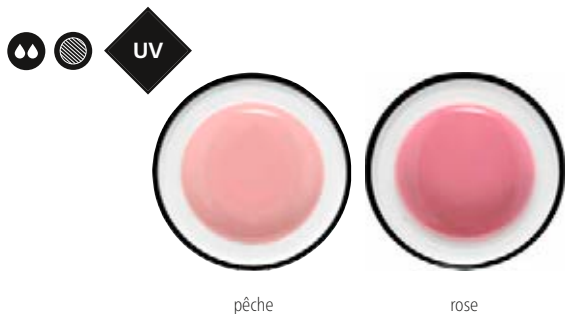
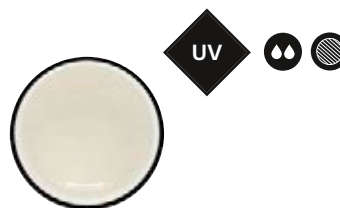

GEL UV DUR CAMOUFLAGE

Imitant la couleur naturelle de l'ongle, ce gel permet de corriger toutes les irrégularités/défauts de la surface de l'ongle et de rallonger la base de l'ongle. 2 teintes pour s'adapter aux différentes carnations de peau.

COVER-UP HARD BUILDER GEL

This builder gel imitates the natural nail colour, correcting all the irregularities/flaws in the nail surface and extending the base of the nail. 2 colours matching different skin complexions.

Polymérisation / polymerization 2 min UV

146655 - 15g - pêche

146656 - 15g - rose

GEL UV ADHÉSION RENFORCÉE

S'applique sur ongles naturels et/ou capsules pour les ongles qui ne fixent pas le gel UV. Gel monophasé / viscosité haute / auto-égalisant / très facile d'application / ne coule pas dans les gorges de l'ongle / très bonnes adhérence et brillance.

STRONG-HOLD BUILDER UV GEL

Apply to natural nails and/or tips where UV gel does not adhere properly to the nail. One-phase gel / High viscosity / Self-levelling / Very easy to apply / Does not run into the nail fold / Very good adhesion and high shine.

Polymérisation / polymerization 2 min UV

146646 - 15g

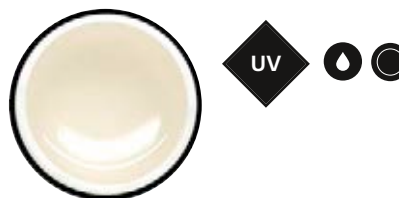

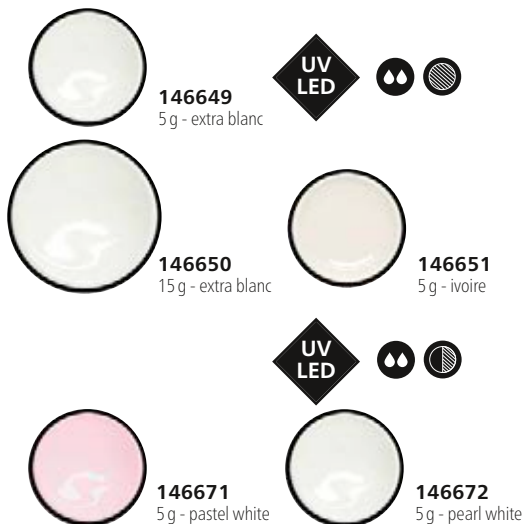

GEL UV & LED FRENCH MANUCURE

Pour une French manicure extra-blanche ou naturelle.

FRENCH MANICURE UV & LED GEL

For an extra-white or natural French manicure.

Polymérisation / polymerization 30 s LED = 2 min UV

146649 - 5 g - extra blanc
couvrance intense / intense coverage

146650 - 15 g - extra blanc
couvrance intense / intense coverage

146651 - 5 g - ivoire
couvrance intense / intense coverage

146671 - 5 g - pastel white
couvrance intense / intense coverage

146672 - 5 g - pearl white
couvrance intense / intense coverage

GEL UV DE FINITION GLOSS

S'applique en finition pour une brillance extrême. Viscosité moyenne.

GLOSS FINISHING UV GEL

Apply as a finishing coat for an ultra-shiny look. Medium viscosity.

Polymérisation / polymerization 2 min UV

146660 - 15 g - transparent **146661** - 50 g - transparent

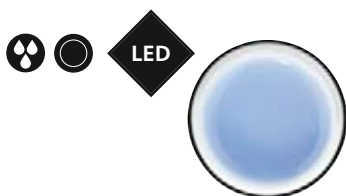

GEL LED DE FINITION GLOSS

S'applique en finition pour une brillance extrême. Viscosité moyenne.

GLOSS FINISHING LED GEL

Apply as a finishing coat for an ultra-shiny look. Medium viscosity.

Polymérisation / polymerization 30 s LED

146664 - 15 g - transparent

GEL UV DE FINITION MAT

Pour transformer toutes vos poses classiques et obtenir une finition mate sobre et chic.

MATT FINISHING GEL

For transforming all your standard applications and for a simple, smart matt finish.

Polymérisation / polymerization 2 min UV

146659 - 15 g - transparent



HIGH GLOSS TOP GEL UV&LED

Gel de finition ultra-brillant.

UV&LED HIGH GLOSS TOP GEL

Ultra glanzende finish gel.

polymérisation / polymerization 60 s LED = 2 min UV

146682 - 15 ml



FLEXI'GLOSS - GEL DE FINITION FLEXIBLE ULTRA BRILLANT

Une formule souple et élastique qui permet de ne pas craqueler lors de la repousse de l'ongle naturel. Protège votre pose, sans se fissurer. S'utilise sur toutes les surfaces et s'adapte à toutes les techniques de prothèse ongulaire. Sans résidu collant. Ne se dégraisse pas. Viscosité moyenne.

S'applique en couche fine.

FLEXI'GLOSS - ULTRA-GLOSSY FLEXIBLE FINISHING GEL

A supple elastic formula that prevents cracking when the natural nail grows. Protect your application and keep it crack-free. Can be used on all surfaces and with any artificial nail construction technique. Does not leave a sticky residue.

Does not require degreasing. Medium viscosity. Apply a thin coat.

Polymérisation / polymerization 30 s LED = 2 min UV

146684 - 11 ml



GLOSSY SEALER UV&LED

Gel de finition transparent ultra brillant : appliquer en couche fine grâce à son pinceau intégré, polymériser, il ne laisse aucun résidu collant et ne se dégraisse pas.

UV&LED GLOSS NAIL SEALER

Ultra-glossy transparent finishing gel: apply a thin coat using the integrated brush and polymerize. This sealer leaves no sticky residue and does not need degreasing.

146685 - 15 ml - polymérisation / polymerization 30 s LED = 2 min UV

MY STARTER KIT TECHNIGEL

Envie de découvrir la gamme Technigel Peggy Sage ? My starter Kit Technigel contient 4 indispensables pour réaliser des poses de gel parfaites : un gel UV & LED de base, un gel UV de construction dur médium, un gel UV & LED French extra-blanc et un gel UV de finition gloss, en petits formats et joliment disposés dans un coffret d'essai !

MY TECHNIGEL STARTER KIT

Keen to discover the Peggy Sage Technigel range? My Technigel starter kit contains 4 essentials for perfect gel nails: a UV&LED base gel, a medium-hard builder UV gel, an extra white French manicure UV&LED gel and a gloss UV finishing gel, presented in small bottles attractively arranged in a starter box set!

746690 - 4x5g





O N G L E S / N A I L S

G E L P R O 3 . 1

Le gel monophasé expert : un seul produit pour une pose complète d'extension.

Cette gamme vous offre des gels 3-en-1 : base, construction et finition. Nos gels conviennent parfaitement aux professionnels débutants. Une manucure en un temps record pour une longue tenue.

The one-phase gel for experts: just one product for a complete nail extension application.

This range consists of 3-in-1 gels: base, builder and finish. Our gels are perfectly suitable for inexperienced professionals. A long-hold manicure in record time.



GEL PRO 3.1

Gel monophasé nécessitant peu de limage / gain de temps / auto-égalisant / finition brillante. Travail possible sur ongles naturels, capsules et extensions sur formes.

One-phase gel that requires little filing / time-saving / self-levelling / glossy finish. Can be used on natural nails, tips and extensions on forms.

146620 - 15 g - transparent - polymérisation / polymerization 2 min UV

146621 - 15 g - rose - polymérisation / polymerization 2 min UV

146635 - 15 g - transparent rosé - polymérisation / polymerization 2 min UV

146636 - 15 g - transparent rosé - polymérisation / polymerization 30 s LED = 2 min UV

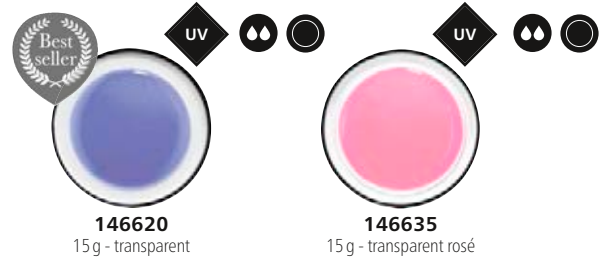

146620
15 g - transparent

146635
15 g - transparent rosé

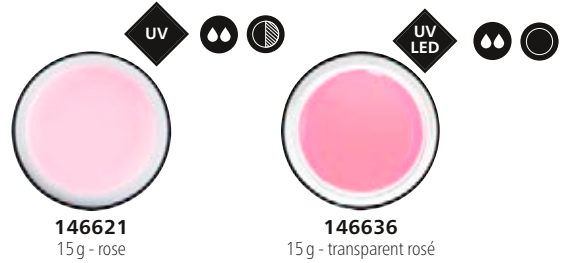

146621
15 g - rose

146636
15 g - transparent rosé

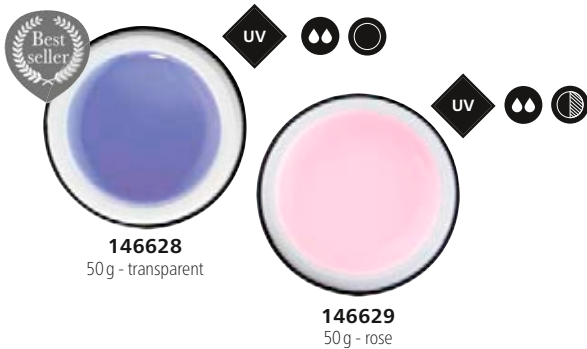

146628
50 g - transparent

146629
50 g - rose

146628 - 50 g - transparent - polymérisation / polymerization 2 min UV

146629 - 50 g - rose - polymérisation / polymerization 2 min UV

146622 - 15 g - camouflage naturel beige - polymérisation / polymerization 2 min UV

146623 - 15 g - camouflage naturel pink - polymérisation / polymerization 2 min UV

146624 - 15 g - camouflage pink - polymérisation / polymerization 2 min UV

146625 - 15 g - French manucure blanc - polymérisation / polymerization 30 s LED = 2 min UV

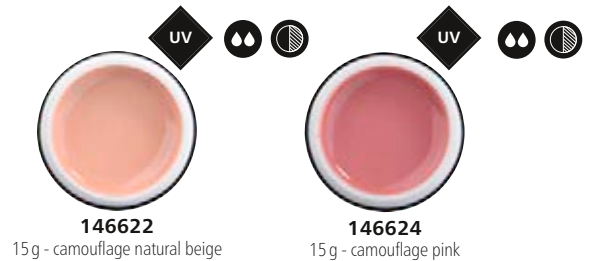

146622
15 g - camouflage naturel beige

146624
15 g - camouflage pink



146623
15 g - camouflage naturel pink

146625
15 g - French manucure blanc



146626
15 ml - transparent

146627
15 ml - transparent rosé

TOP GEL PRO 3.1

Pour les inconditionnel(le)s de l'ultra brillance, compléter votre pose de gel PRO 3.1 par l'application d'un top gel.

Convient également en finition des autres gels de notre gamme.

For those who demand an ultra-glossy finish, follow up your application of PRO 3.1 gel with an application of top gel. Can also be used as a finish with the other gels in our range.

Polymérisation / polymerization 30 s LED = 2 min UV

146626 - 15 ml - transparent

146627 - 15 ml - transparent rosé



O N G L E S / N A I L S

T E C H N I G E L C O L O R I T

Le gel durable et éclatant parfait pour des manucures ultra colorées.

Les couleurs de gel UV Color It s'appliquent une fois la construction en gel réalisée, mais aussi sur capsules ou résine pour apporter durablement dynamisme et éclat à votre manucure !

This stunning, durable gel is perfect for incredibly colourful manicures.

Color It UV gel colours are applied once gel construction is complete, but they can also be applied to tips and acrylic resin, for a long-lasting, stunning and lively manicure!

technigel color it!

GEL DE COULEUR UV & LED COLOR IT COLOR IT COLOURED UV & LED NAIL GEL

5 g - polymérisation / polymerization 30 s LED = 2 min UV



LAQUÉS LACQUER PRODUCTS



146471
classy white



146884
crocus



146883
eau de rose



146920
silky nude



146782
silky peach



146428
nougat délicat



146915
nude beige



146791
pinky beige



146493
you & me



146850
French rose



146446
angelic pink



146475
morning glow



146423
rose bonbon



146492
maid of honor



146794
rétro pink



146497
cloudy storm

NEW



146419
love industry



146498
pretty flower



146426
sugar addict



146901
pink fabuleux



146480
dance floor



146828
flamingo rose



146458
single lady



146476
boho flamingo

NEW

NEW



146447
girly cupcake



146927
Venice



146827
pink guimauve



146885
tornado pink



146481
starlet dress



146766
autumn leaf



146792
fuchsia lily



146793
passionnement



146425
sweet heart

LAQUÉS LACQUER PRODUCTS

GEL DE COULEUR UV & LED COLOR IT COLOR IT COLOURED UV & LED NAIL GEL

5g - polymérisation / polymerization 30s LED = 2 min UV



146460
princess chic



146461
fairy queen



146441
dark fuchsia



146889
cassis



146439
ultra violet



146778
plum tribute



146448
plumy reverie



146784
happy lavender



146491
wedding day



146490
bachelorette



146456
sable stone



146455
taupe show



146814
hypnotic violet



146454
nightfall



146805
jean attitude



146788
blue perspective



146483
sailing yacht

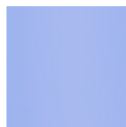

146443
baby shower



146445
perfect day



146444
tropical mint



146780
joyful jade



146482
jungle fever



146433
Jasmine



146808
sorbet curaçao



146488
cloudy moon



146489
crossfit kaki



146435
cosy camel



146487
precious brown



146779
chocolate crush



146905
spy beige



146898
modern grey



146893
nutty brown



146783
juicy melon



146422
peach melba



146474
arty gallery



146833
canari twist



146478
sunglasses



146479
pump it up



146829
punch orange



146473
floral mood



146451
papaya diva



146913
fresh corail



146421
tempting oasis



146904
fantastic red



146930
neon pink



146937
neon coral

**GEL DE COULEUR UV & LED COLOR IT
COLOR IT COLOURED UV & LED NAIL GEL**

5 g - polymérisation / polymerization 30 s LED = 2 min UV

**LAQUÉS
LACQUER PRODUCTS**



146472
modern love



146420
Le Rouge



146823
mango satin



146886
crazy cherry



146485
tricky treat



146816
vinyl fraise



146484
lipstick red



146768
Royan



146769
retro tango



146819
sangria party



146820
pretty prune



146887
grenat



146888
tulipe noire



146800
black velours

NACRÉS / PEARL PRODUCTS



146849
French blanc nacré



146836
milky perle



146878
smiling silver



146494
hugs & kisses



146801
marron glacé



146845
pearly rose



146430
electric candy



146477
candy bar



146906
salsa fuego



146879
diamant cerise



146774
peacock blue



146806
pacific show



146880
sweet violine



146877
gris metropolitan



PAILLETÉS GLITTER PRODUCTS

GEL DE COULEUR UV & LED COLOR IT COLOR IT COLOURED UV & LED NAIL GEL

5g - polymérisation / polymerization 30s LED = 2 min UV



146860
pailleté argent



146870
scintillant argent



146495
forever after



146773
fancy glory

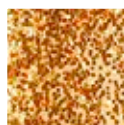

146865
pétillant cannelle



146871
scintillant bronze



146416
eternal sunset



146464
sparkling jewel



146465
lovely unicorn



146322
royal princess



146323
fairy's legend



146417
falling star



146418
diamond ring



146872
scintillant rose



146777
pink celebration



146453
fuchsia pop



146882
astral pink



146873
scintillant rouge



146798
radiant red



146863
pétillant blanc reflets rose/vert



146320
mysterious lake



146321
dream ocean



146869
pétillant noir



146876
scintillant noir

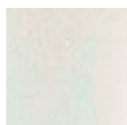

146854
French blanc pailleté



146899
white cotton



146436
mitten gray



146496
way of love



146457
dolly prtty



146929
scintillant nude argent



146928
scintillant nude or



146459
sweet marsala



146916
sweet corail



146452
coral bubble



146832
shiny pêche



146450
pinky galaxy



146449
rosy fantasy



146826
pink cerise



146817
bloody rouge



146486
dusky mauve



146771
cobalt prism



CABO VERDE
NO STRESS

technigel

waterway

NEW

TUTO / TUTORIAL
ON LINE



146130
transparent base



146131
white base



BASE UV & LED POUR ONGLES WATERWAY WATERWAY UV & LED NAIL GEL BASE

5 g - polymérisation 30 s LED = 2 min UV / polymerization 30 s LED = 2 min UV



146132
yellow

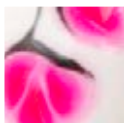

146133
pink



146134
red



146135
purple

GEL UV & LED POUR ONGLES WATERWAY

Prélever le gel de couleur Waterway choisi à l'aide d'un pinceau Nail art ultra fin. Dessiner vos motifs de Nail art. Attendre quelques secondes afin que le motif se disperse.

WATERWAY UV & LED NAIL GEL

Take up your chosen colour of Waterway gel with an ultra-fine nail art brush. Paint on your nail art designs. Wait for a few seconds for the pattern to spread.

5 g - polymérisation 30 s LED = 2 min UV / polymerization 30 s LED = 2 min UV



146136
violet



146137
blue



146138
green



146139
turquoise

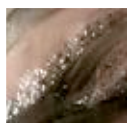

146140
black



146141
white



technigel

plastigel

NEW

GEL UV&LED POUR ONGLES PLASTIGEL

Leur texture extrêmement modelable permet de donner du volume à vos poses et de créer les designs de votre choix, notamment des fleurs, dentelles, plumes, nœuds ... particulièrement sophistiqués.

PLASTIGEL UV&LED NAIL GEL

With their highly sculptable texture, these gels give your applications extra volume, enabling you to create a host of incredibly sophisticated designs of your choice, including flowers, lace, feathers, bows and more.

5 g - polymérisation / polymerization 30 s LED = 2 min UV



146596
black



146597
white



146598
red



146599
purple

technigel *paint!*

GEL DE COULEUR UV & LED PAINT

Une nouvelle génération de gels «peinture» UV/LED ultra couvrants aux couleurs intenses pour toutes vos réalisations nail art, dégradés et 1-stroke.

TECHNIGEL COLOR IT PAINT UV/LED COLOURED GEL

A new generation of ultra-covering UV/LED 'paint' gels in intense colours for all your nail art creations, colour graduations and 1-stroke applications.

5 g - polymérisation / polymerization 30 s LED = 2 min UV



146938
splendid moon



146939
celestial glow



146940
blizzard white



146941
ebony black



146942
millenium red



146943
manga pink



146944
tea rose



146946
neon coral



146987
sunshine yellow



146988
waterfall blue



146989
ocean navy

technigel *cat eye*



146976
synergy



146977
galaxy



146978
silvery



146979
smoky



103019

GEL DE COULEUR UV & LED CAT EYE

Appliquer le gel cat eye, puis passer délicatement l'aimant cat eye au-dessus de l'ongle sans le toucher afin de créer le motif "œil de chat".

UV&LED CAT EYE NAIL GEL

Apply the cat eye gel and then carefully pass the magnet over the nail without touching it to create your 'cat's eye' pattern.

5 g - polymérisation 30 s LED = 2 min UV / polymerization 30 s LED = 2 min UV

AIMANT DOUBLE POUR GEL CAT EYE DOUBLE-ENDED CAT EYE MAGNET

103019



O N G L E S / N A I L S

G E L S C U L P T

Peggy Sage a réuni le meilleur du gel et de la résine pour créer le Gel Sculpt : la construction d'ongle la plus résistante !

Flexible et léger, ce polymère hybride se travaille à l'infini avant catalysation.

Sa texture unique sous forme de pâte s'applique facilement. Pratique, le gel sculpt convient à tous les professionnels.

Peggy Sage has combined the best of gel and acrylic resin to create Gel Sculpt, the most hardwearing nail construction technique!

Flexible and light, this hybrid polymer can be worked for as long as you like before catalyzing. Its unique paste texture is easy to apply. Gel Sculpt is extremely practical and suitable for all professionals.

GEL SCULPT

GEL SCULPT LIQUID

Indispensable pour travailler votre matière Gel sculpt aussi longtemps que vous le souhaitez.

The essential addition, enabling you to work your Gel sculpt material for as long as you like.

189010 - 240 ml

GEL SCULPT BRUSH CLEANER

S'utilise pour nettoyer et préserver votre instrument double Gel sculpt 189015
For cleaning and looking after your Gel sculpt dual-function instrument 189015.

189011 - 240 ml



BASE GEL SCULPT

S'applique en couche fine pour une adhérence parfaite Gel Sculpt tout en protégeant l'ongle naturel.

GEL SCULPT BASE

Apply a thin coat to ensure a perfect hold for the Gel Sculpt while protecting the natural nail.

Polymérisation 30 s LED = 2 min UV / polymerization 30 s LED = 2 min UV

189012 - 11 ml

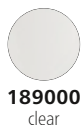

189000
clear

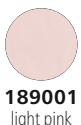

189001
light pink



GEL SCULPT

56 g - polymérisation / polymerization 60 s LED = 2 min UV



189002
dark pink



189003
bright white

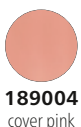

189004
cover pink



INSTRUMENT DOUBLE GEL SCULPT

Idéal pour réaliser vos poses de Gel sculpt grâce à son embout spatule permettant de prélever et d'appliquer la matière, et son côté pinceau pour venir la travailler à l'aide du gel sculpt liquid.

GEL SCULPT DUAL-FUNCTION INSTRUMENT

Ideal for all your Gel sculpt applications with its spatula end for taking up and applying the material and its brush side for working the material with Gel sculpt liquid.

189015

INSTRUMENT DOUBLE GEL SCULPT

GEL SCULPT DUAL-FUNCTION INSTRUMENT

189016



NEW

189016

189015

CAPSULES PROFESSIONNELLES

Capsules moules pour gel sculpt et résine. Appliquer la matière directement à l'intérieur de la capsule pour une forme parfaite et la longueur que vous souhaitez. Catalyser (gel sculpt) ou laissez sécher (résine) puis décoller la capsule.

PROFESSIONAL TIPS

Tip moulds for Gel Sculpt and acrylic resin. Apply the material directly to the inside of the tip to create the perfect shape in the length you want. Catalyze (Gel Sculpt) or leave it to dry (acrylic resin) and then remove the tip.

QUICK FORMS

142050 - x100 - 10 tailles / 10 size

POP IT

142051 - x100 - 10 tailles / 10 size - avec graduation / with gradation



142050

142051

NEW

STARTER KIT GEL SCULPT

Un joli coffret comprenant un tube de gel sculpt clear 56g + un flacon de gel sculpt liquid 240ml + un instrument double spatule / pinceau 189015 à un prix attractif pour découvrir la gamme Gel sculpt.

An attractive box set containing one tube of Gel sculpt Clear, 56 g + one bottle of Gel sculpt liquid, 240 ml + one dual-function spatula/brush instrument 189015 all for a great price, to help you get started with the Gel sculpt range.

189019



Résistant, flexible et léger sur l'ongle.

Application et mise en place facile, nécessite peu de limage.

Ne durcit pas tant qu'il n'a pas été catalysé sous une lampe (UV ou LED) ce qui vous permet de travailler à votre rythme.

Hardwearing, flexible, light on the nail.

Easy to apply and position, little filing required.

Does not harden fully until it is catalyzed under a lamp (UV or LED), enabling you to work at your own pace.





O N G L E S / N A I L S

S C U L P T I N G +

Une gamme acrylique performante issue de l'expertise de Peggy Sage.

Formule unique et innovante combinant une poudre fine et un liquide monomère pour un façonnage précis et un séchage rapide à l'air libre. La résine est ultra résistante et vous offre une tenue par excellence sur les ongles.

A high-tech acrylic range developed with Peggy Sage expertise.

This innovative, unique formula combines a fine powder with a monomer liquid for precise sculpting and fast air drying. The resulting resin is ultra-hardwearing and ensures an excellent hold on the nail.

sculpting⁺

NAIL PREP SCULPTING+

Purifie et dégraisse l'ongle naturel. S'applique comme un vernis avant l'application de résine acrylique, capsules et gel UV.

SCULPTING + NAIL PREP+

Sanitizes and degreases natural nails. Applied just like a nail lacquer, before applying acrylic resin, tips or UV gel.

145180 - 15 ml



PRIMER SCULPTING+

S'applique avant toute pose pour assurer l'adhérence de la résine Sculpting +.

SCULPTING + PRIMER

Applied as a base coat to ensure a good hold for the Sculpting + acrylic resin.

145181 - 15 ml

PRIMER ADHESION + SCULPTING +

S'applique avant toute pose pour améliorer l'adhérence de la résine Sculpting +, spécialement créé pour les ongles ayant des problèmes d'adhérence.

SCULPTING + STRONG HOLD PRIMER

Applied as a base coat to improve the hold of the Sculpting + acrylic resin. Specially created for nails where hold is a problem.

145182 - 15 ml





extra blanche



cristal



nude rose



nude peach



cristal rose

POUDRE DE FAÇONNAGE SCULPTING +

Ultra fine, solide et flexible à la fois, elle absorbe parfaitement le liquide de façonnage pour une mise en place facile et un modelage de haute qualité.

SCULPTING + POWDER

Ultra-fine, hard and flexible at the same time, this sculpting powder readily absorbs sculpting liquid for easy application and high-quality nail sculpting.

145150 - 10g	145151 - 45g	145152 - 180g	extra blanche
145155 - 10g	145156 - 45g	145157 - 180g	cristal
145160 - 10g	145161 - 45g	145162 - 180g	nude peach
145165 - 10g	145166 - 45g	145167 - 180g	nude rose
145170 - 10g	145171 - 45g	145172 - 180g	cristal rose

FRENCH CUTTER

Permet de réaliser une ligne du sourire parfaite en un temps record lors d'une French en résine acrylique.
Use this trimmer to produce a perfect smile line in record time when creating an acrylic resin French manicure.

145300



LIQUIDE DE FAÇONNAGE SCULPTING +

Ultra-rétenantif, le liquide Sculpting + permet un contrôle optimal pour un modelage parfait et une adhérence longue tenue.

SCULPTING + SCULPTING LIQUID

This extremely absorbent Sculpting + liquid gives you total control for perfect nail sculpting and a long-lasting hold.

145190 - 10 ml

145191 - 60 ml

145192 - 120 ml

145193 - 240 ml

145194 - 500 ml

145195 - 2 x 500 ml



240 ml

120 ml

60 ml

10 ml



500 ml



2 x 500 ml



MINI KIT RÉSINE SCULPTING +

2 poudres de façonnage 45 g extra-blanche 145151 et camouflage nude rose 145166 + 1 liquide de façonnage 60 ml + 1 nail prep 145180 + 1 primer 145181 + 1 lime 2 faces dure 122080 + 50 formes 140005 + 1 pinceau résine Roubloff 141012

SCULPTING + ACRYLIC MINI KIT

2 sculpting powders, 45 g: extra-blanche 145151 and nude rose cover-up 145166 + 1 sculpting liquid, 60 ml + 1 nail prep 145180 + 1 primer 145181 + 1 2-way coarse nail file 122080 + 50 forms 140005 + 1 Roubloff acrylic resin brush 141012

150017 - 28 x 6,5 x 14,5 cm

DIP In +



O N G L E S / N A I L S

D I P I N +

L'essentiel de la résine dans un kit complet pour une manucure rapide et ultrarésistante !
N'avez-vous jamais rêvé d'une manucure express et ultrarésistante sans utiliser de lampe ?
Cela est désormais possible avec la pose de résine par trempage !

The essential resin in a complete kit for a fast, ultra-hardwearing manicure!
Have you always wanted to create a super-fast, ultra-hardwearing manicure without needing a lamp?
Now you can, using this resin soaking method.

DIP IN + BASE 1

La base 1 permet à la poudre d'adhérer à l'ongle. Après le nail prep Sculpting +, appliquez la base 1 Dip in + sur l'ongle, sans toucher les cuticules, avant de plonger l'ongle dans la poudre. Mit Hilfe der Basis 1 haftet der Puder am Nagel. Base 1 enables the powder to adhere to the nail. After applying Sculpting + nail prep, apply Dip in + Base 1 to the nail without touching the cuticles and then dip the nail into the powder.

145010 - 14,2g

DIP IN + ACTIVATOR 2

L'activator 2 s'utilise pour sécher la base, il apporte solidité et flexibilité à vos ongles, et vous permet de les mettre en forme.

Activator 2 dries the base, giving your nails extra strength and flexibility, and enables you to shape them.

145011 - 14,2g



TUTO / TUTORIAL
ON LINE



DIP IN + TOP 3

Le top coat 3 s'utilise comme finition pour la pose du système Dip in + et protège votre manucure en résine Dip in +.

Top coat 3 is used as a finish on top of your Dip in + application and to protect your Dip in + resin manicure.

145012 - 14,2g

DIP IN + BRUSH CLEANER 4

Le brush cleaner 4 s'utilise lorsque le pinceau de votre base ou Top se durcit durant la pose. Placer le pinceau en question dans le flacon du brush cleaner 4 et laisser agir 5 à 10 minutes.

Brush cleaner 4 is there for when the brush you are using to apply your base or top coat starts to harden during application. Simply place the brush in the Brush cleaner 4 bottle and leave it to work for 5 to 10 minutes.

145013 - 14,2g

RÉCIPIENT POUR RÉSINE DIP IN + DIP IN + ACRYLBAKJE

145009



KIT DIP IN +

Nail Prep sculpting + 15ml 145180, Dip in + base 1 14,2g 145010, Dip in + activator 2 14,2g 145011, Dip in + top 3 14,2g 145012, Dip in + brush cleaner 4 14,2g 145013, poudre de façonnage extra-blanche 10g 145150, cristal 45g 145156, huile soin intensif énergisante 11 ml 120067, top coat gel effect 11 ml 120047, recipient dip in 145009, mini lime neon 122115.

DIP IN + SET

Sculpting + nail prep 15ml 145180, Dip in + base 1 14,2g 145010, Dip in + activator 2 14,2g 145011, Dip in + top 3 14,2g 145012, Dip in + brush cleaner 4 14,2g 145013, extra white sculpting powder 10g 145150, crystal 45g 145156, energizing intensive care oil 11 ml 120067, gel-effect top coat 11 ml 120047, Dip-in + container 145009, neon mini-nail file 122115.

145015



ONGLES / NAILS

SCULPTING+ COULEUR / COLOUR

Embellir vos créations nail art en résine ou dip in grâce à nos couleurs lumineuses !
Adapter la manucure à votre style et celui de vos clients avec les couleurs sculpting aux tons pastels
ou pailletés pour un résultat éclatant !

Beautify your resin and Dip In nail art creations with our bright colours!
Tailor the manicure to your and your client's preferred style with these Sculpting colours in pastel
and glitter shades, for stunning results!

sculpting⁺

POUDRE DE FAÇONNAGE SCULPTING+

Peggy Sage présente ses poudres de façonnage, ultra fines aux couleurs attrayantes et tendance pour toutes vos créations nail art ! Parfaites en French ou en déco 3D, elles s'utilisent avec les liquides de façonnage Sculpting+ Peggy Sage pour une infinité de décors !

SCULPTING POWDER

Peggy Sage presents a range of ultra-fine sculpting powders in attractive, trendy colours for all your nail art creations. Perfect for French manicures and 3D decorations, they are for use with Peggy Sage Sculpting+ sculpting liquids – the possibilities are endless!

10g



LAQUÉES LACQUER PRODUCTS



145320
pastel milky



145382
pastel vanilla



145380
sandy walk



145381
milky coffee



145378
fair nude



145321
pastel rosy



145379
silken pink



145306
pinky story



145313
fuchsia aloha



145314
rosy cherry



145327
neon coral



145328
neon pink



145370
lovely cherry



145315
ruby red



145303
red hibiscus



145326
neon orange



145390
marine coral



145316
orangeade

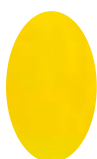

145317
sunny day



145325
neon yellow

LAQUÉES LACQUER PRODUCTS



POUDRE DE FAÇONNAGE SCULPTING+ SCULPTING POWDER

10g

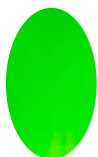

145324
neon green



145318
green leaf



145304
Jasmine



145323
pastel baby



145322
pastel mauvy



145312
lila mania



145307
lilalala



145329
neon violet

NEW



145383
royal cassis



145311
navy sea



145377
city life



145376
urban day



145310
blacky

**POUDRE DE FAÇONNAGE SCULPTING+
SCULPTING POWDER**

10g

**NACRÉES
PEARL PRODUCTS**



PAILLETÉES / GLITTER PRODUCTS





ONGLES / NAILS

VERNIS À ONGLES / NAIL LACQUER

Le vernis à ongles pour les professionnels et les adeptes de la manucure.

Notre formule de vernis à ongle professionnel vous offre une application facile, un temps de séchage rapide, une brillance éclatante et une tenue optimale. Le large choix de couleurs et d'effets vous permettent des looks à l'infini !

The nail lacquer for professionals and manicure addicts.

Our professional nail lacquer formula gives you easy application, a short drying time, a stunning gloss and an optimum hold. And with the vast choice of colours and effects on offer, the options are endless!



BASE TRANSPARENTE

Protège et embellit l'ongle. Accroît la tenue du vernis à ongles.

CLEAR BASE COAT

Protects and embellishes nails. Improves nail lacquer hold.

120003 - 11 ml

121003 - 68 ml



11 ml



68 ml



TOP COAT

Top coat accentuant la brillance et la couvrance du vernis tout en améliorant sa tenue.

Top coat that boosts the gloss and cover of lacquer, improving its hold at the same time.

146015 - 11 ml

BASE COAT / TOP COAT

Comme base coat, ce produit renforce l'adhérence du vernis sur l'ongle et améliore sa tenue. Comme top coat il protège le vernis de l'écaillage et de l'usure tout en apportant de la brillance.

As a base coat, this product increases the adhesion of the nail lacquer to the nail and improves its hold. As a top coat it protects nail lacquer from flaking and wear, while increasing its shine.

120089 - 11 ml





GLOSSY TOP COAT

Sa formule ultra-brillante exalte la beauté naturelle de l'ongle et rehausse l'éclat du vernis pour un effet laqué vinyl.

Its ultra-shiny formula enhances the nail's natural beauty and increases the shine of nail lacquer, creating a vinyl lacquer effect.

120088 - 11 ml



EXPRESS DRY TOP COAT

Donne un fini brillant à votre vernis à ongles en un temps record.

Gives your nail lacquer a super-shiny finish in record time!

120130 - 11 ml



TOP COAT MAT

Sa formule mate transforme votre vernis brillant en teinte mate.

MATT TOP COAT

Its matt formula transforms your glossy lacquer into a matt colour.

120094 - 11 ml



TOP COAT GEL EFFECT

Sa formule à la texture plus épaisse donne un fini brillant à votre vernis à ongles, tout en prolongeant sa tenue.

GEL-EFFECT TOP COAT

Its formula creates a thicker texture, giving your nail lacquer a glossy finish and prolonging its hold.

120047 - 11 ml

GEL UP TOP COAT UV&LED

Prodigieux: transforme votre vernis à ongles en semi-permanent pour un résultat ultra glossy.

Mode d'emploi: appliquer une base puis 2 couches de votre vernis à ongles Peggy Sage. Une fois votre vernis parfaitement sec, appliquer 1 couche de gel up top coat sans toucher les cuticules, catalyser 60s sous lampe LED (2 min sous UV), dégraisser.

UV&LED GEL UP TOP COAT

This amazing product transforms your nail lacquer into a semi-permanent lacquer, for ultra-glossy.

Instructions: apply a base followed by 2 coats of your Peggy Sage nail lacquer. Once the lacquer is thoroughly dry, apply a coat of gel up top coat, being careful not to touch the cuticles, catalyze for 60 seconds under an LED lamp (2 minutes under UV) and then degrease.

120132 - 11 ml







VERNIS À ONGLES
NAIL LACQUER
11 ml

LAQUÉS
LACQUER PRODUCTS

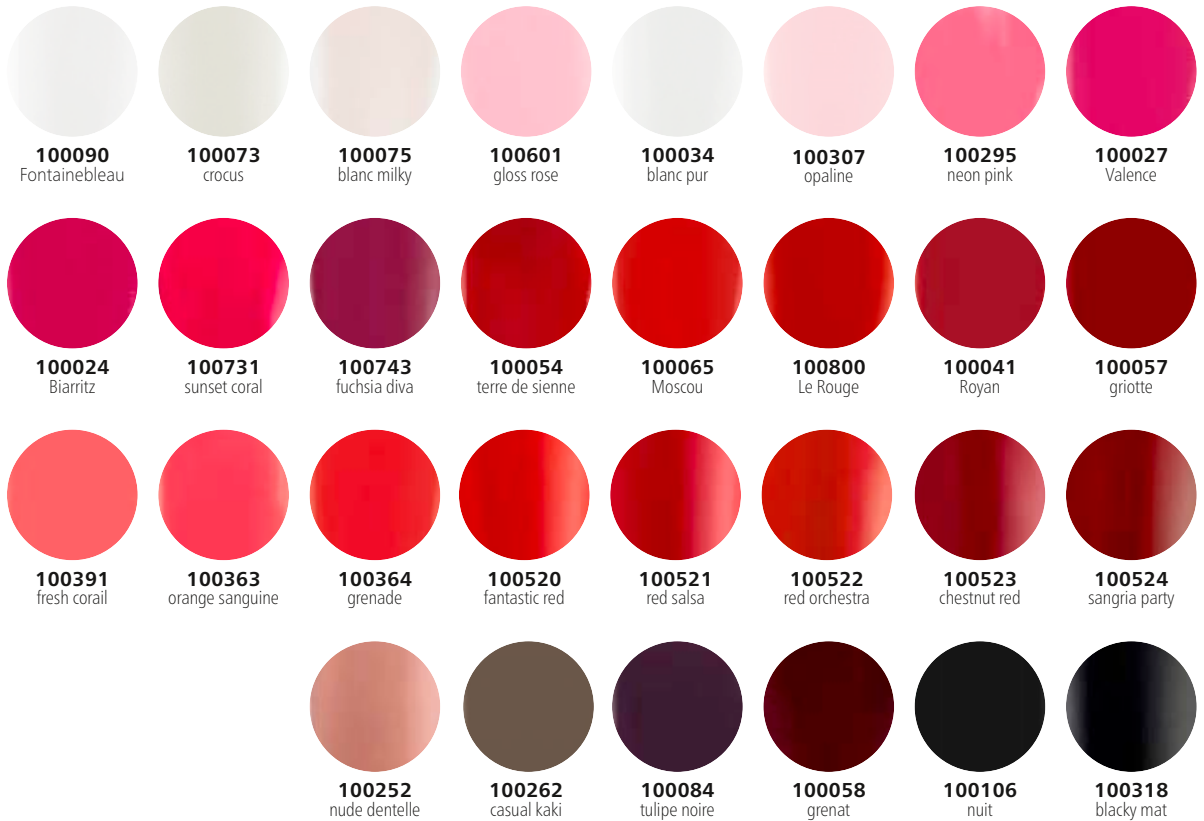

NACRÉS
PEARL PRODUCTS

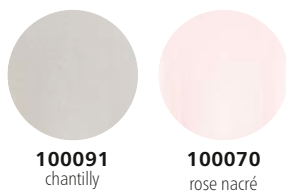



120018
French blanche



100136
French eau de rose



100137
French pink



100145
French nude rose

**VERNIS À ONGLES FRENCH MANUCURE
FRENCH MANICURE NAIL LACQUER**

11 ml



PROTECT' LIGHT

S'adapte parfaitement à toute pose de French manucure. Apporte de la brillance aux teintes claires en les protégeant.

Perfectly suited to any French manicure application. Gives a glossy sheen to light colours and protects at the same time.

120035 - 11 ml



CRAYON BLANC POUR ONGLES

WHITE PENCIL FOR NAILS

120007 - 1,3 g

taille-crayon / pencil sharpener 130280/130283

STYLO FRENCH MANUCURE & NAIL ART

Sa mine précise vous permet de dessiner une French manucure parfaite ou les décors les plus créatifs. Séchage rapide et longue tenue.

FRENCH MANICURE & NAIL ART PEN

Can be used to draw a perfect French manicure and for even the most creative decorations thanks to its accurate tip. Quick drying and long lasting hold.

120910 - blanc - 3 ml

120912 - noir - 3 ml



blanc

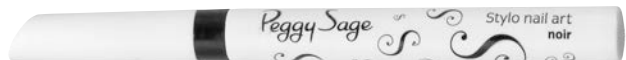

noir



PINCEAU FRENCH

Spécial ligne du sourire.

FRENCH MANICURE BRUSH

Smile line brush.

141095

KIT FRENCH MANUCURE

Chaque kit contient :
1 vernis 11 ml au choix 100136, 100137,
1 vernis blanc pur 11 ml 100034,
1 protect'light 11 ml 120035,
20 papiers contours 120020,
1 mode d'emploi.

FRENCH MANICURE KIT

Each kit contains a choice of :
1 x 11 ml nail lacquer (100136, 100137)
1 blanc pur lacquer 11 ml (100034)
1 Protect'light 11 ml (120035)
20 paper guides (120020)
1 instruction sheet.

120136 - eau de rose

120137 - diamant pink

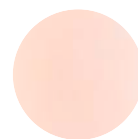

120136



120137



120020 - x40



120085 - x40

PAPIERS CONTOURS

PAPER GUIDES

120020 - x40

120085 - x40



ONGLES / NAILS

MINI VERNIS À ONGLES / NAIL LACQUER

Compléter votre collection avec nos mini-verniss et leur multitude de couleurs !
Ces petits formats vous permettent de changer régulièrement la couleur de votre manucure au gré des tendances.
À emporter partout avec vous pour une retouche express !

Complete your collection with our mini nail lacquers in a host of colours!
With these smaller sizes, you can change the colour of your manicure more often to keep up with the trends
and take it anywhere for a quick touch-up!

BB NAIL

Votre meilleur allié pour des ongles parfaits ! L'élixir BB Nails embellit vos ongles tout en les rendant plus durs et résistants aux chocs. Ce soin à base d'acides aminés énergisants, de vitamine E, d'extrait de violette antioxydants, d'huile de baobab et d'argan lisse la surface des ongles et les fait briller. S'applique 2 fois par semaine, en 2 couches, sur l'ongle nu en partant de la base jusqu'à son extrémité.

Your best friend for perfect nails! This BB Nails elixir beautifies your nails and hardens them at the same time, making them more shock-resistant. This nail treatment containing energizing amino acids, antioxidant vitamin E and violet extract, baobab oil and argan oil smooths the nail surface and gives it a glossy finish. Apply 2 coats twice a week to bare nails, starting at the base and working up to the tip.

105650 - 5 ml



Existe aussi en 11 ml
Also available in 11 ml
p. 79 - 120650



EXPRESS BASE MINI

Base à séchage rapide pour protéger et embellir l'ongle. Prolonge également la tenue de votre vernis à ongles.

MINI EXPRESS BASE

A quick-drying base that protects and beautifies your nails. It also prolongs the hold of your nail lacquer.

105600 - 5 ml

BASE PEEL-OFF MINI

Idéale pour les vernis très pigmentés et/ou pailletés, la base peel-off permet de retirer le vernis en un tour de main sans dissolvant ni coton et sans abîmer l'ongle.

MINI PEEL-OFF BASE

Ideal for highly pigmented and/or glitter nail lacquers. With peel-off base you can remove lacquer in a trice without nail lacquer remover or cotton wool and without damaging the nail.

105603 - 5 ml



BRILLIANT TOP COAT MINI

Vernis de finition qui accentue l'éclat du vernis à ongles et prolonge sa tenue.

MINI BRILLIANT TOP COAT

Finishing lacquer that improves the shine and hold of nail lacquer.

105601 - 5 ml



IT-Color

VERNIS À ONGLES MINI IT-COLOR

Formule conciliant la meilleure alliance entre brillance, tenue, application et temps de séchage !

IT-COLOR MINI NAIL LACQUER

The best combination of gloss, hold, application and drying time!

5ml



LAQUÉS LACQUER PRODUCTS



105000
Blanche



105030
Cynthia

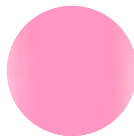

105014
Lou-Ann



105059
Alicia



105017
Barbara



105060
Laurine



105018
Anna

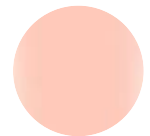

105012
Noémie



105037
Madeleine

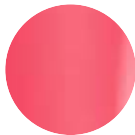

105047
Nelly



105058
Mila



105020
Joséphine

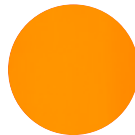

105050
Annabelle

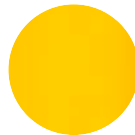

105049
Bérénice



105048
Marion



105002
Jasmine

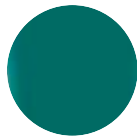

105006
Marie



105007
Tiphaine



105051
Magalie



105022
Mélanie

NACRÉS / PEARL PRODUCTS



105032
Tatiana



105025
Ludivine



quick
dry

A
P

16

eagles

Quick dry

VERNIS À ONGLES MINI QUICK DRY

Le vernis à ongles "on the go" !
Assortissez votre vernis à votre tenue en un tour de main grâce à sa formule
à séchage ultra-rapide en 60 secondes !

QUICK DRY MINI NAIL LACQUER

The nail lacquer for when you're on the go!
Match your nail lacquer with your outfit in a trice thanks to
its ultra-quick-drying formula!

5 ml



LAQUÉS LACQUER PRODUCTS



105247
Domy



105249
Kate



105250
Emma-Lee



105255
Claudie



105256
Vicky



105257
Lauren



105259
Kymie



105260
Léane



105233
Adriana

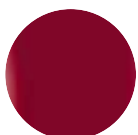

105221
Mathilde



105225
Amélie

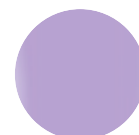

105208
Émilie

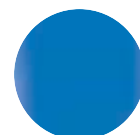

105204
Pauline



105252
Zélie



105253
Flavie

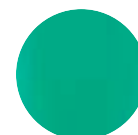

105202
Éva



105251
Leslie



105223
Justine



105258
Cléa

NACRÉS PEARL PRODUCTS



105217
Abigaël



105216
Elena

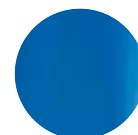

105205
Marine



105254
Jeanne

PAILLETÉS GLITTER PRODUCTS



105248
Carole



105235
Julie



105261
Bella

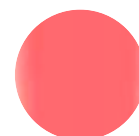

105218
Emma



NEVER

A SMOOTH

MAN... SKILL

Perfect lasting

VERNIS À ONGLES MINI PERFECT LASTING

Apprécier sa formule longue tenue et son pinceau large légèrement arrondi pour une application impeccable et une manucure parfaite et longue durée.

PERFECT LASTING MINI NAIL LACQUER

You'll love its long-hold formula and broad, slightly rounded brush for impeccable application and a perfect manicure.

5 ml



LAQUÉS LACQUER PRODUCTS



PAILLETÉES GLITTER PRODUCTS



NACRÉS PEARL PRODUCTS

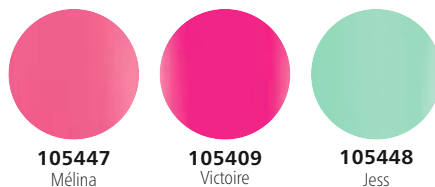



COLOR IS LIFE



PROTECTIVE BASE MINI COLOR IS LIFE
MINI PROTECTIVE BASE COLOR IS LIFE
 105550 - 5ml



65-75%
Ingrédients d'origine naturelle
Naturally sourced ingredients

Découvrir des vernis à ongles innovants inspirés par les couleurs de la nature.

Une formule nouvelle génération contenant entre 65 et 75% d'ingrédients d'origine naturelle, sans aucun compromis sur le séchage, la brillance et la tenue !

Check out our range of innovative nail lacquers inspired by the colours of nature.

A new-generation formula containing between 65 and 75% of naturally sourced ingredients, without compromising on drying time, gloss or hold!



PROTECTIVE TOP COAT MINI COLOR IS LIFE
MINI PROTECTIVE TOP COAT COLOR IS LIFE
 105551 - 5ml

VERNIS À ONGLES MINI COLOR IS LIFE
COLOR IS LIFE MINI NAIL LACQUER
 5ml



105558
 Marjolaine



105568
 Ondine



105567
 Gaia



105566
 Fleur



105565
 Rosalie



105559
 Daisy



105560
 Camélia

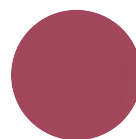

105561
 Lily



105562
 Garance

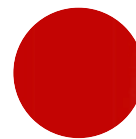

105563
 Daphné



105564
 Violette



105569
 Silvia

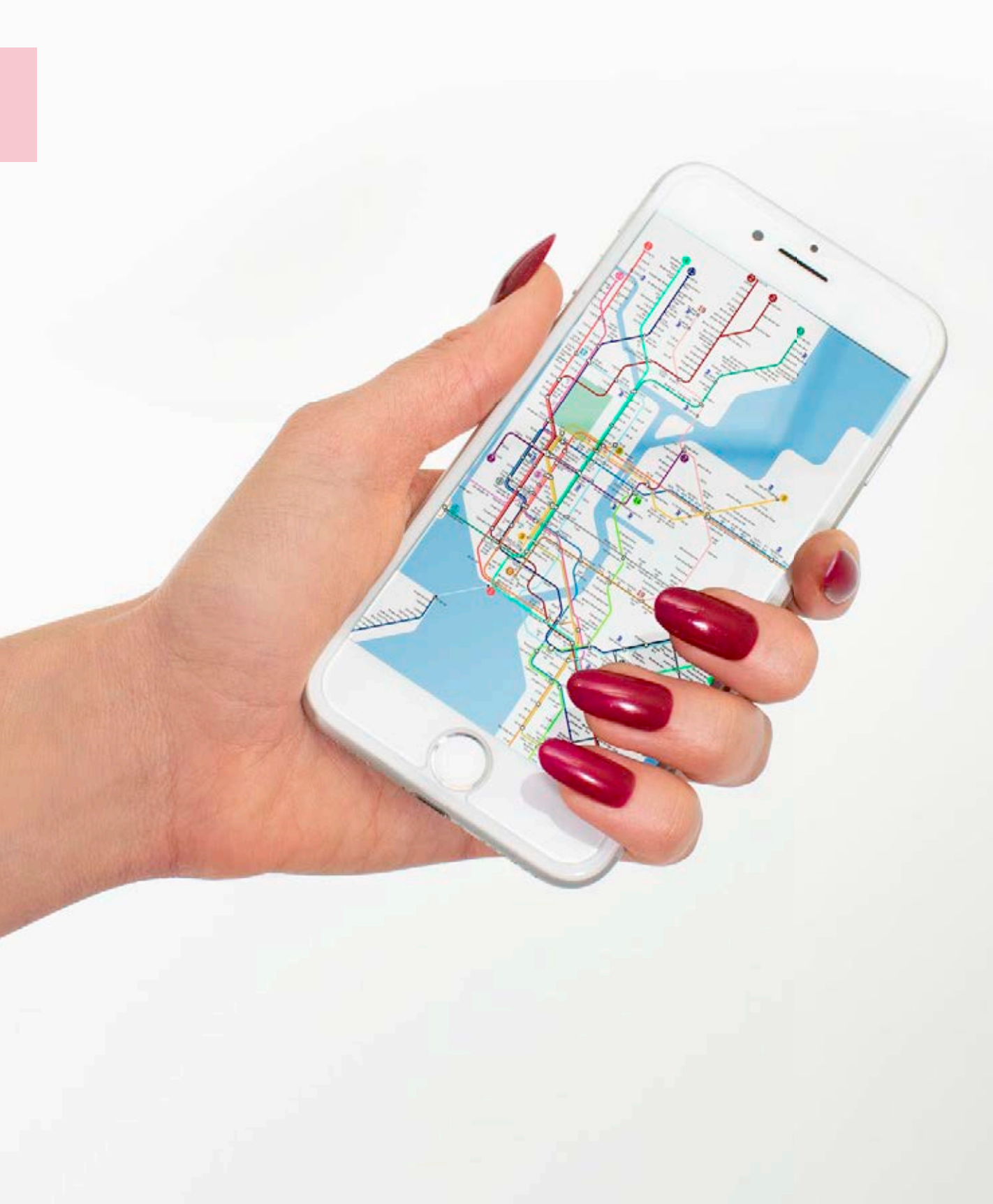

| TIMELESS STYLE

VERNIS À ONGLES MINI

Une formule classique pour un style intemporel.
Obtenir une manucure soignée pour tous les jours grâce aux vernis à ongles timeless style.

FRENCH MINI NAIL LACQUER

A classic formula for a style that never goes out of fashion. Create a classy everyday manicure with the Timeless Style nail lacquers.

5 ml



105302
French - Angelica

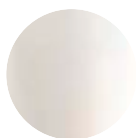

105303
French - Candice



105802
Lola



105805
Amanda



105808
Tessa



105803
Tania



105592
red passion



105971
Merry

PAILLETÉS GLITTER PRODUCTS



NEW

105680
Céleste



NEW

105681
Astrée



NEW

105683
Oriane



105594
haute couture



105772
cosmic grey



NEW

105682
Éline



105771
diamond dust



105590
lux goddess



105591
beauty queen



105593
red ceremony



Kids

MINI VERNIS À ONGLES KIDS POUR ENFANTS

Tout comme les grandes !
Peggy Sage a pensé aux mini fashionistas et a lancé sa gamme kids: vernis à ongles ludiques aux couleurs vives et attractives pour les petites coquettes. Formule à l'eau spéciale enfant. Se retire sans dissolvant, un simple lavage de mains suffit.
Ne pas utiliser chez les enfants de moins de 3 ans.

MINI NAIL LACQUER KIDS

Just like a grown-up! With its brand new kids' range, Peggy Sage now offers something for budding fashionistas: fun nail lacquers for little misses in bright, attractive colours. Child-friendly water-based formula. Comes off without nail lacquer remover – just wash your hands!
Do not use in children under the age of 3 years.

5ml



105902
Mindy

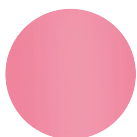

105901
Wendy



105912
Iris



105913
Mia



105914
Lina



105915
Kayla



105916
Sharlene



105905
Grace



105917
Tina



105904
Elsa

PAILLETÉS GLITTER PRODUCTS



105906
Bianca

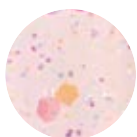

105907
Betty

NACRÉS PEARL PRODUCTS



105908
Rosie



105900
Leia



105903
Mélusine



105910
Sofia



O N G L E S / N A I L S

F O R E V E R L A K

Le vernis à ongles hybride longue tenue.
Ce vernis à ongles sèche rapidement à l'air libre.
Il offre une longue tenue et une brillance intense à votre manucure.

The long-hold hybrid nail lacquer.
This nail lacquer air dries quickly.
It has a long hold and gives your manicure an intense shine.

Forever LAK

BASE COAT FOREVER LAK

Spécialement formulée, elle protège, renforce l'ongle et prolonge la tenue de votre vernis à ongles Forever LAK.

BASE COAT FOREVER LAK

This specially formulated base coat protects and strengthens the nail and prolongs the hold of your Forever LAK nail lacquer.

108100 - 11 ml



TOP COAT FOREVER LAK

Donne un volume et une brillance longue durée à votre vernis à ongles Forever LAK.

FOREVER LAK TOP COAT

Adds volume and long-lasting shine to your Forever LAK nail lacquer.

108101 - 11 ml

Mettre en forme les ongles, appliquer la base Forever Lak, 2 couches de couleur Forever Lak. Laisser sécher et finaliser par 1 couche de top coat Forever Lak pour une brillance intense, 2 couches pour un effet gel, ultra-volume.

Shape your nails and apply Forever Lak base, followed by two coats of Forever Lak colour. Leave them to dry and finish off with 1 coat of Forever Lak top coat for an intense gloss or 2 coats for an ultra-volumizing gel effect.

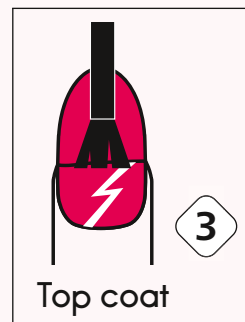
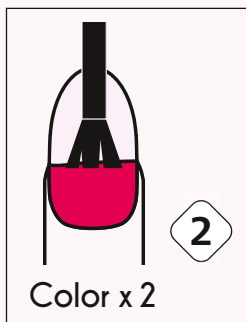
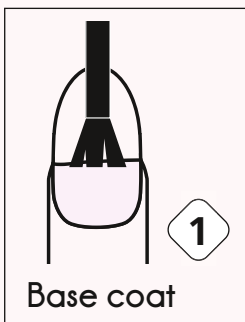



VERNIS À ONGLES FOREVER LAK

Découvrez des laques intenses à la texture riche et à l'application aisée grâce à leur pinceau large. S'applique en 2 couches pour une couvrance optimale.

FOREVER LAK NAIL LACQUER

Check out this intensely coloured and richly textured nail lacquer, easy to apply with its broad brush. Goes on in 2 coats for optimum coverage.

11 ml

LAQUÉS LACQUER PRODUCTS





NACRÉS / PEARL PRODUCTS

VERNIS À ONGLES FOREVER LAK

Découvrez des laques intenses à la texture riche et à l'application aisée grâce à leur pinceau large. S'applique en 2 couches pour une couvrance optimale.

FOREVER LAK NAIL LACQUER

Check out this intensely coloured and richly textured nail lacquer, easy to apply with its broad brush. Goes on in 2 coats for optimum coverage.

11 ml



108036
bridal party

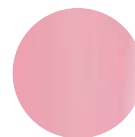

108040
honey moon



108043
sunrise chill



108068
pinkalicious



108050
sweet romance



108052
passion berry



108053
royal love



ONGLES / NAILS

SOIN DES ONGLES / NAIL CARE

Prendre soin de vos ongles est essentiel ! Faites-le avec les produits d'une marque experte, Peggy Sage.

Renforcer, embellir, protéger : trouver le produit parfait selon le diagnostic de vos ongles.

Ils retrouveront leur beauté instantanément grâce à notre gamme spéciale soin des ongles !

Taking care of your nails is essential! Look after them with the products from an expert brand: Peggy Sage.

Strengthen, beautify, protect: whatever your nails need,
you'll find the perfect beauty-restoring product in our special nail care range!

NAIL BLUSH

Ce soin bonne mine instantané donne un joli teint à l'ongle en réhaussant la plaque rosée comme le blanc du bord libre. Composé de silicium, vitamine E, provitamine B5, huile d'argan et noix du Brésil.

This instant healthy look nail blush colours your nails prettily, reviving both the pink plate and the white free edge of the nail. Contains silicon, vitamin E, provitamin B5, argan oil and Brazil nut oil.

120651 - 11 ml



PERFECTEUR DE TEINT POUR ONGLES

Pour les personnes qui n'aiment pas porter de vernis à ongles mais qui souhaitent avoir des ongles toujours soignés. Le perfecteur de teint pour ongles unifie la couleur de l'ongle naturel tout en lui apportant éclat et brillance. Pour un look parfait jusqu'au bout des ongles, appliquez en deux couches.

NAIL COLOUR PERFECTOR

For people who don't like wearing nail lacquer but want well groomed nails all the time. Nail colour perfector evens up your natural nail colour, adding a glossy shine. Apply two coats for a perfect look right to your fingertips.

120061 - 11 ml

BB NAIL

Votre meilleur allié pour des ongles parfaits ! L'élixir BB Nails embellit vos ongles tout en les rendant plus durs et résistants aux chocs. Ce soin à base d'acides aminés énergisants, de vitamine E, d'extrait de violette antioxydants, d'huile de baobab et d'argan lisse la surface des ongles et les fait briller. S'applique 2 fois par semaine, en 2 couches, sur l'ongle nu en partant de la base jusqu'à son extrémité.

Your best friend for perfect nails! Combining technological innovation with naturally occurring active ingredients (energizing amino acids, antioxidant vitamin E and violet extract, nourishing baobab and argan oils), BB nail elixir beautifies your nails and has no fewer than 8 actions.

120650 - 11 ml



Existe aussi en 5 ml
Also available in 5 ml
p. 61 - 105650



SOIN ÉCLAT DE L'ONGLE

À base d'huile de l'arbre à thé et d'huile essentielle de citron, ce soin redonne éclat et force à l'ongle.

NAIL RADIANCE BEADS

Containing tea tree oil and lemon essential oil, these beads restore your nails' shine and strength..

120081 - 36 billes effervescentes / 36 effervescent beads

EAU ÉMOLLIENTE
Ramollit et élimine les peaux superflues du contour de l'ongle.

CUTICLE REMOVER

Softens and removes excess skins from around the nail.

121001 - 68 ml

120001 - 11 ml



HUILE FORTIFIANTE

Revitalise et nourrit les ongles fragiles. Parfum abricot.

FORTIFYING OIL

Revitalizes and nourishes fragile nails. Apricot fragrance.

120002 - 11 ml

HUILE "SOIN INTENSIF" ÉNERGISANTE ONGLES ET CUTICULES

Ce mélange exclusif d'huiles d'amande douce, de jojoba, de son de riz, de géranium, de rose, de panthénol et de vitamine E nourrit les ongles et les cuticules.

ENERGIZING "INTENSIVE CARE" OIL FOR NAILS AND CUTICLES

This exclusive mixture of oils of sweet almond, jojoba, rice bran, geranium and rose with panthenol and vitamin E nourishes the nails and cuticles.

120067 - 11 ml



BAUME POUR ONGLES À L'EXTRAIT DE QUINOA

Soigne et assouplit les ongles abîmés.

NAIL BALM WITH QUINOA EXTRACT

Grooms damaged nails, making them more supple.

120080 - 4,5 ml

HUILE CUTICULE

Adoucit et combat le dessèchement des cuticules.

CUTICLE OIL

Softens cuticles and prevents them from drying out.

121000 - 68 ml

120000 - 11 ml



SOIN NOURRISSANT CUTICULES

Format stylo avec applicateur pinceau très pratique, à emporter partout. Sa formule nourrit ongles et cuticules et les protège du dessèchement.

CUTICLE NOURISHER

Designed as a go-anywhere pen with a very practical brush applicator. Its formula, nourishes your nails and cuticles and protects them from drying out.

120077 - 2,2 ml



SOIN EXFOLIANT CUTICULES

Aux extraits de bambou, protéines de soie et vitamine E.

EXFOLIATING CUTICLE CARE PEN

Contains bamboo extracts, silk proteins and vitamin E.

120221 - 2,2 ml



SOIN DE L'ONGLE AU SILICIUM

Cette base soin permet de donner de l'éclat et de la brillance à l'ongle. Il améliore aussi la tenue des vernis.

NAIL CARE LACQUER WITH SILICON

This nail care base gives your nails a glossy shine. It also improves the hold of nail lacquers.

120069 - 11 ml

DURCISSEUR POUR ONGLES
Raffermit et renforce les ongles mous ou dédoublés.

NAIL HARDENER

Hardens and strengthens soft or split nails.

120004 - 11 ml



DURCISSEUR CURE EXPRESS

Renforce rapidement les ongles faibles ou abîmés. S'utilise en cure de 2 semaines : une couche le 1^{er} jour, une deuxième couche le 2^e jour, retirer le tout le 3^e jour et recommencer.

EXPRESS NAIL HARDENER

Quickly reinforces weak or damaged nails. To use in a 2-week treatment: one coat on day 1, a second coat on day 2, then on day 3 remove it all and start again.

120070 - 11 ml

GEL CALCIUM

Ce gel à base de calcium, composant minéral de l'ongle, et à base de vitamine B5 apporte protection et résistance à la surface de l'ongle.

CALCIUM GEL

This gel containing calcium (a mineral component of the nail) and vitamin B5 protects the nail surface and renders it more hardwearing.

120037 - 11 ml



SOIN RÉPARATEUR AUX FIBRES DE NYLON

Sa formule unique composée de fibres de nylon renforce et protège les ongles fragilisés, les rendant plus résistants aux chocs. Ce soin apporte un fini nude discret et raffiné.

NYLON FIBRE NAIL REPAIR TREATMENT

Its unique formula containing nylon fibres strengthens and protects weak nails, making them more shock-resistant. This lacquer gives nails a discreet, sophisticated nude finish.

120039 - 11 ml



120060



120062

STOP ONGLES RONGÉS

Protège l'ongle et stoppe l'habitude de se ronger les ongles et les cuticules en laissant un goût amer.

STOP NAIL BITING

Protects the nails and stops the habit of biting nails and cuticles by leaving a bitter taste.

120060 - 11 ml

ANTI-STRIES

Une formule constituée de minéraux qui lisse et aplanit la surface de l'ongle en comblant les stries et autres irrégularités.

RIDGE FILLER

A mineral-containing formula that smooths out and levels off the nail surface, filling in ridges and other irregularities.

120062 - 11 ml

ANTI-JAUNISSEUR

Rajeunit l'aspect de l'ongle en ravivant sa couleur naturelle.

ANTI-YELLOWING

Makes your nails look younger by reviving their natural colour.

120064 - 11 ml

BASE PEEL-OFF PROTÈGE-CUTICULES

S'applique en couche semi-fine sur le pourtour de l'ongle. Lorsque le produit est bien sec, réalisez votre nail art : dégradé, water marble ou toute autre création...

Une fois votre nail art achevé, retirez la base en pellicule à l'aide d'un bâtonnet manucure ou d'une pince nail art.

CUTICLE PROTECTOR

Apply a moderately thin coat all around the edge of the nail. Once the product is thoroughly dry, proceed with your nail art creation: a graduation, water marbling or any design you like. Once your nail art is complete, pull off the resulting film with a manicure stick or nail art tweezers.

120220 - 11 ml



120220



120064



KIT PANSEMENTS ADHÉSIFS

Contient 7 pansements soie blanche 140001, 1 colle 3 g 146040, 1 mini lime.

ADHESIVE WRAPS KIT

Contains 7 white silk wraps (140001), 1 glue 3 g (146040), 1 mini file.

150060

PANSEMENT SOIE BLANCHE

70 pansements adhésifs pour réparer les ongles cassés ou abîmés. 10 x 7 tailles.

WHITE SILK WRAP

70 adhesive wraps for repairing broken or damaged nails. 10 x 7 sizes.

140001 - x 70



RUBAN DE PANSEMENT SOIE BLANCHE

WHITE SILK WRAP STRIP

140000 - 3x200 cm



COLLE TRANSPARENTE AVEC PINCEAU

Pour capsules et pansements.

CLEAR GLUE FOR TIPS AND WRAPS

With brush.

146049 - 14,17 g

ACCÉLÉRATEUR DE SÉCHAGE

Réduit le temps de séchage du vernis à ongles de moitié.
Quelques gouttes, attendez et le tour est joué.

DRYING ACCELERATOR

Reduces nail lacquer drying. A few drops, a few minutes and it's all set.

120036 - 11 ml

121036 - 68 ml



SPRAY SÉCHANT POUR VERNIS À ONGLES DRYING SPRAY FOR NAIL LACQUER

120010 - 125 ml

120100 - 300 ml

DILUANT POUR VERNIS À ONGLES

Permet de fluidifier les vernis à texture trop épaisse ou qui n'ont pas servi depuis un certain temps.

NAIL LACQUER THINNER

Thins nail lacquers that are too thick or that have not been used for some time.

100000 - 11 ml

121010 - 68 ml





SUPER DÉGRAISSANT

Favorise une bonne tenue du vernis en éliminant toutes les traces d'huile, de crème de soin ou de films gras. Permet une pose parfaite et durable du vernis à ongles. Élimine également la partie collante des gels UV après polymérisation.

SUPER OIL REMOVER

Improves nail lacquer hold by removing all traces of grease, care cream or oily film. Allows a perfect and longlasting nail lacquer application. Also removes the sticky part of UV nail gels after polymerization.

146013 - 11 ml

146014 - 68 ml

120107 - 1L

CLEANSE SPRAY HYGIÉNIQUE

Solution purifiante pour les mains, les ongles et le petit matériel.

CLEANSE HYGIENIC SPRAY

Purifying solution for hands, nails and small equipment.

146010 - 120 ml

146011 - 950 ml



CLEANER TRIPLE ACTION
 Pour ongles naturels, gel UV, pinceaux et matériel. Purifie et dégraisse les ongles naturels. Élimine le film collant du gel UV après polymérisation. Nettoie les pinceaux et autres accessoires.

TRIPLE-ACTION CLEANER

For natural nails, UV gel, brushes and equipment. Degreases natural nails and removes the sticky film on UV gel after polymerization. Cleans brushes and other accessories.

146017 - 115 ml

146018 - 485 ml

146019 - 950 ml



CRAYON CORRECTEUR POUR VERNIS À ONGLES

Contient 3 mines de rechange. Idéal pour redessiner le contour parfait de votre French manucure à main levée après la pose du vernis blanc.

NAIL LACQUER CORRECTION PENCIL

Contains 3 spare leads. Ideal for drawing a perfect edge to your French manicure freehand after applying the white lacquer.

120115 - 4 ml

120116

5 mines de rechange / 5 spare leads



120ml

240ml

950ml

DISSOLVANT EXPRESS

Avec acétone, pour démaquiller les ongles naturels uniquement, en un tour de main : rapide et efficace.

EXPRESS NAIL LACQUER REMOVER

With acetone, for removing lacquer from natural nails only, in a trice: fast and effective.

120108 - 120ml

120109 - 240ml

120110 - 950ml

avec pompe / with pump

BAIN DISSOLVANT DOUX SANS ACÉTONE TWIST AND REMOVE !

Action instantanée. N'hésiter plus à renouveler votre manucure à tout moment ! Élimine toute trace de vernis à ongles en un tour de mains ! Plonger le doigt dans la mousse, tourner et le tour est joué ! Formule sans acétone enrichie en vitamine E et panthénol alliant soin et douceur.

ACETONE-FREE GENTLE NAIL LACQUER REMOVER BATH TWIST AND REMOVE !

Instant action. Now you can have a new manicure at any time! Removes all traces of nail lacquer in a trice! Dip your finger in the foam, turn it and you're done! Acetone-free gentle treatment formula enriched with vitamin E and panthenol.

120118 - 75ml



DISSOLVANT DOUX

Sans acétone, aux protéines de soie.

GENTLE NAIL LACQUER REMOVER

Acetone-free, with silk proteins.

120012 - 68 ml

120113 - 115 ml

120111 - 240 ml
avec pompe / with pump

120013 - 485 ml

120114 - 950 ml



68 ml



115 ml



240 ml



485 ml



950 ml



SERVIETTES DISSOLVANTES

Sans acétone. Le compagnon de voyage idéal : toujours à portée de main dans le sac, elles permettent les petites retouches imprévues.

NAIL LACQUER REMOVING WIPES

Acetone-free. The ideal travelling companion: keep them handy in your bag and use them whenever a touch-up is required.

120011 - boîte de 10 sachets individuels / box of 10 individual sachets



O N G L E S / N A I L S

N A I L A R T



Une gamme complète de décors et accessoires pour réaliser des créations artistiques à l'infini.
Strass, paillettes, peintures, stickers : Peggy Sage vous offre une large sélection de décors d'ongles
pour des manucures tendances.

A complete range of decorations and accessories for endless ways to indulge your creativity!
Rhinestones, glitters, paints, stickers: Peggy Sage offers an extensive selection of nail decorations
for trendy manicures.

STRASS POUR ONGLES / RHINESTONES FOR NAILS

STRASS* POUR ONGLES RHINESTONES* FOR NAILS

Taille réelle strass
Rhinstone real size

SS3	Ø 1,50 mm	
SS5	Ø 1,90 mm	
SS10	Ø 2,80 mm	

SS3 x 100

SS5 x 20

SS5 x 100

SS10 x 20



148180

SS3 argent x 100



148181

SS3 aurore boréale x 100



148000

SS5 multicolore x 20



148005

SS5 argent x 20



148028

SS5 aurore boréale x 20



148014

SS5 blush rose x 20



148173

SS5 crystal rose gold x 20



148015

SS5 scarabée x 20



148174

SS5 light silk x 20



148191

SS5 argent x 100



148194

SS5 aurore boréale x 100



148016

SS5 scarlet x 20



148011

SS5 majestic blue x 20



148012

SS5 white opal x 20



148182

SS10 argent x 20



148183

SS10 aurore boréale x 20

NEW



148039

carré argent x 28
2 mm



148040

triangle argent x 20
3 mm



148041

navette argent x 20
4 x 2 mm

STRASS* POUR ONGLES RHINESTONES* FOR NAILS

*Crystals from Swarovski®

NEW

DÉCORS D'ONGLES CRISTAL CRYSTAL NAIL DECORATIONS



148240
angel



148241
glam



148242
silver



148243
smoke



KIT 5 BOÎTIERS À VIS
KIT OF 5 EMPTY SCREW STACK JARS
149493 - 8x3 cm - livrés vides / supplied empty

BOÎTE NAIL ART 12 COMPARTIMENTS
12-COMPARTMENT NAIL ART BOX
155345 - 8x5x1,5cm - livrée vide / supplied empty



NAIL ART BOX
 Boîte de 12 compartiments à vis.
 Box of 12 stacked screw-top compartments.
149497 - 12x9x1,7 cm - livrée vide / supplied empty

PIC À STRASS
RHINESTONE PICK-UP TOOL
148199 - x5



PINCE NAIL ART COURBÉE
 Permet de prélever et d'appliquer très facilement strass et décors d'ongles.
CURVED NAIL ART TWEEZERS
 For picking up and applying rhinestones and nail decorations very easily.
149292

PINCE NAIL ART
 Un instrument de haute précision très fin et pointu pour saisir décors adhésifs, strass, paillettes... en un tour de mains.

NAIL ART TWEEZERS
 A very fine, pointed high-precision instrument for picking up decorative stickers, rhinestones, glitter, etc. in a trice.
149293



POCHOIRS NAIL ART DUO
DUO NAIL ART STENCILS
898160

VERNIS NAIL ART

Des couleurs franches et un pinceau très fin pour créer les décors les plus minutieux

NAIL LACQUER NAIL ART

Pure colours and a very fine brush to create very finely detailed decorations.
7 ml



149456
lux goddess



149460
noir



149461
blanc



149476
pailleté argent

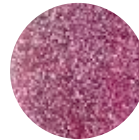

149471
fuchsia métallisé



149470
argent métallisé

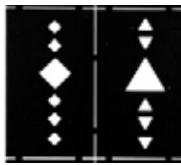

898161

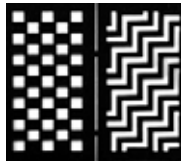

898164

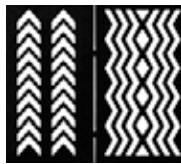

898162

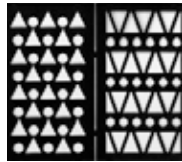

898165

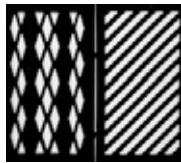

898163

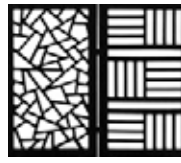

898166

**POCHOIRS ADHÉSIFS POUR ONGLES
ADHESIVE NAIL STENCILS**



**CARROUSEL DÉCORS POUR ONGLES
CAROUSEL FOR NAIL DECORATIONS**

fruits & flowers - **149920** - 600 pcs / stk



149910
jewels x 600

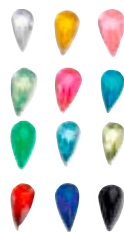

149912
drops x 600

**CARROUSEL DÉCORS POUR ONGLES
CAROUSEL FOR NAIL DECORATIONS**

jewels - **149910** - 600 pcs

drops - **149912** - 600 pcs

| PAILLETES POUR ONGLES / NAIL GLITTERS



149542 - silver



149543 - pearl

PAILLETES POUR ONGLES

Format économique. Très pratique grâce à son embout fin pour une diffusion précise des paillettes.

NAIL GLITTERS

Economy pack. Comes with a very practical fine tip for precise placing of glitter.
tube de paillettes / Tube of glitter 6 g

GLITTER MIX

Un kit de 10 couleurs de paillettes à assortir sans aucune limite !
Kit of 10 glitter colours to mix and match to your heart's desire!



149580 - fiesta

149581 - fluo



COLLE PAILLETES POUR ONGLES

GLITTER GLUE FOR NAILS

149600 - 4 ml

PINCEAU POUR DÉCORS PAILLETÉS

BRUSH FOR SPARKLING DECORATIONS

149550

**PAILLETTES POUR ONGLES
NAIL GLITTERS**



148346
graffiti



148347
girly



148348
kawaii



148349
candy



148360
starlight



148361
silver shimmer



148362
silver mix



149776
metallic fuchsia



149777
metallic sand



149778
metallic red

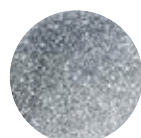

149501
argent



149506
or



149507
blanc



149570
neon coral



149929
red

**GLITTER FLAKES POUR ONGLES
NAIL GLITTER FLAKES**

149929

**DÉCORS POUR ONGLES - MINI BALLS
NAIL DECORATIONS - MINI BALLS**



149356
silver - 3 g



149357
gold - 3 g



149358
black - 3 g



149359
rose gold - 3 g



149310 - or

149311 - argent

**MINI KIT PAILLETTES POUR ONGLES
NAIL GLITTER MINI KIT**

149310 - or

149311 - argent



149312 - or



149313 - argent

MINI KIT NAIL ART NAIL ART MINI KIT

149312 - or
149313 - argent

DÉCORS ADHÉSIFS POUR ONGLES

Mix & match et donnez du relief à votre manucure !
Perlés ou métalliques, les décors adhésifs Peggy Sage accompagneront toutes vos envies de nail art !

DECORATIVE NAIL STICKERS

Mix and match these decorations to bring your manicure alive! Peggy Sage pearl and metallic decorative stickers are the perfect accompaniment to all kinds of nail art creations!

148273 - metallic studs



148273
x 25

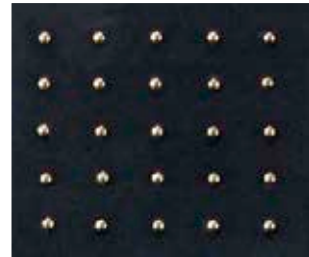

148250
argent x 48

DÉCORS D'ONGLES CRISTAL CRYSTAL NAIL DECORATIONS

148250 - ø 2 mm - argent - sachet de 48 pièces / bag of 48 pcs

FEUILLES MÉTALLISÉES POUR ONGLES METALLISED SHEETS FOR NAILS

149137 - or



149137 - or



149108 - argent



149109 - or



149117 - noir

DÉCORS ADHÉSIFS POUR ONGLES DECORATIVE NAIL STICKERS

149108 - argent
149109 - or
149117 - noir



PIGMENTS NAIL ART EFFET CHROME

Réaliser de sublimes effets miroir ! Sur gel UV ou vernis semi-permanent de couleur nous vous recommandons le noir pour un effet chrome particulièrement intense catalysé et dégraissé, saupoudrer de pigments la surface de l'ongle puis brosser vigoureusement à l'aide d'un applicateur mousse maquillage (voir page 230). Appliquer ensuite votre finition et catalyser.

CHROME-EFFECT PIGMENTS

Create stunning mirror effects on your own and your clients' nails!

First, apply a coloured UV gel or semi-permanent nail lacquer (we recommend black for a particularly intense chrome effect), then catalyze and degrease.

Next, sprinkle the pigments onto the nail surface and rub them in vigorously with a foam make-up applicator (p. 230). Finally, apply your finish and catalyze.



149953
gold - 1 g



149954
mirror - 1 g



149955
holo - 0,5 g



149923
white pearl - 1 g



149924
rose gold - 0,25 g



149925
aurora - 0,25 g

BASE COAT POUR ONGLES SPÉCIAL EFFET CHROME CHROME-EFFECT BASE COAT FOR NAILS

100990 - 11 ml



TOP COAT POUR ONGLES SPÉCIAL EFFET CHROME CHROME-EFFECT TOP COAT FOR NAILS

100991 - 11 ml





| TRANSFER FOILS



149711 - gold



149712 - silver



149713 - fuchsia



149714 - black



TRANSFER FOIL NAIL ART
NAIL ART TRANSFER FOIL

COLLE SPÉCIALE TRANSFER FOILS
TRANSFER FOIL GLUE
149716 - 8ml





| PAINT MANIA 2.0

NEW



148940
blanc



148941
noir



148942
marron



148943
vert



148944
bleu

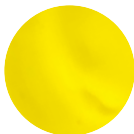

148945
jaune



148946
rouge



148947
orange



PEINTURE NAIL ART PAINT MANIA 2.0

Spécifiquement conçues pour le nail art !

Les peintures Paint mania de Peggy Sage ont une texture unique, à la fois fluide et riche en pigments afin de vous permettre d'exprimer pleinement votre créativité ! Révéler votre âme d'artiste, mélanger les teintes afin d'obtenir des nuances subtiles et de réaliser tous les motifs de votre choix.

À utiliser uniquement sur ongles artificiels. Ne pas appliquer sur ongles naturels.

PAINT MANIA NAIL ART PAINT 2.0

Designed especially for nail art!

Peggy Sage Paint mania paints have a unique texture that is both fluid and rich in pigments that enables you to express your creativity to the full! Bring out the artist inside you: mix colours to produce subtle shades and create any pattern you like. For use on artificial nails only. Do not apply to natural nails.

12 ml

PALETTE D'ARTISTE
Une palette pour mélanger les couleurs et obtenir toutes les nuances de peinture que vous souhaitez.

ARTIST'S PALETTE
A palette for mixing colours to create any shade of paint you want.

155332 - 22x17 cm



PALETTE NAIL ART

Parfaite pour toutes vos réalisations nail art grâce à ses petits emplacements pour vos strass, paillettes, bijoux et décors... et un espace central pour mélanger vernis et peintures nail.

NAIL ART PALETTE

Perfect for all your nail art creations because it has little places to put rhinestones, glitter, jewels, decorations, etc., plus a central area for mixing nail art lacquers and paints.

155334 - 16,5 x 10,5 x 1,3 cm

GODET ANTI-VERSE
Couvercle amovible pour faire tremper les pinceaux et encoches pour les reposer.

NON-SPILL POT
Removable cover for soaking brushes and notches in which to place them.

155333 - H 9 cm, ø 7,5 cm





| STAMPING



VERNIS À ONGLES STAMPING

Vernis à ongles stamping.

STAMP NAIL LACQUER

Stamp nail lacquer.

11 ml



11 ml



100960
noir



100961
blanc

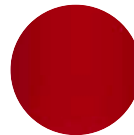

100962
rouge



100963
silver



100964
gold

KIT STAMPING RACLOIR & TAMPON 2.0

Inséparables : le racloir fait pénétrer le vernis à ongles à l'intérieur du motif de la plaque de stamping et permet de retirer tout surplus pour des décors parfaits et sans bavure, et le tampon de transférer facilement le motif sélectionné de la plaque à l'ongle.

SCRAPER & STAMP NAIL-STAMPING KIT

These two tools work together: the scraper ensures the nail lacquer fills the stamping plate design properly and removes the surplus for perfect, smudge-free nail decorations; the stamp has two silicone ends that make transferring the design from plate to nail child's play.

898259

PLAQUE DE STAMPING NAIL ART

À utiliser avec le kit 898259. Appliquer une couche de vernis Peggy Sage sur le motif désiré de la plaque, puis passer la raclette afin de bien faire pénétrer le vernis à l'intérieur du motif et retirer le surplus de vernis. Prélever le motif à l'aide du tampon puis l'appliquer sur l'ongle. Finaliser par une couche de top coat.

NAIL ART STAMPING PLATE

For use with kit 898259. Apply a coat of Peggy Sage nail lacquer to your chosen plate design and then scrape over the top of it with the scraper to ensure the lacquer fills the design properly and to remove the surplus. Pick up the design with the stamp and apply it to the nail. Finish off with a coat of top coat.



898261

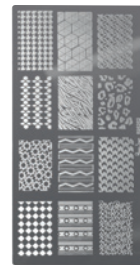

898262



898263



898264



898265



898267



898268



898269



898271



898270



898272



898273

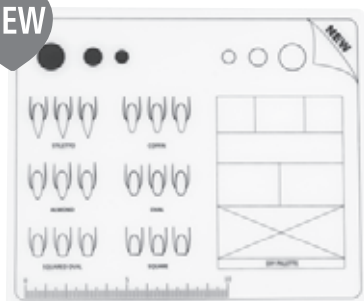

898299

SET NAIL ART CREATIVE WORKSHOP

Set de table nail art en silicone pour protéger votre plan de travail, tester vos couleurs de vernis, semi-permanents, gel UV..., vos créations nail art : mélange de couleurs, reverse stamping...

Vous pourrez facilement transférer votre réalisation directement sur votre ongle. Magique ! Antidérapant, souple et lavable.

CREATIVE WORKSHOP NAIL ART TAFELONDERLEGGER

Silicone nail art table mat to protect your work surface and try out different lacquer, semi-permanent lacquer and UV gel colours, nail art creations, etc., for colour mixing, reverse stamping, and more.

You can then easily transfer your creations directly onto each nail. Magic! Non-slip, soft and washable.

898270 - 30 x 40cm

898299 - 15 x 18cm

| DÉCORS POUR ONGLES / DECORATIVE NAIL STICKERS

DÉCORS ADHÉSIFS POUR ONGLES
DECORATIVE NAIL STICKERS

WATER DECALS

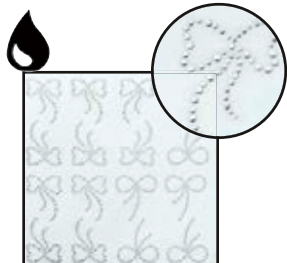

149682



149230



149231



149232



149242

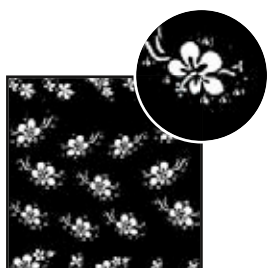

149796



149244



149245



149247



149238

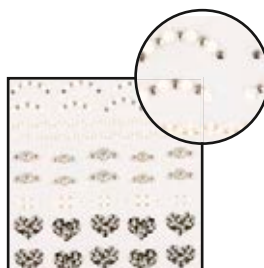

149239



149240

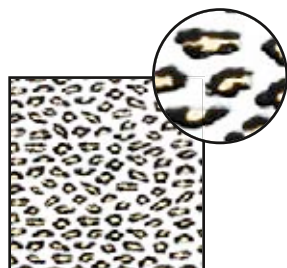

149837

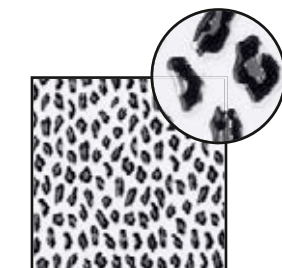

149838

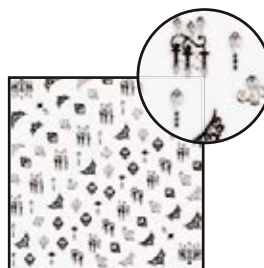

149885



149849

DÉCORS ADHÉSIFS POUR ONGLES
DECORATIVE NAIL STICKERS

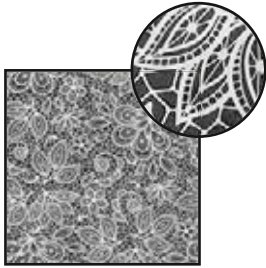

149650



149651

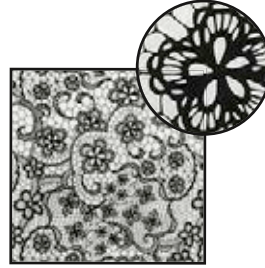

149653

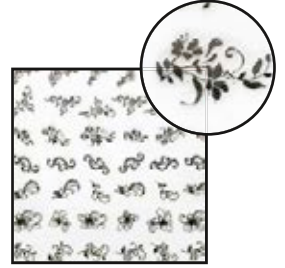

149858

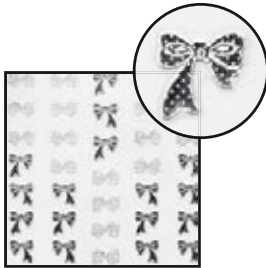

149880

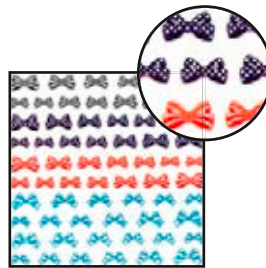

149881



149048

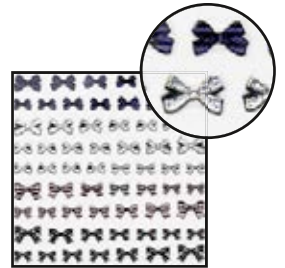

149879

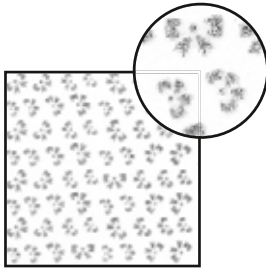

149058

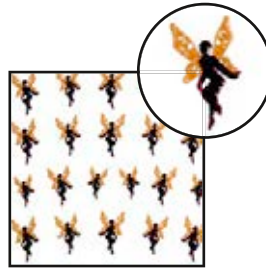

149846



149082

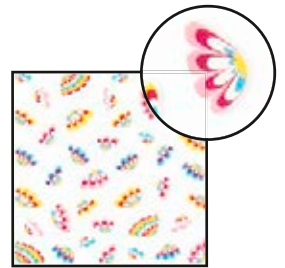

149882



149049



149647



149898



149899

DÉCORS ADHÉSIFS POUR ONGLES
DECORATIVE NAIL STICKERS

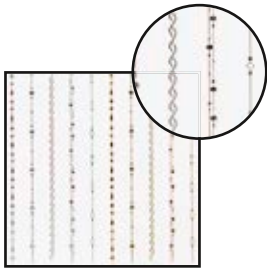

149216



149217

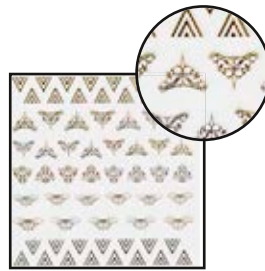

149218



149219

DÉCORS ADHÉSIFS POUR ONGLES
DECORATIVE NAIL STICKERS

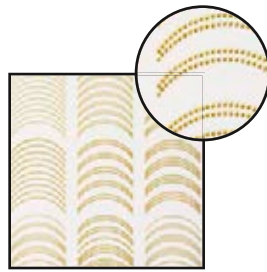

149717

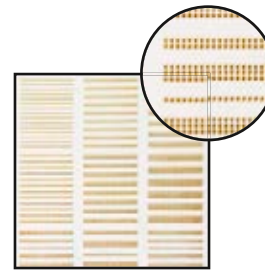

149718

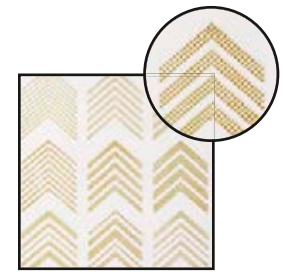

149719

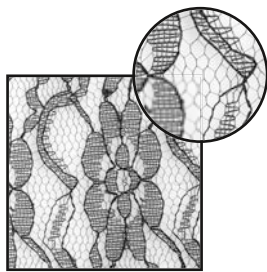

149366
dentelle

DÉCORS POUR ONGLES
DECORATIVE NAIL STICKERS

DÉCORS ADHÉSIFS POUR ONGLES
DECORATIVE NAIL STICKERS

 Kids



149273



149274



149275





O N G L E S / N A I L S

FORMES ET CAPSULES / FORMS & TIPS

Réaliser des constructions et extensions des ongles aisément grâce aux formes et capsules professionnelles.
Apporter du relief et de la longueur à vos ongles et à ceux de vos clients efficacement.

Travailler avec nos produits de qualités pour des résultats de haute précision.

Create nail constructions and extensions the easy way with our professional forms and tips.

The effective way to add relief and length to your nails and your clients' nails.

Work with our quality products for high-precision results.

| FORMES / FORMS

FORMES

Les formes Peggy Sage sont suffisamment flexibles pour s'adapter à la taille de tout doigt tout en garantissant un maintien précis. Leur matériau garantit une répartition uniforme de la chaleur du corps pour une polymérisation parfaitement répartie.

FORMS

Peggy Sage forms are flexible enough to fit fingers of any size while guaranteeing precise hold. Made of a material that guarantees uniform distribution of body heat for perfectly even polymerization.

140004 - x500

140005 - x50



140004 - x500



140005 - x50

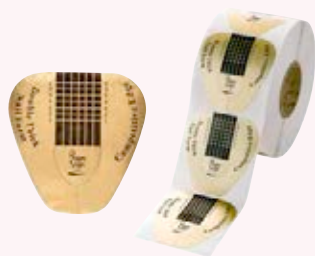

FORMES DOUBLE ÉPAISSEUR DOUBLE THICKNESS FORMS

140033 - x500

FORMES FER À CHEVAL HORSE SHOE FORMS

140030 - x500
PM / klein

140031 - x500
MM / medium

140032 - x500
GM / groot



140030 - x500



140031 - x500



140032 - x500



NEW



FORMES ADHÉSIVES POUR ONGLES PAPILLON

Les formes Papillon sont idéales pour le rallongement des ongles, que soit en gel ou en résine.

BUTTERFLY ADHESIVE NAIL FORMS

These Butterfly forms are perfect for both gel and acrylic resin nail extensions.

140035 - x500



NEW



**FORMES ADHÉSIVES POUR ONGLES
ADHESIVE NAIL FORMS
140045 - x 500**

**FORMES ADHÉSIVES POUR ONGLES
ADHESIVE NAIL FORMS
140044 - x 500**



FORMES TRANSPARENTES
Idéales pour le façonnage des faux ongles. Convient particulièrement pour faciliter la polymérisation sous lampe UV des gels les plus opaques et pigmentés.
TRANSPARENT FORMS
Ideal for artificial nail construction. Particularly suitable for making polymerization of the most opaque and heavily pigmented gels under a UV lamp easier.
140042 - x 500

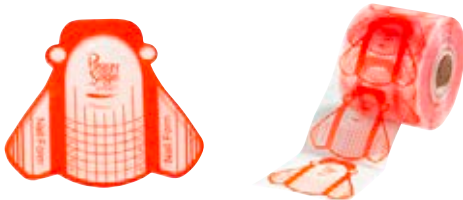

**FORMES POUR ONGLES
NAIL FORMS
140040 - x 500 - large / wide**



5 FORMES RÉUTILISABLES
Pour les adeptes de cette technique, les formes réutilisables fournissent un support stable et adaptable à chaque taille de doigt pour la construction des faux ongles.
5 REUSABLE FORMS
For those who like to use this technique, reusable forms provide a stable and adaptable support for nails of any size when constructing artificial nails.
140008 - x5



PINCE MÉTAL À RECOURBER LES FORMES POUR ONGLES
Outil idéal pour vous aider à bien fixer les bords des formes pour ongles ainsi que les bords des capsules lors du collage.
METAL PLIERS FOR CURVING NAIL FORMS
The ideal tool to help you to stick down nail form and tip edges properly when applying them.
143013





| CAPSULES NATURELLES PROFESSIONAL TIPS

NATURELLES / NATURAL

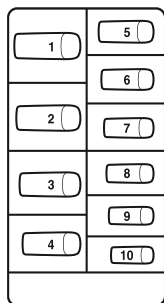

UNIVERSELLES CARRÉES

Bande de collage large. Pour des ongles soignés et raffinés.

UNIVERSAL SQUARE TIPS

Wide gluing strip. For elegant, well groomed nails.

142410 - x 50
10 tailles / 10 sizes

142600 - x 100
10 tailles / 10 sizes

142400 - x 250
10 tailles / 10 sizes

142399 - x 500 : 10 tailles / 10 sizes

142451 - 50 n°1

142452 - 50 n°2

142453 - 50 n°3

142454 - 50 n°4

142455 - 50 n°5

142456 - 50 n°6

142457 - 50 n°7

142458 - 50 n°8

142459 - 50 n°9

142460 - 50 n°10

1	5
	6
2	7
	8
3	9
	10
4	

NEW



POINTE FINE

Bande de collage courte. Facilitent le façonnage. Pour des ongles en amande, gracieux et sophistiqués.

FINE-POINTED

Wide gluing strip. Easy to shape and time-saving. For creating all types of nail shape. For fine, delicate-looking nails.

142433 - x50
10 tailles / 10 sizes

142633 - x100
10 tailles / 10 sizes

142443 - x250
10 tailles / 10 sizes

CARRÉES SPEED
Bande de collage courte. Facilitent le façonnage.
Pour des ongles soignés et raffinés.

SPEED SQUARE

Short gluing strip. For easy sculpting
For elegant, well groomed nails.

142418 - x50
10 tailles / 10 sizes

142606 - x100
10 tailles / 10 sizes

142406 - x250
10 tailles / 10 sizes



1	5
	6
2	7
	8
3	9
	10
4	

1	5
	6
2	7
	8
3	9
	10
4	



POINTE FINE

Bande de collage courte. Facilitent le façonnage.
Pour des ongles en amande, gracieux et sophistiqués.

FINE-POINTED

Short gluing strip. For easy sculpting.
For graceful and sophisticated almond-shaped nails.

142411 - x50
10 tailles / 10 sizes

142601 - x100
10 tailles / 10 sizes

142401 - x250
10 tailles / 10 sizes

BOMBÉES
Bande de collage large.
Redonnent un bombé naturel aux ongles.

CURVED

Wide gluing strip.
Restore the nails' natural curve.

142412 - x50
10 tailles / 10 sizes

142602 - x100
10 tailles / 10 sizes

142402 - x250
10 tailles / 10 sizes



1	5
	6
2	7
	8
3	9
	10
4	

TRANSPARENTES / CLEAR

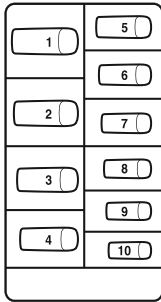

UNIVERSELLES CARRÉES

Bande de collage courte. Spéciales « nail art ».
Facilitent le façonnage.

UNIVERSAL SQUARE

Short gluing strip. Designed for "Nail art".
For easy sculpting.

142415 - x 50
10 tailles / 10 sizes

142605 - x 100
10 tailles / 10 sizes

142405 - x 250
10 tailles / 10 sizes

STILETTO

Sans bande de collage. Facilitent le façonnage.
Idéales pour les décors les plus inventifs.
Without any gluing strip for ultra-fast sculpting.
Ideal for the most inventive decorations.

142428 - x 50 : 10 tailles / 10 sizes

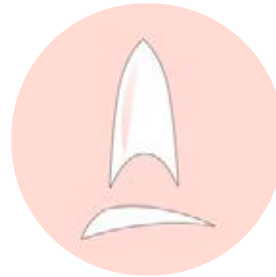

FRENCH

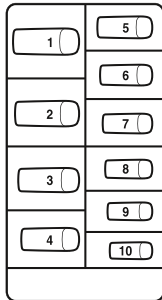

FRENCH CARRÉES

Bande de collage courte.
Facilitent le façonnage.

FRENCH SQUARE

Short gluing strip. For easy sculpting.

142413 - x 50
10 tailles / 10 sizes

142603 - x 100
10 tailles / 10 sizes

142403 - x 250
10 tailles / 10 sizes

FROSTED CLEAR

UNIVERSELLES CARRÉES

Bande de collage large. Pour des ongles soignés et raffinés.

UNIVERSAL SQUARE

Wide gluing strip. For elegant, well groomed nails.

142700 - x 50 : 10 tailles / 10 sizes





142431
natural



142432
clear

CAPSULES LONG STILETTO TIPS LONG STILETTO

142431 - natural x 50

142432 - clear x 50

CAPSULES PROFESSIONNELLES NAIL ART EXTRA-LONGUES

Capsules pointues extra-longues pour réaliser les décorations nail art les plus artistiques et extravagantes lors de compétitions et démonstrations.

EXTRA-LONG PROFESSIONAL NAIL ART TIPS

Extra-long pointed tips for creating the most artistic and extravagant nail art decorations for competitions and demonstrations.

142790 - x 24 : 12 tailles / 12 maten



142050

142051



CAPSULES PROFESSIONNELLES

Capsules moules pour gel sculpt et résine. Appliquer la matière directement à l'intérieur de la capsule pour une forme parfaite et la longueur que vous souhaitez. Catalyser (gel sculpt) ou laissez sécher (résine) puis décollez la capsule.

PROFESSIONAL TIPS

Tip moulds for Gel Sculpt and acrylic resin. Apply the material directly to the inside of the tip to create the perfect shape in the length you want. Catalyze (Gel Sculpt) or leave it to dry (acrylic resin) and then remove the tip.

QUICK FORMS

142050 - x 100 - 10 tailles / 10 size



POP IT

142051 - x 100 - 10 tailles / 10 size - avec graduation / with gradation

TIP SOFTEN +

Ramollisseur de capsules pour un limage très rapide. Permet de fondre plus facilement la démarcation entre la capsule et l'ongle naturel. Softens tips for extremely fast filing. Makes it easier to blend in the line between the tip and the natural nail.

146007 - 15 ml



**PINCE GUILLOTINE POUR CAPSULES
GUILLOTINE CLIPPERS FOR TIPS**
143011



6 g

COLLE ROSE

Restitue le rose naturel de l'ongle notamment avec les capsules transparentes ou French.

PINK GLUE

Restores the nails' natural pink colour when used with transparent or French tips.

146048 - 6 g - avec pinceau / with brush

**COLLE TRANSPARENTE
POUR CAPSULES ET PANSEMENTS
CLEAR GLUE FOR TIPS AND WRAPS**

146040 - 3g

146039 - 10x3g

146041 - 14,17g



3g

10 x 3g

14,17g

146042 - 6g
avec pinceau / with brush

146049 - 14,17g
avec pinceau / with brush



6g

14,17g



NAIL ART DIAMOND

Apporter une touche de luxe à vos créations nail art : ce joli accessoire en forme de diamant vous permet de réaliser ou présenter tous vos Nail Art. Présentoir en verre en forme de diamant avec un support aimanté pour vos capsules.

Add a touch of luxury to your nail art creations! This attractive diamond-shaped accessory is for creating or showcasing all your nail art designs. A diamond-shaped glass display stand with magnetic tip holder.

142515

| KITS FAUX ONGLES / ARTIFICIAL NAILS SETS



SET FAUX ONGLES

Spécial grand public. Contient 20 capsules naturelles ovales (8 tailles), 1 colle et 1 lime.

SET ARTIFICIAL NAILS

For retail use. Contains 20 natural oval tips (8 sizes), 1 glue and 1 file.

150050

SET FAUX ONGLES

Jolie forme ovale très naturelle. À vernir et customiser au gré de vos envies et créations nail art pour un résultat pro et longue tenue. Colle professionnelle 3g incluse.

SET ARTIFICIAL NAILS

Attractive and very natural-looking oval shape. Lacquer and customize them any way you want and use them for nail art creations for long-lasting, professional results. 3g professional glue included.

150051 - x200 : 10 tailles / 10 sizes



MINI KIT CAPSULES PROFESSIONNELLES UNIVERSELLES CARRÉES

Contient 20 capsules (10 tailles), 1 colle (146040), 1 ponce bloc blanc (122210) et 1 mode d'emploi.

UNIVERSAL SQUARE PROFESSIONAL TIPS MINI KIT

Contains 20 tips (10 sizes), 1 glue (146040), 1 white sanding block (122210) and 1 instruction sheet.

150005 - 10x4,4x17,2 cm



SET 100 FAUX ONGLES

Mode d'emploi : déposer la colle dans la capsule. Appliquer celle-ci sur l'ongle. La maintenir 10s pour qu'elle adhère. Contient 100 capsules.

100 ARTIFICIAL NAILS SET

Way of use: place the glue into the tip. Apply it on the nail. Keep it 10s to the glue to dry. 100 natural oval tips.

10 tailles / 10 sizes



150048
Natural



150049
Nude pink





KIT 24 FAUX ONGLES IDYLIC NAILS

Idéales quelle que soit l'occasion, pour un look original et raffiné en un clin d'œil !
 Application facile et rapide pour tout type d'ongles.
 Colle 2 g de qualité professionnelle incluse !

KIT OF 24 IDYLIC NAILS ARTIFICIAL NAILS

These tips, specially designed to make your hands look more beautiful, come ready coloured and featuring nail art patterns or a French manicure design on them. All you have to do is put them on! Easy and quick to apply to all types of nails. 2 g professional-quality glue included!

12 tailles / 12 sizes



150071
French - fine



150072
French - large



150075
red



150077
fuchsia



150078
corail



150079
plum



150080
pink



150081
shiny French



150084
shiny flower



150087
silver French



150054
baby pink



150055
rose wood



150076
black



150056
French stiletto



150057
baby boomer



150058
coral stiletto



150059
pink stiletto



150052
smart oval



150053
stiletto chic

| DÉPOSE I-LAK, 1-LAK & RÉSINE I-LAK, 1-LAK & ACRYL REMOVAL



140116

PINCES POUR LA DÉPOSE D'I-LAK, 1-LAK ET DE LA RÉSINE

Imbiber une compresse manucure 155420 (ou un disque coton 170000) avec la solution de fonte tips off 146033, la plier en 2 puis l'appliquer sur l'ongle, positionner ensuite la pince sur le doigt. Laisser poser 10 à 15 minutes.

5 PEGS FOR USE IN I-LAK AND ACRYLIC RESIN REMOVAL

Soak a manicure wipe 155420 (or cotton wool disc 170000) with tips off solvent 146033, fold it in half and place it on the nail, then apply a peg to the finger. Leave it on for 10 to 15 minutes.

140116 - x5

140117 - x5
spéciales pieds / For toes.



140117

NAIL SOAKERS

Pour la dépose des faux ongles en I-LAK, 1-LAK et résine.
For removing soak off gel and acrylic resin artificial nails.

140115 - x10



120 COMPRESSES AUTO-AGRIPPANTES

Pour la dépose des faux ongles en résine, I-LAK et 1-LAK.

120 SELF-ADHESIVE SOAKING PADS

For removing soak off gel and acrylic resin artificial nails.

155482 - boîte de 120 compresses / box of 120 soaking pads

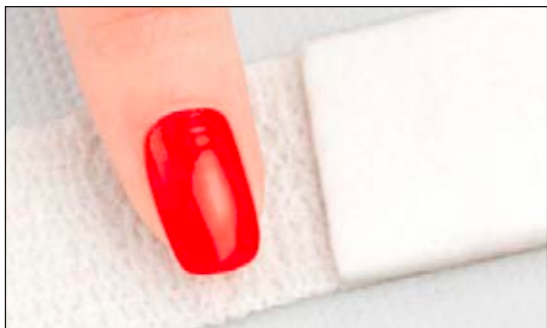

FEUILLES ALUMINIUM AVEC COMPRESSE INTÉGRÉE
 Pour la dépose des faux ongles en résine et gel.
ALUMINIUM FOIL SHEETS WITH INTEGRAL SOAKING PADS
 For removing gel and acrylic resin artificial nails.

155484
 boîte de 50 feuilles
 box of 50 foil sheets

155481
 boîte de 100 feuilles
 box of 50 foil sheets

155483
 boîte de 250 feuilles
 box of 50 foil sheets



PLATEAUX TREMPAGE POUR ONGLES
NAIL SOAKING TRAYS
140114 - x2

TIPS OFF
 Solution pour dissoudre I-LAK, 1-LAK, les capsules et la résine. Enrichie en huile
 d'amande douce nourrissante.

Solution for dissolving I-LAK, 1-LAK, tips and acrylic. Enriched with nourishing
 sweet almond oil.

146003 - 115 ml

146033 - 485 ml

146004 - 950 ml





ONGLES / NAILS

ACCESSOIRES / ACCESSORIES

Les matériels qui accompagnent tous les professionnels de l'ongle pour des prestations irréprochables. Lampes, ponceuses, limes, etc. Retrouver toutes les innovations de Peggy Sage pour un matériel de pointe afin de répondre aux techniques les plus exigeantes.

The equipment every nail professional needs for faultless results.

Lamps, electric nail files, manual files and more... A host of Peggy Sage innovations in the latest equipment, enabling you to master even the most demanding techniques.

Roubloff

for Peggy Sage

PINCEAU NAIL ART KOLINSKY ROUBLOFF FOR PEGGY SAGE

Poil naturel Kolinski. Grâce à sa forme en pétale, ce pinceau permet de réaliser des designs avec précision en gel.

ROUBLOFF KOLINSKY NAIL ART BRUSH

Natural kolinsky bristles. With its petal-shaped tip, this brush is suitable for precision gel design work.

141064 - GK93R - taille / size 3

NEW



NEW

PINCEAU NAIL ART ROUBLOFF FOR PEGGY SAGE

Poil synthétique, imitation Kolinski. Pinceau liner pour réaliser de longues et fines lignes. Travail de précision pour les plus petits détails.

ROUBLOFF NAIL ART BRUSH

Synthetic bristles, imitation kolinsky. Liner brush for painting long, fine lines. For precision work to create the smallest details.

141065 - DS43R - taille / size 10/0



PINCEAU NAIL ART ULTRA FIN ROUBLOFF FOR PEGGY SAGE

Pinceau liner de détail très haute qualité professionnelle. Idéal pour dessiner arabesques, spirales et traits ultras fins. Pointe longue et précise, il vous permet de travailler vos nail arts avec finesse.

ULTRA-FINE SYNTHETIC NAIL ART BRUSH ROUBLOFF FOR PEGGY SAGE

Professional-quality detail liner brush. Perfect for painting arabesques, spirals and very fine lines. With its long, precision tip, use this brush for detailed nail art work.

141069 - DK43R 5/0 - synthétique/synthetic



PINCEAU NAIL ART ÉVENTAIL KOLINSKY ROUBLOFF FOR PEGGY SAGE

Poil naturel Kolinsky. Idéal pour travailler paillettes, pigments et dégradés 1-stroke un résultat ultra qualitatif.

FAN NAIL ART KOLINSKY BRUSH ROUBLOFF FOR PEGGY SAGE

Ideal for working with glitters, pigments and gradations using the 1-stroke technique, for ultra-professional results.

141057 - DK73R-00 - taille 00 / size 00



PINCEAUX NAIL ART / NAIL ART BRUSHES

Roubloff
for Peggy Sage



LINER NAIL ART KOLINSKY ROUBLOFF FOR PEGGY SAGE

Poil naturel Kolinsky. Pointe longue, précise et fine idéale pour le travail d'arabesques et de marbrures.

NAIL ART LINER KOLINSKY BRUSH ROUBLOFF FOR PEGGY SAGE

Natural kolinsky sable-hair bristles. Its long, accurate and fine tip makes this brush ideal for creating arabesques and marbling.

141059 - DK43R-00 - taille 00 / size 00

PINCEAU NAIL ART EXTRA FIN KOLINSKY ROUBLOFF FOR PEGGY SAGE

Poil naturel Kolinsky. Pinceau extra fin qui permet de réaliser un travail de détail avec une vraie finesse et une réelle précision.

EXTRA-FINE NAIL ART KOLINSKY BRUSH ROUBLOFF FOR PEGGY SAGE

Natural kolinsky sable-hair bristles. This extra-fine brush enables you to carry out fine-detail work with amazing delicacy and precision.

141058 - DK13R-00 - taille 00 / size 00



SET 6 PINCEAUX NAIL ART SET OF 6 NAIL ART BRUSHES **141060**

PINCEAU NAIL ART ROSE GOLD

Très fin pour réaliser vos plus beaux nail art.

ROSE GOLD ACRYLIC RESIN BRUSH

A very fine tip for creating intricate nail art designs.

141032 - taille 001 / maat 001



PINCEAU NAIL ART

Pour aller encore plus loin dans la création de vos décors.

NAIL ART BRUSH

Achieve even better results when decorating nails.

141021 - MM



141028 - extra-fin / extra-fine

141029 - ultra-précis / extra-fine detail



141061 - éventail / fan

141062 - fin standard / standard fine



141063 - liner

141027 - set 3 pinceaux nail art / set of 3 nail art brushes



**PINCEAU NAIL ART CRYSTAL
CRYSTAL NAIL ART BRUSH**

141073

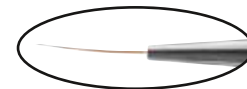

**DUO PINCEAU NAIL ART / OUTIL À MARBRER CRYSTAL
CRYSTAL NAIL ART BRUSH / MARBLING TOOL DUO
141075**

PINCEAUX NAIL ART / NAIL ART BRUSHES

PINCEAUX 1-STROKE

8 pinceaux professionnels spécialement conçus pour la peinture nail art et particulièrement adaptés aux techniques 1-stroke, micro peinture et aquarelle (ajout d'eau).

1-STROKE BRUSHES

8 professional brushes designed especially for nail art painting and particularly suitable for the 1-stroke, micro-painting and watercolour painting techniques (with water).

Permet de réaliser des touches fines ou épaisses.
For adding thin or thick touches.

141040 - 1-stroke liner



Permet de réaliser de petits détails pour un travail de haute précision.
For adding little details for high-precision work.

141041 - 1-stroke biseauté / tapered 1-stroke brush



Adapté à la plupart des motifs (petits à moyens).
Suitable for most designs (small to medium-sized).

141042 - 1-stroke plat PM / flat 1-stroke brush S

Adapté à la plupart des motifs (moyens à grands).
Suitable for most designs (medium-sized to large).

141043 - 1-stroke plat GM / flat 1-stroke brush L



Idéal pour les détails ultrafins et les finitions à l'aquarelle.
Ideal for ultra-fine details and watercolour finishes.

141044 - 1-stroke aquarelle / 1-stroke & watercolour brush

Idéal pour réaliser des dégradés de couleurs.
Ideal for shading in different colours.

141045 - 1-stroke biseauté PM / tapered 1-stroke brush S



Pinceau de détail taille 00
Size 00 detail brush.

141046 - 1-stroke 00

Pinceau de détail taille 0
Size 0 detail brush

141047 - 1-stroke 0



PINCEAUX GEL UV / UV GEL BRUSHES



**PINCEAU SPECIAL GEL UV
SPECIAL UV GEL BRUSH**

141000 - taille 4 / size 4



141001 - taille 6 / size 6



141019 - taille 11 / size 11

141023 - pinceau biseauté GM / large tapered brush



141024 - pinceau biseauté PM / small tapered brush

141025 - pinceau plat GM / large flat brush



141026 - pinceau plat PM / small flat brush

141070 - taille 4 / size 4 strass



141071 - taille 6 / size 6 strass



PINCEAUX GEL UV / UV GEL BRUSHES

Roubloff
for Peggy Sage



PINCEAU GEL DESIGN ROUBLOFF FOR PEGGY SAGE

Poil synthétique. Permet une excellente application et un travail d'une extrême précision. Peut-être utilisé pour façonner tout type de gels, idéal pour des décors en gels 2D ou 3D.

STYLISH GEL BRUSH BY ROUBLOFF FOR PEGGY SAGE

Synthetic bristles. For extremely even application and high-precision work. Can be used to shape all types of gel, ideal for 2D and 3D gel nail decorations.

141087 - GN93R-4 - taille 4 / size 4

PINCEAU GEL UV ROUBLOFF FOR PEGGY SAGE

Poil synthétique. Idéal pour une application et une répartition parfaite du gel UV, notamment des gels de couleur. Permet un tracé net des contours en un tour de mains.

UV GEL BRUSH ROUBLOFF FOR PEGGY SAGE

Synthetic bristles. Ideal for faultless application and spreading of UV gels, particularly coloured gels. Perfect for neat edging in a trice!

141083 - GC33R-6 - taille 6 / size 6



PINCEAU GEL DESIGN BISEAUTÉ ROUBLOFF FOR PEGGY SAGE

Poil synthétique. Pinceau très effilé qui rend le travail de la construction très facile et le travail du bombé net et précis.

STYLISH TAPERED GEL BRUSH ROUBLOFF FOR PEGGY SAGE

Synthetic bristles. An extremely slender brush that makes nail construction oh so easy and ensures the curve of the nail is neat and accurate.

141085 - GN63R-4 - taille 4 / size 4

PINCEAU PLAT GEL DESIGN ROUBLOFF FOR PEGGY SAGE

Poil synthétique. Pinceau plat petit modèle : permet de travailler avec une extrême précision sur des ongles courts et étroits (base, couleur, finition).

STYLISH FLAT GEL BRUSH ROUBLOFF FOR PEGGY SAGE

Synthetic bristles. This small, flat-tipped brush is just right for working with painstaking precision on short and narrow nails (base, colour and finish).

141086 - GN33R-4 - taille 4 / size 4



PINCEAU PLAT GEL UV ROSE GOLD
ROSE GOLD FLAT-TIPPED UV GEL BRUSH

Idéal pour l'application du gel UV.

Perfect for applying UV gel.

141033 - taille 4 / size 4

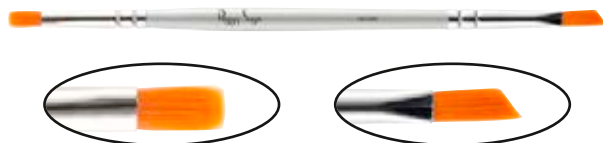

PINCEAU 2-EN-1 SPÉCIAL GEL UV
2-IN-1 UV GEL BRUSH

141090 - taille 4 biseauté / size 4 tapered

PINCEAU GEL UV POINTE HIGH TECH
Pour appliquer le gel, dessiner la French et réaliser des décors nail art. Pointe en caoutchouc, facile d'utilisation et d'entretien.

BRUSH FOR UV GEL WITH HIGH-TECH TIP

For applying gel, painting the French manicure smile line and creating nail art decorations. Rubber tip, easy to use and clean.

141080 - plat / flat

141081 - nail art



141080



141081



PINCEAU STRASS NAIL ART EN SILICONE
SILICONE NAIL ART BRUSH WITH RHINESTONES

141076

OUTIL LISSE-GEL

Permet de réaliser un bombé parfait et des décors fins et précis lors de vos poses de gel. Acier inoxydable.

GEL SMOOTHING TOOL

For creating a perfect curve and neat, delicate decorations when applying gel. Stainless steel.

149555



PINCEAUX RÉSINE / SPECIAL ACRYLIC BRUSHES



STRIPER SPÉCIAL MOTIFS ET DÉCORS D'ONGLES
STRIPER BRUSH FOR NAIL PATTERNS AND DECORATIONS
141002

LE GRAND KOLINSKY
141003 - poil de martre / sable hair



GOLDEN OVAL
141004 - spécial acrylique / special acrylic

GOLDEN EDGE
141006 - spécial acrylique / special acrylic



PINCEAU POUR PRIMER
BRUSH FOR PRIMER
141009

GOLDEN FLAT
141010 - PM / small



THE BEST KOLINSKY
141013 - poil de martre / sable hair

NAIL ART SPÉCIAL ACRYLIQUE
SPECIAL ACRYLIC NAIL ART
141020



PINCEAU RÉSINE ROUBLOFF KOLINSKY FOR PEGGY SAGE

Poil naturel Kolinsky. Sa pointe fine et sa forme en pétale permettent un façonnage d'excellente qualité et la réalisation de détails et motifs 3D en toute précision.

**ROUBLOFF FOR PEGGY SAGE
ACRYLIC RESIN KOLINSKY BRUSH**

Natural kolinsky sable-hair bristles. Its fine tip and petal shape make this the ultimate brush for top-quality shaping and creating details and 3D designs in minute detail. It is easy and comfortable to hold thanks to its longer handle, for greater control and dexterity.

141012 - AK93R-4 - taille 4 / size 4



PINCEAU RÉSINE ROSE GOLD KOLINSKY

Forme ovale pour travailler au mieux la résine.

ROSE GOLD ACRYLIC RESIN BRUSH - KOLINSKY

Oval to work the acrylic resin at best.

141034 - taille 8 / size 8

**PINCEAU OUTIL À MARBRER 2-EN-1
2-IN-1 BRUSH / MARBLING TOOL**

149553

pinceau plat / flat brush

149554

pinceau nail art / nail art brush



149553



149554



149551

**OUTIL À MARBRER
MARBLING TOOL**

149551

149556 - PM / S



149556



**INSTRUMENT DÉGRADÉ ET BABY BOOMER
COLOUR GRADIENT AND BABY BOOMER MANICURE TOOL
141077**

**EMBOUTS MOUSSE DE RECHANGE X 4 PIÈCES
POUR INSTRUMENT 141077
SPARE FOAM TIPS X 4 FOR INSTRUMENT 141077
141079**

NEW



149558

**OUTIL À MARBRER
MARBLING TOOL
149558 - Ø: 1,5 mm / 2,5 mm**

**OUTIL À MARBRER / PIC À STRASS
MARBLING TOOL / RHINESTONE PICK-UP TOOL
141078**



141078



149552

**OUTIL À MARBRER DESIGN
STYLISH MARBLING TOOL
149552**



**BAC DE NETTOYAGE POUR PINCEAUX
BRUSH CLEANING TUB
140113**

**NETTOYANT PINCEAUX RÉSINE
ACRYLIC BRUSH CLEANER**
141008 - 60ml



60 ml



TROUSSE POUR PINCEAUX ONGLES ET MAKE-UP

Craquer pour notre jolie trousse rose gold dédiée au rangement de vos pinceaux et accessoires !

BRUSH BAG

You'll love this pretty Rose Gold bag for storing your brushes and accessories!

141096 - 5 x 17 cm (ouverte/open) - 26 x 17 cm (fermée/closed)
livrée vide / supplied empty

MALLETTE DE RANGEMENT POUR PINCEAUX

Cette mallette de rangement pratique et élégante vous permet de ranger tous vos pinceaux et d'organiser votre plan de travail. Retrouver facilement vos pinceaux grâce aux 10 emplacements intégrés. Cette mallette est votre alliée parfaite pour tous vos déplacements ou vos prestations à domicile.

BRUSH CASE

This practical, elegant brush case is just the job for storing all your brushes and organising your work surface. The 10 integrated brush holders make it easy to find the brush you need. This brush case is very handy when you're on the move or providing home-based beauty services.

200560 - 24,5 cm x 9,5 cm x 4,5 cm - livrée vide / supplied empty

NEW



ACCESSOIRES ET PETIT MATÉRIEL ACCESSORIES & SMALL EQUIPMENT



PROTÈGE-CUTICULES ADHÉSIF

Idéals pour les water marble et les dégradés... et les débutantes ! Appliquer un protège-cuticule adhésif de taille adaptée sur le contour de votre ongle, sa matière souple épouse parfaitement la forme de l'ongle. Vous pouvez commencer immédiatement votre pose de vernis ou votre création nail art. Lorsque votre vernis est bien sec, retirez délicatement l'adhésif.

PEEL-OFF CUTICLE GUARDS

Ideal for water marbling, colour gradations and beginners! Select a peel-off cuticle guard of the right size and apply it to the nail edge. The soft material will mould to fit the nail shape exactly. You can begin applying lacquer or creating your nail art design straight away. Once the lacquer is thoroughly dry, carefully peel off the guard.

140025 - x10

MINI BÂTONNETS MANUCURE MINI MANICURE STICKS

120206 - x10



BÂTONNETS MANUCURE MANICURE STICKS

120006 - x8

RUBAN AUTO-AGRIPPANT

Protège les doigts de la professionnelle pendant le limage des ongles de la cliente.

SELF ADHESIVE STRIP

Protects the technician's fingers when filing the client's nails.

155460 - blanc
largeur / width 5 cm

155462 - beige
largeur / width 2,5 cm

155463 - rouge
largeur / width 2,5 cm



BOÎTE DE 100 CAPSULES
Coffret de rangement pour 100 capsules (10 compartiments).

BOX FOR 100 TIPS
Storage for 100 tips (10 compartments).

151200 - livrée vide / Isupplied empty



141100

141101

BROSSE À ONGLES

Permet un nettoyage parfait des ongles et de leur pourtour.

SMALL NAIL BRUSH

For making nails and surrounding areas perfectly clean.

141100 - small

141101 - design

GODET VERRE

GLASS CUP

146050



TRIPLE GODET PLASTIQUE

Spécial poudre et liquide de façonnage.

TRIPLE PLASTIC CUP

Designed for sculpting powder and liquid.

140100

PIPETTE PLASTIQUE
Pour transférer le liquide et/ou la poudre de façonnage dans le godet.

PLASTIC PIPETTE

For transferring sculpting liquid and/or powder into the cup.

140106 - x5





x 80

80 ÉPONGES SPÉCIALES NAIL ART ET DÉMAQUILLAGE DES ONGLES

Parfaites pour réaliser des dégradés en vernis à ongles et peinture Paint Mania. Non tissées. Idéales également pour dégraisser ou démaquiller les ongles.

80 NAIL ART AND NAIL MAKE-UP REMOVER SPONGES

Perfect for shading in different colours of nail lacquer and Paint Mania paint. Nonwoven. Also ideal for degreasing nails and removing nail make-up.

155413 - x 80

ÉPONGES POUR DÉGRADÉS NAIL ART

Mini éponges parfaitement adaptées à la taille des ongles et idéales pour réaliser des dégradés en vernis à ongles, I-LAK et gels de couleur Peggy Sage.

10 SPONGES FOR NAIL ART COLOUR GRADUATIONS

Triangular mini-sponges perfect for use on nails and ideal for creating colour graduations with Peggy Sage nail lacquers, I-LAK and coloured gels.

155414 - x 10

155415 - x 5 - avec applicateur / with applicator



155414 x 10

155415 x 5



141051

141052

PINCEAU ANTI-POUSSIÈRE

Poils synthétiques de haute qualité et ultra-doux. Idéal pour retirer les poussières de limage lors du façonnage des faux ongles.

DUST BRUSH

High-quality ultra-soft synthetic bristles. Ideal for removing filing dust when sculpting artificial nails.

141051

141052 - GM / big

BROSSE ULTRA-DOUCE ANTI-POUSSIÈRE ULTRA-SOFT DUSTING BRUSH

141053



BOL MANUCURE DESIGN
STYLISH MANICURE BOWL
146060 - 17,5 cm x 13,5 cm x 4,8 cm



BOL MANUCURIE FROIDE

Le couvercle se retire pour un nettoyage facile et rapide.

COLD MANICURE BOWL

The cover comes off for easy, fast cleaning.

146054 - 6,5 cm x Ø 12,5 cm

POMPE MENDA POUR DISSOLVANT
MENDA PUMP FOR NAIL LACQUER REMOVER
140012 - 240 ml - livrée vide / supplied empty



POMPE AVEC DISTRIBUTEUR

Hermétique pour éviter l'évaporation de vos cleaners et dissolvants.
Une pression suffit pour imbiber un coton !

PUMP WITH DISTRIBUTOR

Hermetically sealed to prevent your cleaners and solvents from evaporating!
One press is enough to soak a cotton wool pad!

140015 - 200 ml - livrée vide / supplied empty

ACCESSOIRES ÉLECTRIQUES ELECTRIC ACCESSORIES



LAMPE UV CLASSIC

Lampe UV avec interrupteur et minuteur 2 positions 120 sec / continu. Contient 4 néons de 9 W. Garantie sur le matériel électrique : 2 ans.

CLASSIC 36W UV LAMP

UV lamp with switch + timer (120 sec.). Contains 4 9W neon bulbs. Warranty on electrical equipment: 2 years.

144052 - 25 x 17 x 12 cm - 36 W - 220-240 V 50 Hz
néon de rechange : 144037 / spare neon bulb: 144037

LAMPE UV ADVANCED

Lampe UV avec interrupteur + minuteur bi-fonction (1, 2 ou 3 min / continu). Contient 4 néons de 9 W. La base de la lampe se retire facilement pour remplacer les néons et nettoyer l'intérieur de la lampe. La taille de la lampe permet de traiter aussi bien une main qu'un pied. Garantie sur le matériel électrique : 2 ans.

LAMPE UV 36 W ADVANCED

UV lamp with switch + dual-action timer (1, 2 or 3 minutes / constant). Contains 4 9W neon bulbs. Lamp base can be easily removed for replacing bulbs and cleaning the lamp interior. This lamp is large enough to treat a foot as well as a hand. Warranty on electrical equipment: 2 years.

144047 - 28 x 22 x 11 cm - 36 W - 220-240 V 50 Hz
néon de rechange : 144037 / spare neon bulb: 144037



144037

NÉON DE RECHANGE

SPARE NEON BULB

144037 - 9 W
Longueur / Length: 135 mm
pour lampes UV / for UV lamps
144047, 144052

144038 - 9 W
Longueur / Length: 141 mm
pour lampes UV / for UV lamps
144047, 144052



144038



30 FEUILLES DE PROTECTION ALUMINIUM POUR LAMPE UV

Protègent la base des lampes UV et assurent une hygiène irréprochable à chaque cliente.

30 PROTECTIVE ALUMINIUM SHEETS FOR UV LAMPS

Protect the base of UV lamps and ensure faultless hygiene for each client.

144091 - 14,5 x 14,5 cm - pour lampes UV / for UV lamps 144047, 144052

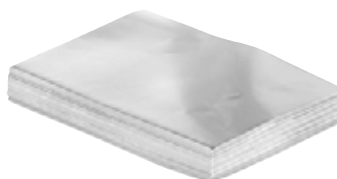

PAIRE DE GANTS DE PROTECTION ANTI-UV MANUCURE SPF 30

Protège la peau de la cliente du rayonnement ultraviolet lors de l'utilisation de votre lampe UV Peggy Sage.

PAIR OF ANTI-UV PROTECTIVE MANICURE GLOVES SPF 30

Protects the client's skin from ultraviolet radiation when using your Peggy Sage UV lamp.

170097 - taille unique - lavable en machine 40°C / one size fits all - machine washable at 40°C

LAMPE LED HYBRID TECHNOLOGY ONYX MATT

Lampe 12 LED x 1 W avec bouton timer 30 s. Compacte et performante, idéale pour catalyser votre vernis semi-permanent I-LAK. Garantie sur le matériel électrique : 2 ans.

LED LAMP HYBRID TECHNOLOGY ONYX MATT

12 x 1 W LED lamp with 30s timer button. This compact, powerful lamp is perfect for catalyzing I-LAK semi-permanent nail lacquers. Warranty on electrical equipment: 2 years.

144078 - 12 W - 12 x 9,5 x 6 cm



NEW



LAMPE LED HYBRID TECHNOLOGY

Innovation technologique hybride : catalyse l'intégralité des gels UV et/ou LED Peggy Sage. Bouton ON/OFF, timer 15s/30s/60s/120s. Déclenchement automatique. Spacieuse pour une utilisation optimale manucure et pédicure, forme ergonomique afin de parfaitement catalyser les 5 doigts de la main. Garantie sur le matériel électrique : 2 ans.

LED LAMP HYBRID TECHNOLOGY

This innovative hybrid technology catalyzes any Peggy Sage UV and/or LED gel. ON/OFF button, 15s/30s/60s/120s timer. Auto-on feature. A spacious lamp perfect for both manicures and pedicures. Its ergonomic shape enables all 5 fingers on the hand to be catalyzed together in comfort. Warranty on electrical equipment: 2 years.

144089 - 45 W - 36 LED x 1,25 W - 20 x 20 x 8 cm

2 paires de lunettes de protection / 2 pairs of safety glasses

LAMPE LED PRO HYBRID TECHNOLOGY

Lampe 12 LED x 3W. Innovation technologique hybride: catalyse l'intégralité des gels UV et/ou LED Peggy Sage. Timer 10s/30s/60s. Affichage LCD. Fonction sèche-verniss + LED rouge pour l'éclat et la jeunesse de la peau - timer 5 minutes.

Spacieuse pour une utilisation optimale manucure et pédicure, forme ergonomique afin de parfaitement catalyser les 5 doigts de la main.

Garantie sur le matériel électrique : 2 ans.

PRO LED LAMP, HYBRID TECHNOLOGY

12 x 3W LED lamp. This innovative hybrid technology catalyzes any Peggy Sage UV and/or LED gel. 10s/30s/60s timer with gradual power increase function for the 60s timer to prevent any feeling of overheating for maximum comfort. LCD display. Nail lacquer dryer + red LED to boost the skin's radiance and youthfulness - 5-minute timer. A spacious lamp perfect for both manicures and pedicures. Its ergonomic shape enables all 5 fingers on the hand to be catalyzed together in comfort. Warranty on electrical equipment: 2 years.

144087 - 36 W - 21,5 x 19,5 x 8,8 cm



NEW



LAMPE LED HYBRID TECHNOLOGY PINK ANGEL

Innovation technologique hybride: catalyse l'intégralité des gels UV et/ou LED Peggy Sage. Bouton ON/OFF, timer 30s/60s/90s. Spacieuse pour une utilisation optimale manucure et pédicure, forme ergonomique afin de parfaitement catalyser les 5 doigts de la main. Garantie sur le matériel électrique : 2 ans.

LED LAMP HYBRID TECHNOLOGY PINK ANGEL

This innovative hybrid technology catalyzes any Peggy Sage UV and/or LED gel! ON/OFF button, 30s/60s/90s timer. A spacious lamp perfect for both manicures and pedicures. Its ergonomic shape enables all 5 fingers on the hand to be catalyzed together in comfort. Warranty on electrical equipment: 2 years.

144092 - 36 W - 20 x 19 x 9,4 cm



PONCEUSE POUR ONGLES PEGGY TOUCH

Ponceuse au design attractif, très facile d'utilisation, idéale pour les débutants et les particuliers. Contient 1 ponceuse, 6 embouts, 1 mandrin et 3 émeris. Fonctionne avec 2 piles LR3 1,5 V non fournies. 8000 tr/min. Garantie sur le matériel électrique : 2 ans.

PEGGY TOUCH ELECTRIC NAIL FILE

Attractively designed electric nail file that is very easy to use and ideal for beginners and individuals. Contains 1 electric nail file, 6 bits, 1 mandrel and 3 sanding bands. Operates with 2 x LR3 1.5V batteries, not supplied. 8000 rpm. Warranty on electrical equipment: 2 years.

142976 - 16,3 x 3,3 cm - 120 g

PONCEUSE POUR ONGLES QUICK START

Ponceuse professionnelle idéale pour démarrer une activité de prothésiste ongulaire. Utilisation manucure et pédicure. Set de 8 embouts professionnels 142901 inclus. Garantie sur le matériel électrique : 2 ans.

ELECTRIC NAIL FILE QUICK START

The ideal professional electric nail file for those starting out as nail technicians. For manicures and pedicures. Set of 8 professional bits 142901 included. Warranty on electrical equipment: 2 years.

142974 - 220-240V – 50Hz



PONCEUSE POUR ONGLES PEGGY STYLE

Ponceuse professionnelle pour exercer manucure, pédicure et prothèse ongulaire. Stylet micromoteur ergonomique. Système de fixation rapide des embouts. Réglage du sens de rotation : gauche/droite. Set de 8 embouts professionnels 142901 inclus. Support de maintien du stylo. Vitesse de rotation : réglage progressif jusqu'à 20 000 tr/min. Garantie sur le matériel électrique : 2 ans.

PEGGY STYLE ELECTRIC NAIL FILE

Professional electric nail file for manicures, pedicures and artificial nail construction. Ergonomic micromotor handpiece. Fast-action bit attachment system. Rotation setting: clockwise/anticlockwise. Set of 8 professional bits 142901 included. Handpiece stand. Rotation speed: continuously adjustable up to 20.000 rpm.

Warranty on electrical equipment: 2 years.

142975 - 230V 50/60 Hz - stylet / handpiece: 140 g - 14 x Ø 2,5 cm
boîtier de commande / control unit: 700 g - 8,5 x 12 x H 6,5 cm



PONCEUSE POUR ONGLES HIGH PERFORMANCE

Légère et compacte ! La performance entre vos mains pour pratiquer manucurie, pédicurie et prothèse ongulaire. Stylet ergonomique. Réglage progressif jusqu'à 35.000 tr/min. Réglage du sens de rotation droitier / gauche. Système de fixation rapide des embouts. Support de maintien du stylet. Set de 8 embouts professionnels 142901 inclus. Pédale marche - arrêt.
Garantie sur le matériel électrique : 2 ans.

HIGH PERFORMANCE ELECTRIC NAIL FILE

Light and compact! Performance at your fingertips for manicures, pedicures and artificial nail construction. Ergonomic handpiece. Continuously adjustable up to 30.000 rpm. Adjustable rotation direction. Fast-action bit attachment system. Handpiece storage ring. Set of 8 professional bits included (142901).
On/off foot pedal.

Warranty on electrical equipment: 2 years.

142905 - 220V 50/60Hz - stylet / handpiece: 214 g - 15,3 x Ø 2,8 cm
boîtier de commande / control unit: 1,23 kg - 15,6 x 11,8 x 7,8 cm



PONCEUSE TOUCH OF STYLE

Cette ponceuse Touch of style permet d'exercer votre activité partout grâce à sa batterie, et se recharge directement grâce à son cordon secteur. Temps de charge de la batterie : environ 2h30. Temps d'utilisation de la batterie : environ 8 heures avec régime maximum et sans charge intermédiaire. Elle convient parfaitement pour une activité à domicile ou avec déplacements réguliers.
Garantie sur le matériel électrique : 2 ans.

TOUCH OF STYLE ELECTRIC NAIL FILE

With the Touch of Style electric nail file, you can be professional and trendy at the same time. Featuring the very latest technology, it includes a handpiece and digital readout. With its compact, elegant and futuristic design with clean lines, this electric nail file will make a discreet addition to your workspace.
Warranty on electrical equipment: 2 years.

142966 - 220V 50/60Hz - 0-30000 tr/mn / rpm - stylet / handpiece : 194 g - 12,5 cm
boîtier de commande / control unit : 358 g - 14 x 6,8 x 3,8 cm

PONCEUSE EASY LIFE

Cette ponceuse Easy Life permet d'exercer votre activité de façon professionnelle tout en suivant la tendance. Définitivement high tech, elle est équipée d'un stylet et d'un écran numérique. Retrouver un design compact, élégant et futuriste avec cette ponceuse épurée qui s'intégrera discrètement dans votre espace de travail.
Garantie sur le matériel électrique : 2 ans.

EASY LIFE ELECTRIC NAIL FILE

With the Easy Life electric nail file, you can be professional and trendy at the same time. Featuring the very latest technology, it includes a handpiece and digital readout. With its compact, elegant and futuristic design with clean lines, this electric nail file will make a discreet addition to your workspace.
Warranty on electrical equipment: 2 years.

142965 - 220V 50/60Hz - 0-30000 tr/mn / rpm - stylet / handpiece : 148 g - 12 cm
boîtier de commande / control unit : 440 g - 11 x 10,8 x 8 cm



EMBOUTS DE PONCEUSE ELECTRIC NAIL FILE BITS

NEW



EMBOUT FINITION FAUX ONGLES

Embout professionnel : utiliser l'embout sur la surface des ongles en résine ou gel pour corriger la ligne du sourire.

ARTIFICIAL NAILS FINISHING BIT

Professional bit: use this bit to correct the smile line on the surface of acrylic or gel nails.

143107 - x2

EMBOUT MANUCURE SURFACE DE L'ONGLE

Utiliser l'embout pour éliminer les cuticules.

NAIL SURFACE MANICURE BIT

Professional bit: use this bit to remove cuticles.

143109 - x2



EMBOUT SURFACE FAUX ONGLES

Utiliser l'embout sur la surface des ongles en résine ou gel.

ARTIFICIAL NAILS SURFACE BIT

Professional bit: use this bit on the surface of acrylic or gel nails.

143103 - x2



EMBOUT FINITION DESSOUS FAUX ONGLES

Utiliser l'embout sous le dessous des ongles en résine ou gel pour éliminer les résidus de colle ou de matière. Permet également de nettoyer l'ongle naturel lors de la repousse.

ARTIFICIAL NAILS UNDERSIDE FINISHING BIT

Professional bit: use this bit to remove excess glue and material from the underside of acrylic or gel nails. It can also be used to clean natural nail that has grown.

143106 - x2



EMBOUT PÉDICURE GRANDES SURFACES

Utiliser l'embout pour éliminer les rugosités et peaux mortes sous le pied. Peut également être utilisé sur le dessus des orteils pour soulager les cors.

LARGE AREAS PEDICURE BIT

Professional bit: use this bit to remove rough areas and dead skin from underneath the foot. Can also be used on top of the toes to relieve corns.

143104 - x2



ÉMERI GRAIN FIN (240)

Utiliser l'émeri pour travailler la surface de l'ongle.

FINE-GRIT SANDING BAND (240)

This sanding band is for smoothing the surface of the nail.

142992 - x12

143020 - x24

142995 - x50

143023 - x100

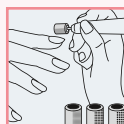
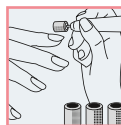

ÉMERI GRAIN MOYEN (150)

Utiliser l'émeri pour travailler la surface de l'ongle (idéal pour le gel).

MEDIUM-GRIT SANDING BAND (150)

This sanding band is for smoothing the surface of the nail (ideal for gel).

142993 - x12

143021 - x24

142996 - x50

143024 - x100

ÉMERI GROS GRAIN (80)

Utiliser l'émeri pour travailler la surface de l'ongle (idéal pour la résine).

COARSE-GRIT SANDING BAND (80)

This sanding band is for smoothing the surface of the nail (ideal for acrylic).

142994 - x12

143022 - x24

142997 - x50

143025 - x100

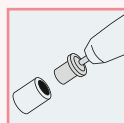
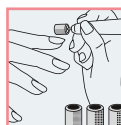

MANDRIN POUR ÉMERI

Utiliser l'embout en adaptant l'émeri correspondant en fonction du travail.

SANDING BAND MANDREL

Attach the appropriate sanding band for the use required.

143190 - x2

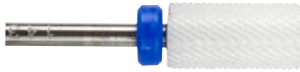

EMBOUT CÉRAMIQUE SURFACE FAUX ONGLES GEL UV

Embout professionnel esthétique et résistant. Grain moyen. Utiliser l'embout pour affiner les contours et éliminer les résidus de gel UV.

CERAMIC SURFACE BIT FOR ARTIFICIAL NAILS – UV GEL

Attractive and hardwearing professional bit. Medium grit. This bit is for refining the nail edges and removing UV gel residue.

143308

EMBOUT CÉRAMIQUE SURFACE FAUX ONGLES RÉSINE

Embout professionnel esthétique et résistant. Grain très dur. Utiliser l'embout pour affiner les contours.

CERAMIC SURFACE BIT FOR ARTIFICIAL NAILS ACRYLIC RESIN

Attractive and hardwearing professional bit. Very coarse grit. This bit is for refining the nail edges.

143309



EMBOUT CÉRAMIQUE SURFACE FAUX ONGLES GEL ET RÉSINE

Embout professionnel esthétique et résistant. Grain dur. Utiliser l'embout pour affiner les contours et éliminer les résidus de gel UV.

CERAMIC SURFACE BIT FOR ARTIFICIAL NAILS – UV GEL AND ACRYLIC RESIN

Attractive and hardwearing professional bit. Coarse grit. This bit is for refining the nail edges and removing UV gel residue.

143310

EMBOUT CÉRAMIQUE PRÉCISION FAUX ONGLES

Embout professionnel esthétique et résistant. Grain moyen. Ultra précis pour affiner les contours et nettoyer le dessous des ongles.

CERAMIC PRECISION BIT FOR ARTIFICIAL NAILS

Attractive and hardwearing professional bit. Medium grit. An ultra-precision bit for refining the nail edges and cleaning the underside of the nail.

143311



EMBOUT CÉRAMIQUE CONTOURS FAUX ONGLES

Embout professionnel esthétique et résistant. Grain dur. Utiliser l'embout pour affiner les contours, réaliser les finitions, nettoyer le dessous des ongles et éliminer les résidus de gel, résine ou colle.

CERAMIC EDGING BIT FOR ARTIFICIAL NAILS

Attractive and hardwearing professional bit. Coarse grit. This bit is for refining the nail edges, finishing, cleaning the underside of the nail and removing gel, acrylic resin or glue residue.

143307



EMBOUT CONTOURS FAUX ONGLES - EXTRA-FIN

Embout professionnel : technicien averti. Grain fin. Utiliser l'embout pour affiner les contours, réaliser les finitions, nettoyer le dessous des ongles et éliminer les résidus de gel, résine ou colle.

ARTIFICIAL NAILS EDGING BIT - EXTRA-FINE

Professional bit for experienced technicians. Fine grit. Use this bit for refining the nail edges, finishing, cleaning the underside of the nail and removing gel, acrylic resin or glue residue.

143305



EMBOUT FINITION DESSOUS FAUX ONGLES SÉCURITÉ +

Embout professionnel : technicien averti. Grain fin. Extrémité sans denture et sans risque. Utiliser l'embout pour nettoyer le dessous des ongles et éliminer les résidus de gel, résine ou colle.

ARTIFICIAL NAILS UNDERSIDE FINISHING BIT - SAFETY PLUS

Professional bit for experienced technicians. Fine grit. Risk-free bit with no cutting surface on the tip. Use this bit for cleaning the underside of the nail and removing gel, acrylic resin or glue residue.

143306



EMBOUT PRÉCISION FAUX ONGLES

Embout professionnel : longue durée, revêtement spécifique anti-échauffement. Utiliser l'embout pour travailler la surface de l'ongle.

PRECISION BIT FOR ARTIFICIAL NAILS

Professional bit: long duration, specific anti-heating coating. Use this bit to smooth the surface of the nail.

142989

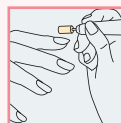

EMBOUT PRÉPARATION FAUX ONGLES

Embout professionnel : longue durée, revêtement spécifique anti-échauffement. Utiliser l'embout pour affiner les contours.

PREPARATION BIT FOR ARTIFICIAL NAILS

Professional bit: long duration, specific anti-heating coating. Use this bit to refine the nail edges.

142988



EMBOUT DE PRÉPARATION FAUX ONGLES SÉCURITÉ +

Embout professionnel : technicien averti. Grain fin. Grande précision. Extrémité sans denture et sans risque. Utiliser l'embout pour affiner les contours.

ARTIFICIAL NAILS PREPARATION BIT - SAFETY PLUS

Professional bit for experienced technicians. Fine grit. High precision. Risk-free bit with no cutting surface on the tip. Use this bit for refining the nail edges.

143304





EMBOUET FAÇONNAGE SURFACE FAUX ONGLES

Embout professionnel. Grain moyen. Utiliser l'embout pour le travail de construction et de façonnage sur la surface des ongles en résine ou en gel.

SHAPING BIT NAIL EXTENSIONS SURFACE

Professional bit. Medium grit. Use this bit for building and shaping on the surface of acrylic resin and gel nails.

143300

EMBOUET FINITION SURFACE FAUX ONGLES

Embout professionnel. Grain fin. Utiliser l'embout pour effectuer des finitions précises sur la surface des ongles en résine ou en gel.

FINISHING BIT NAIL EXTENSIONS SURFACE

Professional bit. Fine grit. Use this bit for creating precision finishes on the surface of acrylic resin and gel nails.

143301



BROSSE POUR NETTOYER LES EMOUETS DE PONCEUSE

BRUSH FOR CLEANING ELECTRIC NAIL FILE BITS

143385

SET DE 8 EMOUETS PROFESSIONNELS

Comprend 1 embout pédicure grandes surfaces, 1 embout surface faux ongles, 1 embout petites surfaces faux ongles, 1 embout finition faux ongles, 1 embout finition dessous faux ongles, 1 embout manucure surface de l'ongle, 1 embout feutre et 1 mandrin + 3 émeris (80/150/240).

SET OF 8 PROFESSIONAL BITS

Comprises 1 large areas pedicure bit, 1 nail extensions surface bit, 1 nail extensions bit for small areas, 1 nail extensions finishing bit, 1 nail extensions underside finishing bit, 1 nail surface manicure bit, 1 felt bit, and 1 mandrel + 3 sanding bands (80/150/240).

142901



Instruments pour ponceuse manucure / pédicure High precision
Gamme d'instruments de précision et d'excellence, alliant haute qualité et innovation.
Longue durée. Pour techniciens avertis.

Tools for high-precision manicure/pedicure electric nail file.
A range of superior precision tools that combine high quality with innovation. Long lasting.
For experienced technicians.



INSTRUMENT TITANE SPEED SURFACE FAUX ONGLES

Façonnage de la résine et du gel. Sa forme permet d'épouser celle de l'ongle pour encore plus d'efficacité sans risque. Revêtement anti-échauffement.

SPEED TITANIUM TOOL NAIL EXTENSION SURFACES

Professional bit. For shaping acrylic resin and gel. Its shape is designed to fit close to the nail for superior effectiveness without risk. Heat-reducing coating.

143201 - Ø 60 - M / size M

143200 - Ø 70 - L / size L



143201



143200



INSTRUMENT ABRASIF ONGLES NATURELS ET CUTICULES

Grain très fin pour un ponçage léger et le travail des cuticules.

ABRASIVE TOOL NATURAL NAILS AND CUTICLES

Professional bit. Very fine grit for light sanding and working on the cuticles.

143204

INSTRUMENT POLISSOIR
Pour réaliser toutes les finitions des bords de l'ongle, polissage et lissage.

BUFFER TOOL

Professional bit. For all kinds of finishes to nail edges, buffing and smoothing.

143205



INSTRUMENT ANTI-POUSSIÈRES

Enlève les résidus de poussière d'ongle et de matière, tout particulièrement dans les zones difficiles d'accès comme les cuticules. Poils de chèvre doux.

DUST-REMOVAL TOOL

Professional bit. For cleaning nails and equipment: removes remaining nail dust and material dust, particularly in difficult-to-reach places such as the cuticles. Soft goat hairs.

143206

INSTRUMENT PRÉCISION SPÉCIAL CUTICULES

Spécial ongles naturels. S'utilise avec l'eau émoullente (120001) pour éliminer les petites peaux superflues du contour de l'ongle. Acier inoxydable.

PRECISION TOOL CUTICLES

Professional bit for natural nails. Use with cuticle remover (120001) to remove small pieces of skin around the nail. Stainless steel.

143212



INSTRUMENT DIAMANTÉ PÉDICURE GM

Anti-échauffement. Gros grain. Traitement des rugosités et peaux mortes. Utilisation possible sur peau sèche ou humide.

DIAMOND-COATED PEDICURE TOOL L

Professional heat-reducing bit. Coarse grit. For treating rough skin and dead skin. Can be used on both wet and dry skin.

143210

LIMES À ONGLES / NAIL FILES

Le grain de la lime détermine le degré d'abrasion de l'émeri. Plus le chiffre est petit plus la lime est dure et donc abrasive. Plus le chiffre est grand plus la lime est douce donc non abrasive. Pour les faux ongles, nous recommandons des limes avec un grain plus dur.

Pour les ongles naturels, préférez des limes plus douces.

The grit of the nail file determines how abrasive the emery board is. The smaller the figure, the coarser and more abrasive the nail file. The larger the figure, the finer and less abrasive the nail file. For artificial nails we recommend nail files with a coarser grit. For natural nails it is best to use finer nail files.

LIMES À ONGLES BLANCHES 2 FACES LAVABLES WASHABLE WHITE 2-WAY NAIL FILE



 100 recto
122080

 100 verso / back
122082
lot de 10 pcs
pack of 10 pcs

122081
lot de 30 pcs
pack of 30 pcs

122085

100 recto 
122087
lot de 10 pcs
pack of 10 pcs

180 verso / back 
122086
lot de 30 pcs
pack of 30 pcs



 180 recto
122090

 180 verso / back
122092
lot de 10 pcs
pack of 10 pcs

122091
lot de 30 pcs
pack of 30 pcs

240 recto 

240 verso / back 

122095



 400 recto
122100

 400 verso / back

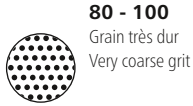

80 - 100
Grain très dur
Very coarse grit

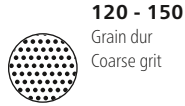

120 - 150
Grain dur
Coarse grit

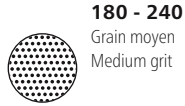

180 - 240
Grain moyen
Medium grit

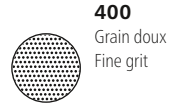

400
Grain doux
Fine grit

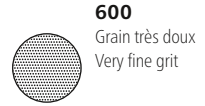

600
Grain très doux
Very fine grit

LIMES À ONGLES NOIRES 2 FACES LAVABLES BLACK WASHABLE 2-WAY NAIL FILES

122950



100 recto
122960
lot de 10 pcs
pack of 10 pcs

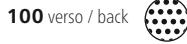

100 verso / back
122970
lot de 30 pcs
pack of 30 pcs



100 recto
122050



180 verso / back
122052
lot de 10 pcs
pack of 10 pcs

122051
lot de 30 pcs
pack of 30 pcs



122955

122957
lot de 10 pcs
pack of 10 pcs



122956
lot de 30 pcs
pack of 30 pcs



240 recto
122980



400 recto



400 verso / back

122990



LIMES À ONGLES 2 FACES LAVABLES WASHABLE 2-WAY NAIL FILE

240 recto 

240 verso / back 

122040 - bleue / blue



 600 recto

 600 verso / back

122030 - rose / pink

LIMES À ONGLES 2 FACES LAVABLES FORME BANANE WASHABLE 2-WAY BANANA NAIL FILE

Leur forme ergonomique permet un limage rapide et précis.
Ergonomic shape for fast, accurate filing.

100 recto 

122503
blanche
white

180 verso / verso 

122513
lot de 10 pcs
pack of 10 pcs



 100 recto

122502
noire
black

 180 verso / verso

122512
lot de 10 pcs
pack of 10 pcs

100 recto 

122500
zebra

180 verso / back 

122510
lot de 10 pcs
pack of 10 pcs

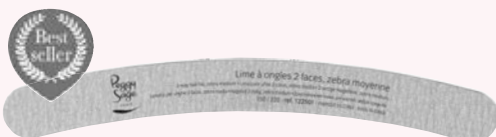
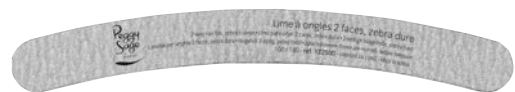

 150 recto

122501 - zebra

 220 verso / back

LIMES À ONGLES 2 FACES LAVABLES COLOSSALES WASHABLE 2-WAY GIANT NAIL FILE



 100 recto
122160

 180 verso / back
122161
lot de 30 pcs / pack of 30 pcs

180 recto 
122170

180 verso / back 
122171
lot de 30 pcs / pack of 30 pcs



 240 recto
122150

 240 verso / back

600 recto 

600 verso / back 
122140



LIMES À ONGLES 2 FACES LAVABLES ÉPAISSES WASHABLE 2-WAY CHUNKY NAIL FILE

Le centre plus épais et souple de ces limes permet un limage très rapide en toute sécurité au plus près de la pulpe des doigts sans jamais blesser comme les bords durs des limes traditionnelles.
With their thicker, softer centre, these nail files can be used for very fast and totally safe filing right next to the finger pads without ever cutting them, as can occur with the edges of standard nail files.

100 recto 

180 verso / back 
122180



 240 recto
122200

 240 verso / back

180 recto 

180 verso / back 
122205



 600 recto
122190

 600 verso / back

LIMES À ONGLES 2 FACES LAVABLES RECTANGULAIRES 2-WAY WASHABLE RECTANGULAR NAIL FILE

Ces limes offrent une surface abrasive plus grande. Idéal pour le façonnage des faux ongles.

These files provide a larger filing surface. Ideal for sculpting artificial nails.



 100 recto
122700

 100 verso / back

100 recto 

180 verso / back 
122701



 180 recto
122702

 180 verso / back

LIME À ONGLES 2 FACES DEMI-LUNE ÉPAISSE 2-WAY CHUNKY HALF-MOON NAIL FILE

Lime épaisse en mousse pour dépolir l'ongle tout en profitant d'un réel confort d'utilisation.

Chunky foam nail file for roughening the nail while being really comfortable to use.

100 recto 

180 verso / back 
122770 - zebra



LIMES À ONGLES 2 FACES LAVABLES DEMI-LUNE WASHABLE 2-WAY HALF-MOON NAIL FILE

Ces limes offrent une plus grande surface abrasive et une meilleure prise en main pour un plus grand confort.
These nail files have a larger filing surface area and are easier to hold for improved comfort.



100 recto

100 verso / back

122750 - blanche / white

100 recto



100 verso / back



122760 - zebra

122765
10 x 122760

122766
30 x 122760



100 recto

180 verso / back

122751 - blanche / white

100 recto



180 verso / back



122761 - zebra

122767
10 x 122761

122768
30 x 122761



180 recto

180 verso / back

122752 - blanche / white

180 recto



180 verso / back



122762 - zebra



LIMES À ONGLES ORIGIN 2 FACES 2-WAY ORIGIN NAIL FILE

180 recto 

240 verso / back 
122673 - fuchsia



 180 recto
122674 - pink

 240 verso / back

180 recto 

240 verso / back 
122675 - purple



MINI LIMES À ONGLES NEON NEON PINK MINI NAIL FILE

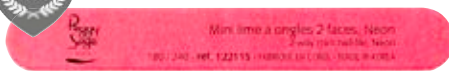

 180 recto
122115 - pink

 240 verso / back

180 recto 

240 verso / back 
122116 - orange



 180 recto
122117 - yellow

 240 verso / back

180 recto 

240 verso / back 
122118 - green

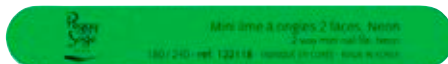

LIMES À ONGLES PROFESSIONNELLES 2 FACES PROFESSIONAL 2-WAY NAIL FILES

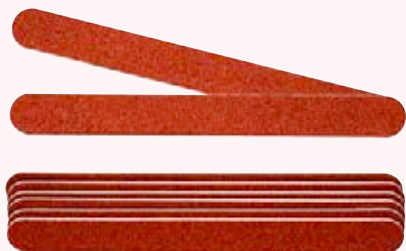

x 8



100 recto



100 verso / back

122230 - marron / brown - lot de 8 pcs / pack of 8 pcs

180 recto



180 verso / back



122240 - noir / black - lot de 8 pcs / pack of 8 pcs



x 8

LIMES À ONGLES PROFESSIONNELLES MANUCURE PROFESSIONAL MANICURE NAIL FILES



x 8



150 recto



180 verso / back

120014 - lot de 8 pcs / pack of 8 pcs

150 recto



180 verso / back



120015 - lot de 36 pcs / pack of 8 pcs

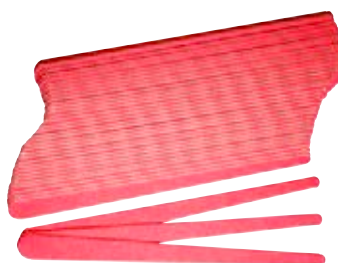

x 36

LIME À ONGLES DIAMANT

Lavable et design. Ultra résistante, elle met délicatement en forme les ongles naturels, même les plus fragiles.

DIAMOND NAIL FILE

Stylish and washable. This ultra-hard-wearing nail file gently shapes even the most fragile natural nails.

122270

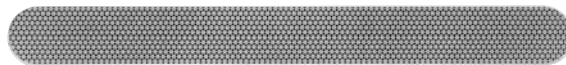

LIME À ONGLES EN VERRE

Spécialement conçue pour les ongles naturels.

GLASS NAIL FILE

Specially designed for natural nails.

122415 - neutre / neutral - lavable / washable

BRILLANCE EXTRÊME 1 MINUTE

Côté vert pour polir et côté blanc pour donner la brillance.

1-MINUTE SUPERSHINE NAIL FILE

Green side for polishing and white side for adding the shine.

122405

Polissoir pour ongles ergonomique
Ergonomic nail buffer

122406

Lime à ongles
2 faces forme demi-lune
Half-moon 2-way nail file

122407

Bloc pour ongles
2 faces
2-way nail block



122405



122406



122407



LIME À ONGLES SUPER BRILLANT 3 FACES

Brillance naturelle immédiate de moyenne à longue durée.

3-WAY SUPERSHINE NAIL FILE

An immediate medium to long-term natural shine.

122410 - 3 faces pour limer, poncer et polir
3 sides for filing, sanding and buffing



122000

POLISSOIR 4 FACES

Lavable. Bleu pour limer, rose pour effacer les rayures, blanc pour lisser, gris pour lustrer.

4-WAY BUFFER

Washable. Blue for filing, pink for removing scratches, white for smoothing and grey for buffing.

122000 - S

122020 - L



122020

PETIT POLISSOIR 3 FACES

Lavable. Grand côté gris pour limer, blanc pour lisser, gris pour lustrer.

3-WAY MINI BUFFER

Washable. Big grey side for filing, white side for smoothing and grey side for buffing.

122010



POLISSOIR DESIGN 4 FACES

Lavable et ergonomique. Bleu pour limer, rose pour effacer les rayures, blanc pour lisser, gris pour lustrer.

STYLISH 4-WAY BUFFER

Washable and ergonomic. Blue for filing, pink for removing scratches, white for smoothing and grey for buffing.

122302

POLISSOIR 4 FACES FLUO

Lavable. Violet pour limer, rose fluo pour effacer les rayures, blanc pour lisser, gris pour lustrer.

FLUORESCENT 4-WAY BUFFER

Washable. Purple for filing, fluorescent pink for removing scratches, white for smoothing and grey for buffing.

122025



LIME PIERRE PONCE

Idéale pour retirer les envies et petites peaux du pourtour de l'ongle.

PUMICE NAIL FILE

Ideal for removing hangnails and small pieces of skin around the nail.

122220

PONCE BLOC ROSE
PINK SANDING NAIL BLOCK
 122219

100 



MINI BLOC PONCE
MINI SANDING BLOCK
 122455

BLOC GOMME 2 FACES
2-WAY EXFOLIATING BLOCK
 122211

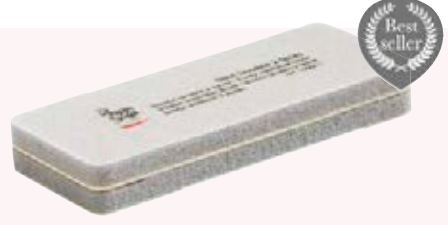

PONCE BLOC BLANC
WHITE SANDING BLOCK
 122210

122209 - x10

 150

PONCE BLOC BLANC SLIM
SLIM WHITE SANDING BLOCK FOR NAILS
 122215 - x10

150 





BLOC 2 FACES ROSE

Lavable. Une face pour lisser, l'autre pour lustrer les ongles naturels.

PINK 2-WAY NAIL BLOCK

Washable. One side for smoothing and the other for buffing natural nails.

122216

BLOC POUR ONGLES 4 FACES

Un bloc polissoir en 4 étapes :

face 1 : limer / 2 : lisser / 3 : polir / 4 : faire briller, le tour est joué !

4-WAY NAIL BLOCK

Four steps to perfect nails: 1: filing / 2: smoothing / 3: polishing / 4: buffing.

It's as easy as that!

122218



BLOC 4 FACES

2 faces noires pour limer, 1 gris foncé pour lustrer, 1 blanc pour lisser.

4-WAY BLOCK

2 black faces for filing, 1 dark grey for buffing and 1 white for smoothing.

122213

BLOC POLISSOIR ERGONOMIQUE

Prise en main facile. Côté rose pour lisser, côté blanc pour lustrer.

ERGONOMIC BUFFER

Easy grip. Pink side for smoothing, white side for buffing.

122217



MINI BLOC 4 FACES

Bleu pour limer, rose pour effacer les rayures, blanc pour lisser, gris pour lustrer.

4-WAY MINI BLOCK

Blue for filing, pink for removing scratches, white for smoothing and grey for buffing.

122130

PIERRE PONCE MANUCURE - PÉDICURE WHITE-BLUE PUMICE STONE MANICURE AND PEDICURE

123002



| COUPELLERIE / COUPELLERIE

COUPE-CUTICULES DESIGN

Très pratique grâce à son embout protecteur, il permet de couper en douceur les petites peaux mortes du contour de l'ongle. Lames courbes en acier chromé.

STYLISH CUTICLE CUTTER

Very practical with its protective end piece. For gently cutting off small pieces of dead skin around the nail. Curved chrome-plated-steel blades.

300217



PINCE À ONGLES

NAIL NIPPER

300002 - 11,5 cm, becs concaves, fermetur automatique. Acier inoxydable. Concave jaws, self opening. Stainless steel.

300001 - 11,5 cm, becs 3 mm, fermetur automatique. Acier inoxydable. 3 mm jaws, self opening. Stainless steel.

PINCE À ENVIES CUTICLE NIPPER

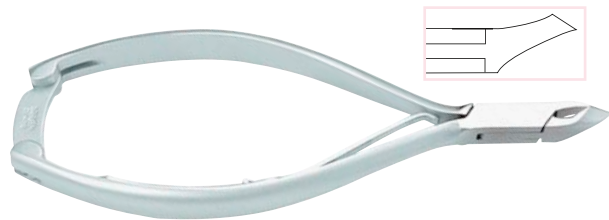

PINCE À ENVIES ULTRA LÉGÈRE EXTRA-LIGHT CUTICLE NIPPER

300115 - 12,5 cm, becs 2,5 mm, fermetur automatique. Acier inoxydable Excellcut. 2,5 mm jaws, self opening. Stainless steel Excellcut.

COUPE-ONGLES

Précis et efficace.

NAIL CLIPPERS

Accurate and effective.

300016 - 8 cm - Acier chromé / Chrome-plated steel.





REPOUSSE-CHAIR DESIGN

Un outil design et ergonomique pour repousser les cuticules et nettoyer sous les ongles.

STYLISH CUTICLE PUSHER

A stylish, ergonomic tool for pushing back cuticles and cleaning underneath nails.

300216

GOUGE REPOUSSE-CHAIR CUTICLE PUSHER / GOUGE

300211 - 14 cm, largeurs 9 mm & 5 mm. Acier inoxydable.
Widths 9 mm & 5 mm. Stainless steel.



300212



300213



300214



INSTRUMENT DOUBLE GOUGE/REPOUSSE-CHAIR DOUBLE-ENDED INSTRUMENT, CUTICLE PUSHER/GOUGE

300212 - 13,5 cm
largeurs 9 mm & 5 mm
Incurvé. Acier inoxydable
widths 9 mm & 5 mm,
curved. stainless steel

300213 - 13 cm
largeurs 9 mm & 4,5 mm
Carré. Acier inoxydable
widths 9 mm & 5 mm,
square. stainless steel

300214 - 13 cm
largeurs 9 mm & 4,5 mm
Rond. Acier inoxydable
widths 9 mm & 5 mm,
round. stainless steel

OUTIL QUICK REMOVER

Idéal pour retirer au plus vite les vernis semi-permanents I-LAK et 1-LAK, Gel sculpt et la résine, sans endommager l'ongle.

QUICK REMOVER TOOL

The perfect way to remove I-LAK and 1-LAK semi permanent nail lacquers, Gel Sculpt and acrylic resin without damaging your nails.

300219 - Acier inoxydable / Stainless steel.



**CISEAUX À ONGLES
NAIL SCISSORS**

300008 - 10 cm, lames courbes. Acier chromé.
Curved blades. Chrome-plated steel.

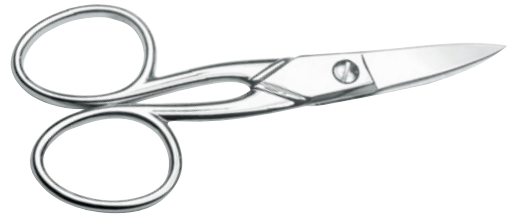

**CISEAUX À ONGLES ET À ENVIES
NAIL AND CUTICLE SCISSORS**

300014 - 9,5 cm, lames courbes. Acier chromé.
Curved blades. Chrome-plated steel.

**CISEAUX À ENVIES
CUTICLE SCISSORS**

300009
10 cm, lames droites.
Acier chromé.
Straight blades
Chrome-plated steel.

300010
10 cm, lames courbes.
Acier chromé.
Curved blades
Chrome-plated steel

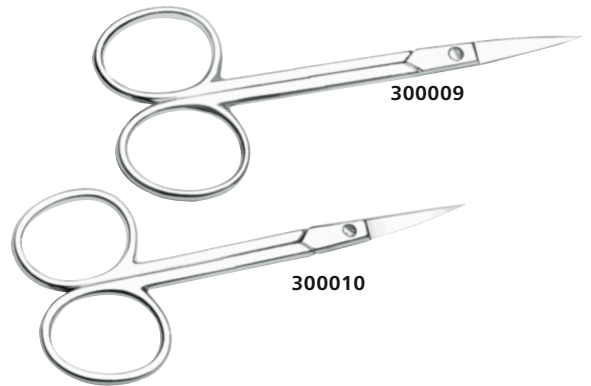

**CISEAUX À ENVIES ERGONOMIQUES
ERGONOMIC HANGNAIL SCISSORS**

300017 - 9 cm, becs 5 mm. Acier inoxydable.
5 mm jaws. Stainless steel

SET MANUCURE

Un petit set pratique et girly pour avoir tout votre nécessaire à portée de main en toutes circonstances. Contenu : 1 coupe-ongles, 1 paire de ciseaux, 1 pince à épiler et 1 lime.

MANICURE SET

A practical and very girly little manicure set that ensures you have everything to hand whatever you're doing. Contents: 1 pair of nail clippers, 1 pair of scissors, 1 pair of tweezers and 1 nail file.

300227 - Fermé / Closed : 12 x 6.8 x 2.6 cm, Ouvert / Open : 12 x 15 x 1.3 cm



ENTRAÎNEMENT - PRÉSENTATION TRAINING - PRESENTATION



NAIL TRAINER

Main d'entraînement complètement articulée fixée sur un bras flexible reproduisant la main humaine, idéal pour un entraînement performant. Fixation par étau. Contient 1 main + 1 bras flexible + 1 étau + 1 manuel d'explication + 1 support dvd + 2 cartes de progression + réassort 100 ongles d'entraînement. Realistic, fully jointed practice hand attached to a flexible arm, ideal for effective training. With attachment stand. Contains 1 hand + 1 flexible arm + 1 stand + 1 instruction manual + 1 information DVD + 2 training cards + supply of 100 practice nails.

147030

LOT 100 ONGLES POUR NAIL TRAINER PACK OF 100 NAILS FOR NAIL TRAINER

147031



MAIN D'ENTRAÎNEMENT + SUPPORT + 20 PROTÈGE-ONGLES

Doigts flexibles. Réaliste, compatible avec le gel, la résine et la pose de capsules. Résiste au dissolvant.

PRACTICE HAND + STAND + 20 NAIL PROTECTORS

Flexing fingers. Realistic, compatible with gel, acrylic resin and tips. Resistant to nail lacquer remover.

147004

DOIGT D'ENTRAÎNEMENT PRACTICE FINGER

147010



50 PROTÈGE-ONGLES POUR MAIN 147004
50 NAIL PROTECTORS FOR HAND 147004
147005 - x50



ONGLIER VIERGE
BLANK NAIL LACQUER PALETTE
142520 - ø 10,5cm

ONGLIER VIERGE
Pack économique !
BLANK NAIL LACQUER PALETTE
Great value pack!
142523 - x 10



NUANCIER ÉVENTAIL 30 ONGLES À DÉCORER
SET OF 30 DECORATING NAILS FOR COLOUR DISPLAY
142521

RECHARGE 30 ONGLES À DÉCORER
POUR NUANCIER
30 SPARE DECORATING NAILS FOR COLOUR DISPLAY SET
142522





“ **RITUEL INCONTOURNABLE, RÉALISEZ DES CRÉATIONS À L'INFINI AVEC DES PRODUITS DE QUALITÉ.** ”

Toujours à l'affût des nouvelles tendances, la marque Peggy Sage propose une offre complète de produits de maquillage qui s'adaptent à votre peau et sa carnation. Toutes les envies sont réalisables pour des looks extravagants ou plus subtiles. Chaque produit est facile d'utilisation et accessible à tous les professionnels pour des résultats d'une qualité professionnelle. Retrouvez nos tutoriels et inspirations pour vous accompagner dans toutes vos créations.

“ **ENDLESS SCOPE FOR CREATIVITY WITH HIGH-QUALITY PRODUCTS FOR EVERY ESSENTIAL BEAUTY RITUAL.** ”

Always on the look-out for the latest new trends, the Peggy Sage brand boasts a comprehensive range of make-up products for every skin type and complexion. Anything goes, from bold, in-your-face statements to more subtle looks. Every product is easy to use and accessible to any professional, for professional-quality results. Use our tutorials and inspiring ideas to help inspire your creativity.

TEINT / COMPLEXION 167
 SOURCILS / EYEBROWS 186
 YEUX / EYES 190

LÈVRES / LIPS 212
 ACCESSOIRES / ACCESSORIES 222
 EMBELLISSEMENT DU REGARD
 GAZE ENHANCEMENT 242



MAQUILLAGE / MAKE-UP

TEINT / COMPLEXION

Le secret pour un maquillage réussi et longue tenue ? Un teint parfait !

Afin d'illuminer votre visage, Peggy Sage vous propose une gamme complète pour le teint : base de teint, correcteurs, anti-cernes, etc. Trouvez le produit qui vous convient !

The secret to long-hold make-up that really works? A perfect complexion!

Brighten your face with the complete Peggy Sage range of complexion products: make-up base, concealer, dark circle concealer, and more. There's a product that's right for you!

| PREMIER TEINT / PRE MAKE-UP BASE

BASE DE TEINT

La gamme base de teint de Peggy Sage a été entièrement retravaillée pour lisser, unifier et illuminer la peau, tout en estompant les petites imperfections.

À appliquer sur le visage, après les soins quotidiens, par-dessous le maquillage, pour un fini velouté à souhait. À chaque carnation, une base adaptée...

MAKE-UP BASE

Peggy Sage's range of make-up bases has been carefully developed to smooth, even up and illuminate your skin while fading those little imperfections. Apply them to your face after your daily skincare routine and before your make-up, for a delightfully velvety finish. We offer a base for every complexion colouring...

échantillon / sample

30 ml



800840
matifiante / mattifying

800841
échantillon / sample



800845
pores invisibles
invisible pores

800846
échantillon / sample



800850
illuminatrice / illuminating

800851
échantillon / sample



800855
verte / green

800856
échantillon / sample



800860
mauve

800861
échantillon / sample



800865
rose / pink

800866
échantillon / sample



800870
pêche / peach

800871
échantillon / sample



800875
jaune / yellow

800876
échantillon / sample



800880
caramel

800881
échantillon / sample

CORRECTEUR / CONCEALER

ROSE / PINK
JAUNE / YELLOW
VERT / GREEN
ORANGE
LAVANDE / LAVENDER

IMPERFECTIONS

réveille les teints clairs et gris brightens light and grey complexions
estompe les cernes et les imperfections violacées softens shadows under the eyes and purplish imperfections
rougeurs (boutons, couperose) corrects red patches (pimples, blotches)
cernes bleus, éclat des peaux mates softens blue shadows, brings back the glow to olive skins
teint terne / jaune brightens dull, yellow complexions



PAPIERS MATIFIANTS

Un étui compact contenant 50 papiers ultra doux pour matifier la peau instantanément. Muni d'un petit miroir, cette petite pochette est capable de rendre service à tout moment.

BLOTTING PAPIERTJES

A compact case containing 50 ultra-soft papers that instantly matify your skin. The little case features a little mirror, so it comes in handy whenever you need it.

801553 - 50 feuilles + miroir / 50 sheets + mirror

FIXATEUR DE MAQUILLAGE

Prépare la peau à recevoir le maquillage et permet une meilleure tenue de celui-ci tout au long de la journée.

MAKE-UP FIXER

Prepares your skin for the make-up and gives it a longer lasting hold throughout the day.

804000 - 200 ml





BB CRÈME TEINT SANS DÉFAUT

Retrouvez une peau parfaite avec la BB crème Peggy Sage. À la frontière entre soin et maquillage, ce soin 5-en-1 hydrate et unifie le teint, gomme les imperfections, révèle l'éclat de la peau et la protège des UV (SPF 20).

FAULTLESS COMPLEXION BB CREAM

Restore perfect skin with Peggy Sage BB cream. A cross between a skincare product and make-up, this 5-in-1 cream hydrates and evens out the complexion, covers blemishes, brings out your skin's radiance and protects it from UV light (SPF 20).

échantillon / sample

40 ml



400660
clair
40 ml

400661
échantillon
sample



400665
beige
40 ml

400666
échantillon
sample



400670
doré
40 ml

400671
échantillon
sample



400675
foncé
40 ml

400676
échantillon
sample



403310
bonne mine
voor een stralende teint
40 ml



403315
anti rougeur
tegen rode vlekken
40 ml

CC CRÈME

Retrouvez la peau parfaite dont vous avez toujours rêvé ! Instantanément, ce soin 6-en-1 nouvelle génération sublime, illumine, hydrate, unifie le teint et camoufle les imperfections.

Enjoy the perfect skin you've always dreamed of!

This new-generation 6-in-1 cream instantly beautifies, brightens, moisturizes and protects (SPF15), evening up your complexion and hiding imperfections.

40 ml

| FOND DE TEINT / FOUNDATION



FOND DE TEINT FLUIDE

Une texture fluide et d'une extrême finesse qui se fond à la peau pour un teint absolument parfait et inaltérable tout au long de la journée. Sublimé en transparence, le teint se fait doux et rayonnant comme de la soie.

FLUID FOUNDATION

An extremely delicate fluid texture that melts into the skin for an absolutely perfect complexion that remains constant all day long. Your complexion is stunningly clear, as soft and radiant as silk.

30 ml

échantillon / sample



801280
beige clair

801281
échantillon
sample



801285
beige neutre

801286
échantillon
sample



801250
beige porcelaine

801251
échantillon
sample



801205
beige naturel

801206
échantillon
sample



801230
beige sable

801231
échantillon
sample



801235
beige noisette

801236
échantillon
sample



801240
beige doré

801241
échantillon
sample



801210
beige hâlé

801211
échantillon
sample



801245
beige miel

801246
échantillon
sample



801220
beige cuivré

801221
échantillon
sample



801255
bronze

801256
échantillon
sample



801260
mocha

801261
échantillon
sample



801265
ambré

801266
échantillon
sample



801270
cacao

801271
échantillon
sample



801275
espresso

801276
échantillon
sample

Luminous Skin

FOND DE TEINT PERFECTEUR DE PEAU

Ce fond de teint à la texture fondante et ultra couvrante garantit un teint absolument parfait et inaltérable tout au long de la journée. Votre peau est éclatante et uniformisée. Elle retrouve vitalité et luminosité en un seul geste.

SKIN PERFECTOR FOUNDATION

This ultra-covering foundation with a melt-in texture guarantees an absolutely perfect, smudge-free complexion all day long. It leaves your skin looking radiant and even, restoring its vitality and luminosity in one go.

échantillon / sample

30ml



801935
beige clair
801936
échantillon
sample



801940
beige neutre
801941
échantillon
sample



801850
beige naturel
801851
échantillon
sample



801865
beige sable
801866
échantillon
sample



801870
beige noisette
801871
échantillon
sample



801875
beige doré
801876
échantillon
sample



801855
beige hâlé
801856
échantillon
sample



801880
beige miel
801881
échantillon
sample



801860
beige cuivré
801861
échantillon
sample



801910
bronze
801911
échantillon
sample



801915
mocha
801916
échantillon
sample



801920
ambré
801921
échantillon
sample



801925
cacao
801926
échantillon
sample



801930
espresso
801931
échantillon
sample

Bliss Skin



FOND DE TEINT SKINBLISS

Ce fluide révolutionnaire se lie naturellement à la peau, offrant un teint sur-mesure et une sensation de confort et de légèreté. Il procure un fini velouté pour une tenue inaltérable tout au long de la journée. Sa texture impalpable donne l'impression unique de ne rien porter sur la peau.

SKINBLISS FOUNDATION

This revolutionary fluid binds naturally with the skin, creating a personalized colour and a sensation of comfort and lightness. It produces a velvety finish with an unwavering hold that lasts all day. Its ethereal texture gives your skin a unique sensation of nakedness.

30ml

échantillon / sample



801765
beige clair
801766
échantillon
sample



801770
beige neutre
801771
échantillon
sample



801700
beige naturel
801701
échantillon
sample



801715
beige sable
801716
échantillon
sample



801720
beige noisette
801721
échantillon
sample



801725
beige doré
801726
échantillon
sample



801705
beige hâlé
801706
échantillon
sample



801735
beige miel
801736
échantillon
sample



801710
beige cuivré
801711
échantillon
sample



801740
bronze
801741
échantillon
sample



801745
mocha
801746
échantillon
sample



801750
ambré
801751
échantillon
sample



801755
cacao
801756
échantillon
sample



801760
espresso
801761
échantillon
sample

FOND DE TEINT MAT

Ce fond de teint à la formule non grasse permet de couvrir les imperfections et d'unifier le teint, pour un résultat irréprochable, sans brillance. Le teint est sublimé d'un voile mat imperceptible et assure confort et légèreté tout au long de la journée.

MAT FOUNDATION

This foundation with a non-oily formula covers imperfections and evens up your complexion for perfect results with no shininess. It leaves your face feeling comfortable and light all day long, enhancing your complexion with an imperceptible light mat covering.

échantillon / sample

30 ml



801465
beige clair
801466
échantillon
sample



801470
beige neutre
801471
échantillon
sample



801305
beige naturel
801306
échantillon
sample



801330
beige sable
801331
échantillon
sample



801335
beige noisette
801336
échantillon
sample



801340
beige doré
801341
échantillon
sample



801310
beige hâlé
801311
échantillon
sample



801345
beige miel
801346
échantillon
sample



801320
beige cuivré
801321
échantillon
sample



801385
bronze
801386
échantillon
sample



801390
mocha
801391
échantillon
sample



801395
ambré
801396
échantillon
sample



801415
cacao
801416
échantillon
sample



801460
espresso
801461
échantillon
sample



FOND DE TEINT POUDRE

Le fond de teint poudre a une formule micronisée, d'une finesse spectaculaire pour un teint parfait. Fond de teint et poudre à la fois, il apporte une très bonne couvrance et une grande facilité d'application tout en laissant respirer la peau. Il est longue tenue et s'applique à sec, au pinceau, à l'éponge ou à la houppette.

POEDER FOUNDATION

This micronized-formula powder foundation is amazingly fine, for a perfect complexion. Both a foundation and a powder, it provides excellent coverage and is really easy to apply, while still allowing the skin to breathe. This long-wear powder can be applied dry or with a brush, sponge or powder puff.

8g

godet / doosje



801900
beige clair
801901
godet / part



801905
beige neutre
801906
godet / part



801800
beige naturel
801801
godet / part



801815
beige sable
801816
godet / part



801820
beige noisette
801821
godet / part



801825
beige doré
801826
godet / part



801805
beige hâlé
801806
godet / part



801830
beige miel
801831
godet / part



801810
beige cuivré
801811
godet / part



801835
bronze
801836
godet / part



801840
mocha
801841
godet / part



801845
ambré
801846
godet / part



801890
cacao
801891
godet / part



801895
espresso
801896
godet / part

AJUSTEUR DE FOND DE TEINT

Obtenir la teinte de fond de teint parfaitement adaptée à votre carnation grâce aux ajusteurs de teinte Peggy Sage. Quelques gouttes suffisent pour créer la couleur naturelle de votre peau qu'elle soit hâlée en été ou plus pâle en hiver!

FOUNDATION ADJUSTER

With the Peggy Sage foundation adjusters, now you can have foundation that matches your colouring perfectly. A few drops are all you need to match your skin's natural colour, whether it's tanned in the summer or paler in the winter.

15 ml

NEW



800730
effet éclaircissant
lightener



800735
effet fonçante
darkener



802715
mat



802717
irisé

PALETTE MODELEURS VISAGE

La palette de modeleurs visage offre un duo de poudres compactes afin de sculpter et corriger les volumes du visage. La teinte claire accentue les volumes tandis que la teinte foncée les diminue. Les défauts sont atténués, les traits embellis grâce à un jeu de contrastes entre ombres et lumières.

FACE-SHAPING COSMETICS PALETTE

This face-shaping cosmetics palette features a duo of pressed powders that you can use to sculpt and correct the shape of your face. The light colour accentuates volume while the dark colour reduces it. The result? The contrasting light-and-shade effect hides flaws and brings out the beauty in your face.

802715 - 2 x 5 g - mat

802717 - 2 x 5 g - irisé

PALETTE CONTOURING

Une palette composée de 5 teintes s'adaptant à toutes les carnations de peau pour exceller dans l'art du contouring. Sa texture crémeuse permet de sculpter, définir et illuminer le visage. Quelques minutes suffisent désormais pour relever les pommettes, affiner le nez et sculpter la mâchoire afin de faire ressortir la beauté naturelle.

CONTOUR PALETTE

A palette of 5 shades to match every complexion for excellence in the art of contouring. With their creamy texture, these contouring colours can be used for sculpting, defining and illuminating the face. Now you can highlight your cheekbones, refine your nose and sculpt your jaw to bring out your natural beauty in just minutes.

802705 - 5 x 3 g



| CORRECTEURS DE TEINT / CONCEALER



3g

CORRECTEUR DE TEINT

Il masque les cernes et camoufle les petites imperfections de la peau.

CONCEALER

They hide dark circles and cover up the skin's little imperfections.

3g



803500
blanc



803510
chair



803515
ivoire



803520
pistache



803525
abricot



803530
soleil



803535
beige



803555
vert



803560
orange



803565
jaune



803570
lavande

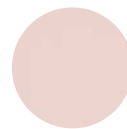

803575
rose



803580
acajou



803585
caramel



803595
chestnut



803495
brun

CORRECTEUR / CONCEALER

CORRECTEUR / CONCEALER	IMPERFECTIONS
ROSE / PINK	réveille les teints clairs et gris brightens light and grey complexions
JAUNE / YELLOW	estompe les cernes et les imperfections violacées softens shadows under the eyes and purplish imperfections
VERT / GREEN	rougeurs (boutons, couperose) corrects red patches (pimples, blotches)
ORANGE	cernes bleus, éclat des peaux mates softens blue shadows, brings back the glow to olive skins
LAVANDE / LAVENDER	teint terne / jaune brightens dull, yellow complexions

LuminousSkin

CORRECTEUR DE TEINT LUMINOUSKIN

Un correcteur à la couvrance optimale pour camoufler les cernes et autres petites imperfections et garantir un regard frais et reposé. Facile à utiliser à l'aide de son applicateur à embout floqué.

COLOR NEUTRALIZING LUMINOUSKIN

An ultra-covering color neutralizing that hides dark circles and other little imperfections, guaranteeing you a fresh, rested-looking complexion. Features a flock-tipped applicator for easy application.

échantillon / sample

3 ml



801140
vanille

801141
échantillon
sample



801145
beige

801146
échantillon
sample



801150
biscuit

801151
échantillon
sample



801160
ivory

801161
échantillon
sample



801165
cool sand

801166
échantillon
sample



801170
warm Beige

801171
échantillon
sample



801175
vert

801176
échantillon
sample



801180
rose

801181
échantillon
sample



801185
jaune

801186
échantillon
sample



PALETTE CORRECTEURS DE TEINT

5 teintes pour camoufler toutes les imperfections.

CONCEALER PALETTE

5 shades for hiding all kinds of imperfections.

803550 - 5 x 1,5g

| ANTI-CERNES / DARK CIRCLES CONCEALER



110090
moyen



110091
clair



110095
ivoire



ANTI-CERNES CORRECTEUR

Un stick correcteur de teint et anti-cernes pour un teint sans défaut.

DARK CIRCLES CONCEALER - CORRECTOR

A general and dark-circle concealer stick for a faultless complexion.

3,8g

CRAYON ANTI-CERNES

Hautement pigmentés, ces crayons masquent cernes et petites imperfections pour un teint unifié. Son format crayon permet une application rapide, précise et facile.

DARK CIRCLE CONCEALER PENCIL

These pencils with a high pigment content hide dark circles and little blemishes, creating an even complexion. They come as a pencil for fast, accurate and easy application.

taille-crayon 130282 sans le réducteur blanc
pencil sharpener 130282 without white diameter reducer



131301
chair - 2,62g



131302
naturel - 2,49g

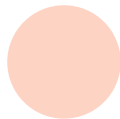

801100
chair



801105
naturel



801110
sable

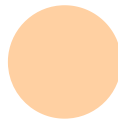

801115
beige

ANTI-CERNES TWIST

Une texture soyeuse et riche pour une tenue longue durée et un teint zéro défaut.

TWIST DARK CIRCLE CONCEALER PENCIL

A silky, rich texture for a long-lasting hold and a zero-defect complexion.

1,6ml

ANTI-CERNES DÉFATIGANT REGARD

Une mine radieuse et un regard visiblement défatigué en un seul geste.

ANTI-CERNES DÉFATIGANT REGARD

A radiant look and a visibly refreshed gaze in one go.

échantillon / sample

15 ml



801120
beige chair

801121
échantillon
sample



| POUDRES / POWDER

POUDRE COMPACTE EXPRESS

Sa formule SPF 30 protège la peau des rayons néfastes du soleil.

EXPRESS PRESSED POWDER

Its SPF 30 formula helps protect the skin from the harmful effects of sunlight.

godet / part

9g



802570 - beige

802571
godet / part



802575 - abricot

802576
godet / part



802580 - bronzée

802581
godet / part



802585 - sable

802586
godet / part



802590 - transparent

802591
godet / part



802720
sun kissed

802721
godet / part



802725
sun cherished

802726
godet / part



802730
sun beloved

802731
godet / part



802735
sun treasured

802736
godet / part

POUDRE COMPACTE PERFECTRICE

Cette jolie poudre, aux nuances complémentaires, maquille parfaitement le teint et apporte perfection et lumière.

PERFECTING PRESSED POWDER

This pretty powder in complementary shades is the perfect complexion make-up, adding perfection and light to your face.

9g

godet / part

POUDRE LUMIÈRE VISAGE ET CORPS

Un teint hâlé et une bonne mine toute l'année.

ILLUMINATING POWDER FACE AND BODY

A tanned complexion and healthy glow all year round.

30g



802350
terre cuivrée



802355
terre ambrée



802360
terre rosée



802365
terre hâlée





POUDRE BRONZANTE

Bronzage naturel, effet bonne mine.

TANNING POWDER

For a natural-looking tan that'll leave you looking great.

godet / part

10 g



802330
honey

802331
godet / part



802335
almond

802336
godet / part



802340
chestnut

802341
godet / part



802345
walnut

802346
godet / part

POUDRE LUMIÈRE IRISÉE

Parsemées de petites nacres, ces poudres illuminent le teint qu'il soit porcelaine ou hâlé. Leur texture "cuite au four" résiste mieux tout au long de la journée.

SHIMMERING ILLUMINATING POWDER

With a sprinkling of pearly particles, these powders brighten both porcelain and bronzed complexions. With an "oven-baked" texture for an improved hold that lasts all day.

12 g

godet / part



802250 - abricot

802251 - godet / part



802255 - caramel

802256 - godet / part



802265 - pêche

802266 - godet / part

POUDRE MOSAÏC

Ces poudres permettent de donner un effet bonne mine et d'embellir en un seul geste le visage et le décolleté. Elles éclairent le teint de mille éclats en déposant sur la peau un voile de lumière subtilement coloré.

MOSAIC POWDER

These powders create a healthy glow, beautifying the face and décolleté in one go. They brighten the complexion with an attractive sheen by leaving a subtly coloured sheer covering of brightness on the skin.

godet / part

7 g



802600
touche d'or

802601
godet / part



802605
terre brunie

802606
godet / part



802610
désert rose

802611
godet / part



802615
été indien

802616
godet / part



802620
sienne brûlée

802621
godet / part



802625
soleil d'hiver

802626
godet / part



802135
pink sand beach

NEW

POUDRE DE TEINT

Des nuances rayonnantes pour une mise en beauté adaptée à toutes les carnations.

POWDER BLUSH

Radiant colours that beautify any complexion.

10,5g



802125
Namibia



802130
Hawai

POUDRE LIBRE

Elles fixent le fond de teint et veloutent le teint tout au long de la journée.

LOOSE POWDER

They fix the foundation and give the complexion a velvety look that lasts all day.

25g



803015
sable



803130
beige



803150
ambrée



803160
abricot



803195
transparente

ENLUMINEUR / ILLUMINATOR

ILLUMINEUR CORPS ET VISAGE

Indispensable pour sublimer votre peau pendant les belles journées ensoleillées. Cet illuminateur rendra votre peau dorée et séduisante. A appliquer uniformément sur tout le corps, sur le visage en base de maquillage ou par-dessus le fond de teint sur les pommettes, les arcades sourcilières et l'arête du nez.

BODY AND FACE ILLUMINATOR

The must-have way to beautify your skin on fine, sunny days. This illuminator will leave your skin looking lightly bronzed and attractive. Apply evenly all over your body, on your face as a make-up base or on top of foundation on your cheekbones, the arcs underneath your eyebrows and on the bridge of your nose.

801558 - 30 ml



803485
Enlumineur liquide
Liquid illuminator



803490
Bronzeur liquide
Liquid bronzer

ENLUMINEUR BRONZEUR LIQUIDE - OH MY GLOW !

« Oh my glow ! » vous apporte un éclat instantané, il capture et diffuse la lumière pour un résultat aussi radieux que lumineux. Enrichie de pigments perlés, sa texture légère et confortable apportera un fini velouté et nacré à votre peau. Appliquer-le par petites touches au-dessus de votre maquillage pour mettre en valeur vos pommettes et votre regard. Vous pouvez aussi le mélanger à votre base de teint ou votre fond de teint pour illuminer votre visage.

OH MY GLOW! LIQUID ILLUMINATOR BRONZER

Oh my Glow! gives you instant radiance, capturing and diffusing the light for stunning, radiant results. Enriched with pearly pigments, its light, comfortable texture gives your skin a velvety pearl finish. Apply sparingly on top of your make-up to bring out your cheekbones and eyes. You can also mix it with your make-up base or foundation to illuminate your face.

15 ml

CRAYON ENLUMINEUR - YEUX, LÈVRES & JOUES

Un tout en un qui vous embellit en un temps record ! Les Holo Highlighter crémeux et waterproof s'utilisent pour rehausser les volumes de votre visage mais également en ombre à paupières et en rouge à lèvres.

ILLUMINATOR PENCIL FOR EYES, LIPS & CHEEKS

An all-in-one product for a beautiful face in record time! These creamy, waterproof holographic highlighters not only highlight the shape of your face, you can also use them as an eye shadow and lipstick.

4,9 g



803475
gold



803480
rose gold

| FARD À JOUES / BLUSH



800510

rose satin

800511

godet / part



800530

saumon

800531

godet / part



800540

orange

800541

godet / part



800545

beige rosé

800546

godet / part



800550

mangue

800551

godet / part



800560

pêche

800561

godet / part

FARD À JOUES

Une texture poudre facile à travailler et à estomper.

BLUSH

A powder texture easy to work and blend in.

godet / part

3g



800570

brique

800571

godet / part



800580

abricot

800581

godet / part



VELOURS BLUSH 2 EN 1 - LÈVRES & JOUES

La texture crémeuse et fondante du Velours blush colore les joues et les lèvres de manière subtile et naturelle pour un teint frais et éclatant tout au long de la journée. Facile à appliquer, il apporte en un instant un fini velouté et mat.

Utilisation : A l'aide de l'applicateur appliquez 3 points sur le haut de chaque pommette et tapoter au doigt pour estomper. Définissez le contour des lèvres et remplissez pour un effet lèvres de velours.

2-IN-1 VELVET BLUSH - FOR LIPS & CHEEKS

The creamy, melt-in texture of this velvet blush subtly colours your cheeks and lips to create a fresh, stunning, natural-looking complexion that lasts all day. Easy to apply, it adds a velvety matt finish in an instant.

Instructions: Using the applicator, apply 3 dabs to the top of each cheekbone and tap with your finger to blend them in. Outline your lips and fill them with velvet blush for velvety-looking lips.

117450 - 7 ml





MAQUILLAGE / MAKE-UP

SOURCILS / EYEBROWS

Dessinez votre ligne de sourcils aisément pour un regard structuré en un instant !
Des sourcils bien travaillés sont essentiels pour donner du caractère et de la personnalité à votre visage.
Peggy Sage vous accompagne pour dessiner, remplir, épaissir ou affiner vos sourcils avec précision.

The easy way to shape your eyebrows for a structured gaze in an instant!
Well-groomed eyebrows are essential to giving your face character and personality. When it comes to drawing on, filling in, thickening or thinning your eyebrows with precision, Peggy Sage has it covered.

CRAYON À SOURCILS

La mine permet de redessiner la courbe du sourcil et la brosse estompe le trait pour un fini naturel.

EYEBROW PENCIL

Use the pencil to redraw the curve of the eyebrows and the brush to blend in the line for a natural finish.

1,1 g - taille-crayon / pencil sharpener 130280/130283



130213
noir



130214
havane



130215
marron



130216
blond



130217
gris



130218
cendré



130219
taupe

CRAYON À SOURCILS DISCIPLINE

Brosser vos sourcils vers le bas, compléter la ligne de vos sourcils avec la mine noisette, brosser vos sourcils dans le sens habituel puis fixer-les avec la mine gloss incolore. La couleur et le gloss incolore se mélangent pour parfaire subtilement la ligne de vos sourcils.

EYEBROW PENCIL DISCIPLINE

Brush your eyebrows downwards, complete the line of your eyebrows using the hazelnut pencil, brush your eyebrows in the usual direction and then fix them with the colourless gloss pencil. The colour and colourless gloss mix, subtly creating a perfect line for your eyebrows.

130250 - 1,13 g - taille-crayon / pencil sharpener 130280/130283



CRAYON À SOURCILS

Un crayon à sourcils rétractable à la texture crémeuse longue tenue. Waterproof, il ne coule pas et ne perd rien de son intensité. Sa mine ultra fine permet de dessiner, combler et structurer les sourcils de manière naturelle et précise. Sa petite brosse en spirale coiffe les sourcils et estompe le crayon.

EYEBROW PENCIL

An easy-to-apply retractable eyebrow pencil with a creamy, long-wear texture that glides gently onto the skin. This waterproof pencil does not run and its intensity never fades. With its ultra-fine lead, it's great for drawing, filling in and structuring eyebrows in a neat, natural-looking way. Use the little spiral brush to tidy your eyebrows and blend in the pencil.

0,09 g



130290
cendré



130291
taupe



130292
brun

CRAYON SOURCILS AVEC FIBRES

Redonnez du volume et de la matière à vos sourcils grâce aux crayons XL Brow Fiber. Leur formule riche en fibres comblera en quelques instants les sourcils irréguliers. Un résultat intense mais naturel !

EYEBROW PENCIL WITH FIBRES

Restore volume and body to your eyebrows with these XL Brow Fiber eyebrow pencils. Their fibre-rich formula fills in uneven eyebrows in a flash, for intense but natural-looking results!

1,7 g



130221
clair



130222
marron cendré



130223
marron chaud



130224
foncé

FEUTRE À SOURCILS

Il donne volume et intensité aux sourcils tout en délicatesse.

EYEBROW MARKER

The gentle way to give your eyebrows volume and intensity.

1,1 ml



130251
taupe



130252
brun



130270
cendré



130271
taupe



130272
brun

POUDRE SOURCILS

Une poudre libre longue tenue pour ombrer les zones clairsemées et structurer parfaitement les sourcils. Elle se fond naturellement à la couleur des sourcils et révèle la beauté du regard. Son applicateur mousse de forme allongée permet un résultat ultra précis.

EYEBROW POWDER

A long-wear loose powder for darkening sparse areas and perfecting the structure of your eyebrows. It blends in naturally with the colour of your eyebrows, bringing out the beauty in your gaze. The long foam applicator produces ultra-precise results.

1 g

CRAYON À SOURCILS + ILLUMINATEUR

D'un côté, une mine brune permettant d'ombrer les zones clairsemées et de définir les sourcils, de l'autre, une mine rose pâle rendant le regard plus lumineux et camouflant les poils naissants.

EYEBROW PENCIL + ILLUMINATOR

One contains a brown lead for darkening sparse areas and adding definition to your eyebrows, and the other has a pale pink lead that brightens your gaze and covers up new hairs.

130255 - 3,2g - châtain

taille-crayon 130282 sans le réducteur blanc
pencil sharpener 130282 without white diameter reducer



CRAYON DUO ENLUMINEUR SOURCILS

Deux côtés complémentaires qui soulignent l'arc sourcilière et créent des zones lumineuses pour rehausser les volumes.

EYEBROW ILLUMINATOR DUO PENCIL

Two complementary ends for highlighting the arc underneath your eyebrows and adding lighter areas to create relief.

130256 - 4,8g



PALETTE À SOURCILS

Cette palette à sourcils contient une poudre pour combler et définir les sourcils ainsi qu'une cire pour modeler et fixer.

EYEBROW PALETTE

This eyebrow palette contains a powder for filling in and adding definition to your eyebrows and a wax for shaping and setting them.

Cire / Wax : 2,5g - Poudre / Powder : 3g



130241
taupe



130242
brun

FIXATEUR DE SOURCILS

Il redessine et discipline la ligne du sourcil tout en transparence.

EYEBROW FIXER

The invisible way to re-shape your eyebrows and keep them neat.

130231 - 2,2 ml - transparent





MAQUILLAGE / MAKE-UP

YEUX / EYES

Un regard nacré la journée et magnétique la nuit ? Sublimez vos yeux grâce à nos produits exceptionnels !

Associer nos crayons, eyeliners, ombres à paupière et mascaras pour créer des looks irrésistibles à l'infini !

Retrouver vos produits idéaux parmi nos larges panels de nuances et textures.

A shimmering gaze for daytime and magnetic look at night? Bring out your eyes with our amazing products!

Mix and match our different pencils, eyeliners, eye shadows and mascaras to create an endless variety of irresistible looks!

Choose the right products for you from our extensive selections of shades and textures.

OMBRES À PAUPIÈRES / EYE SHADOWS

BASE OMBRE À PAUPIÈRES

Appliquer au doigt ou au pinceau avant votre ombre à paupières pour une tenue impeccable.

EYE SHADOW BASE

Apply before eye shadow with your finger or a brush for an impeccable hold.

820095

10 ml - incolore



OMBRE À PAUPIÈRES LUMIÈRE MATE MATTE LUMIÈRE EYE SHADOW

3 g

godet / part



800200
blanc

800201
godet / part



800145
chair

800146
godet / part



850800
ebony magic

850801
godet / part



800170
moka

800171
godet / part

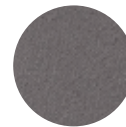

800205
noir

800206
godet / part



GODET OMBRE À PAUPIÈRES LUMIÈRE MATE PART MATTE LUMIÈRE EYE SHADOW

godet / part - 3 g



pourpre
800116
godet / part



fabulous grey
850826
godet / part

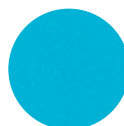

savannah rain
850841
godet / part



paradise lost
850846
godet / part



orange star
850856
godet / part

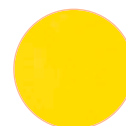

jaune deluxe
850861
godet / part



OMBRE À PAUPIÈRES LUMIÈRE IRISÉE
LUMIÈRE SHIMMERING EYE SHADOW

3g

godet / part



800265
blanc irisé
800266
godet / part



800395
blanc multicolore
800396
godet / part



850730
golden shell
850731
godet / part



850770
golden velvet
850771
godet / part



800150
beige or
800151
godet / part



800215
beige irisé
800216
godet / part



800350
beige
800351
godet / part



850775
misty sand
850776
godet / part



800280
intense bronze
800281
godet / part



850785
sienna chic
850786
godet / part



850650
hearty silk
850651
godet / part



850630
nude love
850631
godet / part



800290
shiny rose
800291
godet / part



800460
rose cherry
800461
godet / part



850655
sweet berry
850656
godet / part

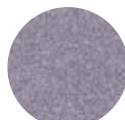

850925
sparkling dress
850926
godet / part

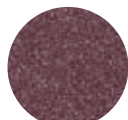

850605
violet magic
850606
godet / part



850760
crystal silver
850761
godet / part



800260
gris perle irisé
800261
godet / part



800255
gris bleu irisé
800256
godet / part



850780
nomad brown
850781
godet / part



850610
brun bucolic
850611
godet / part

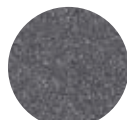

850765
black deluxe
850766
godet / part

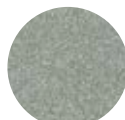

850715
silver green
850716
godet / part

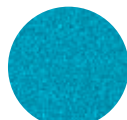

800435
turquoise irisé
800436
godet / part

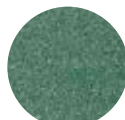

850740
trendy green
850741
godet / part

OMBRE À PAUPIÈRES LIQUIDE METALLIC GLOW

Pour un regard métallisé intense, l'ombre à paupières liquide Metallic Glow est le produit qu'il vous faut ! Vous allez adorer sa formule crème hyper couvrante aux reflets irisés qui vous procurera une sensation de confort durant toute la journée.

Son applicateur à embout floqué vous permettra une mise en beauté simple et rapide.

LIQUID EYE SHADOW METALLIC GLOW

Want to create an intense metallic gaze? You need Metallic Glow liquid eye shadow! You'll love its ultra-covering cream formula with a shimmer finish that feels comfortable all day long. And the flock-tipped applicator makes for quick and easy application.

6,5 ml



851005
pearl



851010
intense gold



851015
cuivre



851020
chocolate



851025
golden rose

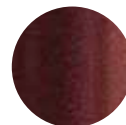

851030
bordeaux

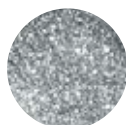

880080
argent



880081
or

PAILLETES

Idéales pour créer des effets pailletés sur le visage, le corps et les cheveux.

GLITTERS

Ideal for creating glittery effects on your face, body and hair.

3 g

PALETTE MAGNÉTIQUE PERSONNALISABLE

Une palette alliant un design moderne à une praticité indéniable. Sa surface aimantée permet de créer une multitude de combinaisons et d'harmonies d'ombres à paupières ou de poudres visage.

PERSONALISABLE MAGNETIC PALETTE

A make-up palette that combines a modern look with an extremely practical design. Use its magnetic surface to create a multitude of combinations and matching sets of eye shadows or face powders.

000743 - 9x9x1,5 cm
livrée vide / supplied empty

000744 - 11,5x15x1,5 cm
livrée vide / supplied empty



000743

000744



PALETTE OMBRES À PAUPIÈRES 3D METAL & MAT

Riches en pigment, les ombres à paupières 3D METAL et 3D MAT offrent un fini intense et texturé. Les ombres 3D ont une formule exceptionnellement onctueuse apportant une couleur intense et longue tenue! Faciles à travailler, les ombres 3D s'appliquent au doigt ou à l'aide d'un pinceau à paupières en silicone. Le petit plus : pour un look encore plus intense les appliquer avec un pinceau humidifié !

EYE SHADOWS PALETTE 3D METAL & MAT

These pigment-rich 3D METAL and 3D MAT eye shadows create an intense, textured finish. They have an exceptionally creamy formula with a deep, long-wear colour! Our 3D eye shadows are easy to apply with your finger or a silicone eye shadow brush.

Little extra: for an even more intense look, apply them with a damp brush!

840265 - 10x1,6g

PALETTE OMBRES À PAUPIÈRES NUDE SHADES

La palette « nude shades » vous permettront de réaliser de sublimes ombrés grâce aux 12 teintes aux couleurs dégradées et à la combinaison de formules irisée, mate et pailletée. Vos ombres à paupières s'utilisent au doigt ou à l'aide de l'applicateur double inclus.

EYE SHADOWS PALETTE - NUDE SHADES

Mix and match the 12 graduated colours in the Nude Shades eye shadow palette to create stunning make-up, combining shimmering, matte and glitter shades. Apply your eye shadows with your finger or the double-ended applicator included.

840245 - 12x2,2g





PALETTE OMBRES À PAUPIÈRES

4 palettes offrant un large choix de nuances harmonieuses.

EYE SHADOWS PALETTE

4 palettes with a wide choice of matching shades.

5x1,5g



850220
harmonie sable



850230
harmonie estivale



850225
harmonie naturelle



850235
harmonie délicate



OMBRE À PAUPIÈRES WATERPROOF

Une ombre à paupières waterproof à la texture ultra fondante. Sous forme de stylo, elle s'applique facilement et habille en délicatesse les paupières de teintes délicieuses. Pratique et astucieux, son taille-mine intégré permet un tracé toujours précis.

WATERPROOF EYE SHADOW

A waterproof eye shadow with a delightfully creamy texture. This pen eye shadow is easy to apply, delicately adding a touch of delightful colours to your eyelids. Practical and clever, it comes with a built-in sharpener to guarantee accurate application every time.

1,4 g



130180 - orchid



130181 - lilac



130183 - moss



130184 - feather



130188 - foam



130189 - seashell



130196 - black

| CRAYONS JUMBO / JUMBO EYELINER PENCILS



130154 - émeraude



130155 - laser



130158 - noisette



130159 - boudoir



130160 - noir



130161 - gris



130162 - brun



130163 - bleu



130164 - vert



130165 - prune

CRAYON YEUX JUMBO

Une formule ultra fondante et longue-tenue pour colorer les paupières ou intensifier le contour des yeux.

JUMBO EYELINER PENCIL

An instant-melt, long-lasting formula for colouring your eyelids or drawing attention to the area around the eyes.

1,6g



130166 - argent



130167 - or



130170 - pétrole



130171 - lila



130172 - mimosa



130173 - caramel



130174 - châtaigne



130175 - brownie



130176 - chocolat

| CRAYONS YEUX / EYELINER PENCILS

CRAYON YEUX WATERPROOF

Une formule waterproof crémeuse dans un crayon au format taillable ultra pratique. Indispensable pour souligner votre regard avec des couleurs intenses ! Formule khôl et kajal, elle s'applique en ras de cils ou à l'intérieur de l'œil.

WATERPROOF EYELINER PENCIL

A creamy waterproof formula in an ultra-practical pencil – simply sharpen to use! A must-have for highlighting your gaze with these intense colours! Available in both a kohl and kajal formula, for application outside the lash line or inside the lash line (tightlining).

1,25 g



131128 - bordeaux irisé



131129 - prune irisé



131130 - iris



131131 - marine irisé

NEW



131120 - noir



131121 - marron



131122 - beige



131123 - gris irisé



131124 - argenté



131125 - kaki irisé



131126 - mordoré



131127 - rose gold



131020 - noir



131021 - brun



131022 - bleu



131023 - vert



131024 - nuit

CRAYON YEUX WATERPROOF

Un crayon rétractable waterproof ultra précis qui souligne le contour de l'œil d'une couleur intense.

Le petit plus : un taille-mine intégré.

WATERPROOF EYELINER PENCIL

An ultra-precise retractable waterproof eyeliner pencil for adding a line of intense colour around your eyes.

Little extras: a blending tip to produce a smoky effect, plus a built-in mini-sharpener.

0,35 g



131025 - gris

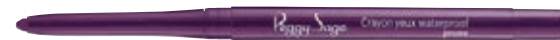

131026 - prune



131029 - émeraude



130198
curaçao

130201
noisette

130202
laser

130203
marine



130205
sapin



130207
ébène



130208
ardoise



130209
mauve



130210
émeraude



130211
havane



130212
blanc

CRAYON KHÔL YEUX

Des couleurs riches et une texture facile à travailler pour une application nette et précise.

KOHL EYELINER PENCIL

Rich colours and an easy-to-work texture for neat, accurate application.

1,14g

taille-crayon / pencil sharpener 130280/130283

CRAYON KHÔL ÉTOILÉ YEUX

Une texture douce et soyeuse pour un fini pailleté.

SPARKLING KOHL EYELINER PENCIL

A soft, silky texture for a glittery finish.

1,15g

taille-crayon / pencil sharpener 130280/130283



130305
noir



130307
brun

CRAYON KHÔL ORIENTAL YEUX

Un regard smoky et envoûtant grâce à cette texture douce, intensément noire et brillante.

ORIENTAL KOHL EYELINER PENCIL

A soft, intensely black, glossy texture for a bewitching, smoky gaze.

130320 - 1,13g - noir

taille-crayon / pencil sharpener 130280/130283



CRAYON KHÔL YEUX

5 teintes à la texture soyeuse pour un regard souligné et intensifié en un instant.

Ultra pratique : crayon et estompeur permettent une multitude d'effets.

KOHL EYELINER PENCIL

5 colours with a silky texture for a heightened, intensified gaze in an instant.

Ultra-practical: pencil and blending-in tool for a host of effects.

1,14g

taille-crayon / puntenslijper 130280/130283



131800
noir



131801
taupe



131802
prune



131803
vert jade



131804
bleu profond





EYELINER



NEW

EYELINER FEUTRE CHARISMA

Cet eyeliner hautement pigmenté vous offre une tenue longue durée jusqu'à 12h ! Résistant à l'eau, la formule sèche rapidement et ne coule pas. La mine feutre glisse facilement et vous permet un tracé net en un seul passage. A porter seul ou en combinant les couleurs.

CHARISMA FELT TIP EYELINER

This highly pigmented eyeliner gives you a long hold for up to 12 hours! The water-resistant formula dries quickly and does not run. The felt tip glides easily over your skin, creating a beautifully neat line in one go. Wear on its own or with a combination of colours.

1,1 ml



131925
noir



131926
brun intense mat



131927
taupe métallisé



131928
kaki mat



131929
bleu métallisé



131930
prune métallisé



131931
rose métallisé



131932
lagon métallisé

EYELINER CAKE

Une application nette et précise pour un regard éblouissant.

CAKE EYELINER

Neat, accurate application for a dazzling look.

130380 - 2 g - noir



EYELINER CRÈME LONGUE TENUE

Cet eyeliner longue tenue a une texture crème offrant précision et facilité d'application.

LONG-WEAR CREAM EYELINER

This long-wear eyeliner has a cream texture for precise, easy application.

130385 - 3,5 ml - noir

PINCEAU EYELINER

EYELINER BRUSH

135111 - 1 mm



EYELINER BLACKPEN WATERPROOF

Des yeux de chat d'un noir mat intense en un instant c'est possible !
Formule waterproof ! Il vous suivra dans tous vos challenges quotidiens sans couler !

BLACKPEN WATERPROOF EYELINER

Create a cat eye effect in an instant with this intense matte black eyeliner.
With its waterproof formula, it will accompany you through all your daily challenges without running.

131911 - noir

EYELINER SEMI-PERMANENT

Confort et longue tenue.

SEMI-PERMANENT EYELINER

Confort and long-lasting hold.

1,5 ml



131700
noir



131701
gris



131702
marron



EYELINER PINCEAU

Un applicateur pinceau pour un tracé net et précis.

BRUSH EYELINER

A brush applicator for a fine, accurate line.

2,5 ml



130361
noir

130366
prune

130367
nuit

130370
bronze

130372
pailleté noir

EYELINER ENCRIER

Un applicateur feutre pour souligner le regard et agrandir l'œil.

DIPLINER

A felt applicator for emphasizing your gaze and widening your eyes.

130410 - 3,8 ml - noir



EYELINER VINYL WATERPROOF

Une formule couvrante et waterproof pour des couleurs captivantes et ultra brillantes.

WATERPROOF VINYL EYELINER

A covering, waterproof formula for captivating and ultra-glossy colours.

2,5 ml



130550
noir

130551
brun

EYELINER ULTRA MAT WATERPROOF

Une formule intensément pigmentée, ultra mate et waterproof pour souligner le regard d'un trait précisément audacieux en un seul geste.

ULTRA-MATTE WATERPROOF EYELINER

An intensely pigmented ultra-matte waterproof formula that highlights your gaze with a bold, neat line in one go.

130570 - 2,5 ml - noir





| MASCARA



MASCARA LOVELY CILS LOVELY CILS MASCARA

Illusion faux cils. Des cils galbés d'un volume spectaculaire.
False eyelash illusion. Curved eyelashes with spectacular volume.

10 ml



130645
nuit

130648
havane



130649
océan

130650
noir



FABULOUS MASCARA

Un volume fabuleux en un clin d'œil.
If you're after enhanced volume and luscious curves, our Fabulous mascara is the way to go for spectacular lashes in one go.

130795 - 8,5 ml - noir



MASCARA DREAMY CILS DREAMY CILS MASCARA

Des cils allongés, étoffés et parfaitement séparés grâce à une brosse unique permettant une application précise et irréprochable.

A fast volumizing effect with no clumping – guaranteed! The unique brush design ensures precise, perfect application for longer, fuller and beautifully separated eyelashes.

130770 - 7 ml - noir

DEEP LOOK MASCARA

Volume et regard intensément noir garanti.
Great volume and an intensely dark gaze guaranteed!

130805 - 12,5 ml - noir



MASCARA SUBLICILS SUBLICILS MASCARA

Sa formule allonge les cils et les sépare un à un.
Its formula lengthens eyelashes and separates them individually.

130701 - 9 ml - noir



TEMPTING MASCARA

Un mascara multi-effet, volume, longueur et courbe, d'un noir profond. Il assure une charge maximale sur toute la longueur du cil en un seul geste.

A deep-black multi-effect mascara that increases volume, length and curve. For maximum coverage along the whole length of the eyelash in one go.

130796 - 9 ml - ultra noir



MASCARA XTREME CARE

Contient du Widelash™, activateur de croissance des cils.
With Widelash™, lash growth activator.

130806 - 11 ml - noir



MASCARA LOVELY CILS WATERPROOF LOVELY CILS WATERPROOF MASCARA

Un volume fabuleux et une tenue impeccable grâce à une nouvelle formule ultra gainante et parfaitement résistante à l'eau.

This mascara's new ultra clump-proof and incredibly water-resistant formula gives it amazing volume and an impeccable hold.

130651 - 9 ml - noir



TEMPTING MASCARA WATERPROOF WATERPROOF TEMPTING MASCARA

Volume, longueur et courbe dans une formule waterproof qui dépose sur les cils une couleur intense tout en résistant parfaitement à l'eau.

Volume, length and curve in a waterproof formula that adorns your eyelashes with intense and perfectly water-resistant colour.

130798 - 8 ml - noir



FAUX CILS / FALSE EYELASHES

FAUX CILS

Contient : 1 colle 1 g + 1 mode d'emploi

FALSE EYELASHES

Contains 1 glue 1 g and 1 instruction sheet.



130900
sophistication



130902
attraction



130931
regard charmeur



130932
regard coquin



130934
regard audacieux



130946
regard suave



130951
regard passionné



130953
regard captivant



130956
regard rêveur



130960
regard rayonnant



130961
regard époustoufflant



130968
superb



130969
wonderful



130970
gorgeous



130971
pretty



130972
splendid



130973
attractive



130964
regard fascinant



130965
regard ensorcelant



130966
regard envoûtant



130967
regard mystérieux



130984
legendary



130985
amazing



130986
sensational



130987
stunning



FAUX CILS PRÉCOLLÉS

Les faux cils s'utilisent sans colle et chaque boîte comprend une bande de colle supplémentaire. Ils pourront être utilisés jusqu'à 4 ou 5 fois de manière facile et efficace.

PRE-GLUED FALSE EYELASHES

No glue is required for these false eyelashes, and every box comes with an extra glue strip. They can be used easily and effectively up to 4 or 5 times.



130880
majestic



130882
glamour



130883
delicate



130884
whispering



130888
tender



130889
lofty



130890
charming



130891
lovely



130980
Morgane



130981
Audrey



130982
Amandine



130983
Justine

FAUX CILS MAGNÉTIQUES

Faux cils magnétiques à appliquer facilement, rapidement et sans colle !

Positionner la première frange de faux cils au ras de vos cils naturels.

Placer ensuite la seconde frange en dessous de vos cils naturels.

Les deux petits aimants présents sur chacune des deux franges vont bloquer entre eux vos cils naturels.

Pour les retirer, tirer la frange du haut vers le haut et la frange du bas vers le bas.

MAGNETIC FALSE EYELASHES

Magnetic false eyelashes that you can apply quickly, easily and without glue!

Place the first false eyelash fringe along the bottom of your natural lashes.

Next, place the second fringe underneath your natural lashes.

The two little magnets on the fringes will lock together on either side of your natural lashes.

To remove them, simply pull the top fringe upwards and the bottom fringe downwards.

90 FAUX CILS INDIVIDUELS PROFESSIONNELLS
90 PROFESSIONAL INDIVIDUAL FALSE EYELASHES



130906
 single bunch 7 - 9 - 11 mm
 30 par taille / 30 of each size



130910
 single bunch 9 mm

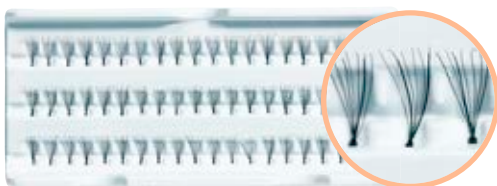

130911
 flare 13 mm

60 FAUX CILS INDIVIDUELS PROFESSIONNELLS
60 PROFESSIONAL INDIVIDUAL FALSE EYELASHES



130913
 flare 9 mm



130915
 flare 5 - 9 - 13 mm
 20 par taille / 20 of each size

COLLE FAUX CILS
FALSE EYELASHES GLUE

130920 - 7 g - De couleur blanche à la sortie du tube, elle devient transparente en séchant / white when it comes out of the tube, it turns transparent when it dries

130921 - 7 g - noir

130922 - 5 g - transparent / transparent



130920 - 7 g



130921 - 7 g



130922 - 5 g



MAQUILLAGE / MAKE-UP

LÈVRES / LIPS

Souligner votre sourire en sublimant vos lèvres d'un simple geste !

Peggy Sage embellit vos lèvres d'un voile de glamour incroyablement pigmenté. Découvrez de nombreuses textures avec nos crayons, rouge à lèvres et gloss aux finitions mates, irisées ou glossy. Sourire irrésistible et longue tenue garantis !

Bring out your smile by beautifying your lips at a stroke!

Peggy Sage enhances your lips with gorgeous colours containing stunning pigments. Check out the host of textures available in our lip pencils, lipsticks and lip glosses with matte, shimmer and gloss finishes. An irresistible smile and long hold guaranteed!

| CRAYONS LÈVRES / LIP PENCILS

CRAYON MINE LÈVRES LIP SHAPER

Le crayon mine Lip Shaper permet de tracer un contour des lèvres transparent et mat avant d'appliquer le rouge à lèvres pour que celui-ci ne file pas.

LIP SHAPER LIP LEAD PENCIL

The Lip Shaper lip lead pencil is used to draw a transparent, mat line around the lips before applying lipstick to prevent it from smudging.

133030 - 0,3g - transparent



130050 - nude



130051 - noisette



130052 - rose



130053 - rouge



CRAYON LÈVRES ULTRA LONGUE TENUE

Un crayon lèvres ultra longue tenue qui glisse facilement et se fixe instantanément sur les lèvres. Sans transfert, il assure un sourire parfaitement défini pendant de nombreuses heures.

ULTRA-LONG-WEAR LIP LINER

A lip liner with an extremely long-lasting hold that goes on easily and fixes to your lips instantly. This smudge-free lip liner guarantees a crisp, clear smile for hours.

1,20g



130054 - prune



130055 - violet



CRAYON CONTOUR DES LÈVRES

Nouvelle formule pour un contour des lèvres précis et bien dessiné pour éviter à votre rouge à lèvres de filer.

LIP LINER PENCIL

A new formula that draws a neat, accurate line around your lips to prevent your lipstick from smudging.

1,14g taille-crayon / pencil sharpener 130280/130283

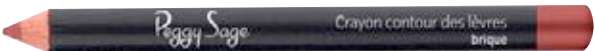

130101
brique



130104
cuivre



130105
lie de vin



130108
pétale



130109
rose



130110
violine



130111
prune



130112
chocolat



130113
moka



130114
rubis



130115
bois de rose



130116
marron glacé



131060 - rouge



131061 - brun



131062 - rose



131067 - chocolat



131068 - lie de vin



131069 - prune

CRAYON LÈVRES WATERPROOF

Un crayon rétractable waterproof ultra précis qui redessine et intensifie le contour des lèvres. Il peut également être appliqué sur la totalité de la bouche. Le petit plus : un taille-mine intégré.

WATERPROOF LIP LINER PENCIL

An ultra-precise retractable waterproof lip liner pencil for reshaping your lips and adding intense colour around the edge. It can also be applied to the rest of your lips. Little extras: a brush tip for blending in the line or applying as lipstick, plus a built-in mini-sharpener.

0,312 g



LIPLINER SEMI-PERMANENT

Confort et longue tenue.

SEMI-PERMANENT LIP LINER

Confort and long-lasting hold.

1,5 g



131600
bois de rose

131602
moka

131605
prune

131606
beige rose



130470 - stylish crush



130471 - loveable bloom



130473 - insatiable rose



130474 - forever carmin



130475 - twisted brown

CRAYON À LÈVRES

Le crayon à lèvres rétractable dépose un voile de couleur sur les lèvres avec une touche de brillance et de transparence. Sa texture légère et fondante permet une application sans effort et offre un confort unique et une tenue remarquable. Pratique, ce crayon à lèvres ne se taille pas.

LIP PENCIL

This retractable lip pencil gives your lips a subtle covering of colour, adding a touch of see-through glossiness. Its light, melt-in texture ensures effortless application for a unique feeling of comfort and a remarkable hold.

2 g



| ROUGES À LÈVRES / LIPSTICK



3,8g

ROUGE À LÈVRES

Une texture onctueuse, ultra confortable qui se décline en finition classique ou irisée.

LIPSTICK

An ultra-comfortable creamy texture with either a classic or shimmering finish.

3,8g

LES IRISÉS / SHIMMERING



110033
miel



110032
soie



110062
lady plum



110266
gipsy red



110034
abricot



110050
La Baule



110066
corail



110069
cuivre



110061
silky beige



110070
rose nacré



110076
rose égérie



110031
rose candy



110400
rose suprême



110268
marvellous pink



110450
rose délice



110285
Siam



110044
hibiscus



110022
diamant cerise

ROUGE À LÈVRES

Une texture onctueuse, ultra confortable qui se décline en finition classique ou irisée.

LIPSTICK

An ultra-comfortable creamy texture with either a classic or shimmering finish.

3,8g



LES MATS / MATTE



110075
precious nude



110038
rose boisé



110208
wild paradise



110402
noisette



110302
châtaigne mat



110081
moka



110023
St-Tropez



110460
rose cherry



110067
cassis



110058
grenat



110219
happy coral



110065
Moscou



110319
reddish lips



110216
red feelings



110008
Le Rouge



110214
dark red



110218
pink excess



110059
rose espiègle



110027
Valence



110026
cyclamen



110045
Montréal



110303
lie de vin



110053
bois de rose



110024
Biarritz



112501
nude mat

112502
framboise mat



112503
rouge mat

112507
lilas mat



112508
corail mat

112509
rose mat



ROUGE À LÈVRES MAT

Les rouges à lèvres mats de Peggy Sage offrent une texture crémeuse, à l'effet floutant, qui glisse sur les lèvres assurant un fini velouté, semi-mat, pour un confort absolu.

MATTE LIPSTICK

Peggy Sage semi-matte lipsticks have a creamy texture which creates a blurring effect, gliding onto your lips to create an oh-so-comfortable velvety, semi-matte finish.

2g



112513
fuchsia mat

112514
cerise mat

112515
griotte mat

112516
mûre mat

ROUGE À LÈVRES ULTRA MAT

Un rouge à lèvres longue tenue au fini vif, éclatant et parfaitement mat, enrichi en pigments haute couverture pour un look chic en toute simplicité.

ULTRA-MATTE LIPSTICK

The matte lipsticks grace your lips with intense, ultra-pigmented colour. Long-hold matte effect guaranteed. The ultra-slim stick is perfect for precise, controlled application.

2g



112621
subtle kiss

112622
delicate angel

112623
gentle embrace

112624
graceful smile

112625
nude beauty

112626
tender look



112601
natural pink

112604
red spirit

112605
crazy plum

112612
happy violine

112613
lovely prune

112616
flirty red



112648
Rio

112649
Boston

112650
Monaco

112651
Buenos Aires

112652
Madrid



116000
pink glossy



116002
brilliant peach



116004
crystal cheek



116006
copper shine



116008
light purple



116010
sparkling grape



116014
mauve glitter



116016
golden pink



116018
stylish mauve



116020
shiny rose

ROUGE À LÈVRES SHINY LIPS

Une texture glissante et ultra brillante pour ces rouges à lèvres effet glossy dont les couleurs transparentes illuminent les lèvres de mille éclats.

SHINY LIPS LIPSTICK

These glossy effect lipsticks have a fluid, ultra-glossy texture and come in transparent colours that brighten the lips with an attractive sheen.

3,8g



112640
that's peachy



112642
rose baby



112643
electric coral



112644
coquelicot



112645
velours pourpre



POUDRE À LÈVRES ULTRA MATE POMPON

Adopter la tendance poudrée et parer vos lèvres d'une couleur intensément mate. Appliquer votre poudre à lèvres ultra mate grâce au pompon en mousse intégré. Cette texture permet de jouer sur les volumes en appliquant votre poudre de manière opaque ou ombrée!

ULTRA-MATTE SOFT-TIP LIP POWDER

Join the latest powder trend and beautify your lips with these intensely matte colours. Apply your ultra-matte lip powder using the built-in soft foam tip. Use the powder texture to create different volume effects by applying your powder opaquely or in shades!

0,8g



117409
Hollywood fame



117410
Sydney star



117411
trendy Paris



117412
soft linen



117413
orchid show



117414
Mauritius rule



117417
fraise



117418
framboise



117419
young fashion



117420
love drama



117421
comedy time



117422
choose joy



117423
hiberdating



117424
limitless

ROUGE À LÈVRES LIQUIDE STAY MATTE

Formule longue tenue, opaque et crémeuse qui glisse sur les lèvres et les laisse intensément mates et colorées.

STAY MATTE LIQUID LIPSTICK

An opaque, creamy long-wear formula that glides on to your lips and leaves them intensely matte and coloured.

6 ml

PALETTE ROUGES À LÈVRES

Une harmonie de tons froids et une harmonie de tons chauds à la texture douce et soyeuse.

LIPSTICK PALETTE

A matching set of cold tones and a matching set of warm tones with a soft, silky texture.

114101 - 5 x 1,5g
tons froids / cold tones

114102 - 5 x 1,5g
tons chauds / warm tones

114101

114102

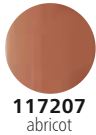

117207
abricot

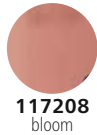

117208
bloom

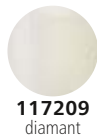

117209
diamant



GLOSS À LÈVRES MILKY SHINE

Milky shine apporte à votre bouche un effet volume immédiat et une teinte subtile. Sa texture crémeuse délicatement parfumée à la mûre rendra son application délicieuse.

MILKY SHINE LIP GLOSS

Milky Shine has an immediate volumizing effect, adding subtle colour to your lips. Its delicately blackberry-perfumed creamy texture makes application a delicious treat.

3 ml

FIXATEUR DE ROUGE À LÈVRES

Incolore, il s'applique après le rouge à lèvres et prolonge sa tenue sans provoquer d'inconfort.

LIPSTICK FIXATIVE

This colourless fixative is applied on top of lipstick to prolong its hold without causing discomfort.

804050 - 5 ml





MAQUILLAGE / MAKE-UP

ACCESSOIRES / ACCESSORIES

Les indispensables qui accompagneront toutes vos mises en beauté !

Pinceaux, éponges, recourbe-cils ... L'application des produits est facilitée grâce à notre sélection d'accessoires qui s'adaptent à votre technique. Une envie particulière ? Nos produits sont déclinés en plusieurs versions pour un travail précis et un résultat professionnel !

The essentials for every beauty makeover!

Brushes, sponges, lash curlers and more... Our selection of accessories makes product application child's play, with something for every technique. Looking for something in particular? Our products are available in several versions for precision work and professional results!

| PINCEAUX / BRUSHES

NEW

**PINCEAU POUDRE
POWDER BRUSH**



135215 - nylon

**PINCEAU BLUSH
BLUSH BRUSH**



135216 - nylon

**PINCEAU FOND DE TEINT
FOUNDATION BRUSH**



135217 - nylon

**PINCEAU ANTI-CERNES
DARK CIRCLE CONCEALER BRUSH**



135218 - nylon

**PINCEAU BOULE
ROUND-TIP BRUSH**



135219 - nylon

**PINCEAU ESTOMPEUR
BLENDING BRUSH**



135220 - nylon

**PINCEAU À PAUPIÈRES
EYE SHADOW BRUSH**



135221 - nylon

**PINCEAU OBLIQUE YEUX
OBLIQUE BRUSH FOR EYES**



135222 - nylon

**PINCEAU EYELINER
EYELINER BRUSH**



135223 - nylon

**GOUPILLON CILS
RIFLE-TYPE EYELASH BRUSH**



135224 - nylon

**PINCEAU CILS & SOURCILS
EYELASH AND EYEBROW BRUSH**



135225 - nylon

**PINCEAU LÈVRES
LIP BRUSH**



135226 - nylon

NEW



SET DE 12 PINCEAUX MAQUILLAGE

Set de 12 pinceaux professionnels de maquillage avec rabat de protection afin de ne pas abîmer le poil des pinceaux.

SET OF 12 MAKE-UP BRUSHES

Set of 12 professional make-up brushes with protective hood to avoid bristle damage. With this set you can take with you all the make-up brushes a professional needs.

135228 - 22 x 14,5 x 4 cm

O'BRUSH - PINCEAUX MAKE-UP BROSSSE

Une innovation dans la sphère du make-up, les pinceaux brosse sont devenus des incontournables. Les O'brush de Peggy Sage ont une répartition de poils unique.

Ils sont denses, résistants et surtout d'une extrême douceur.

Les O'brush vous permettront d'appliquer vos produits de maquillage de manière fluide et rapide pour un résultat optimal.

O'BRUSH FOUNDATION BRUSH

The latest exciting make-up innovation, superfine brushes, are now a must-have! The Peggy Sage O'brush range features a unique bristle distribution design. They are dense, hard-wearing and above all oh-so soft. With an O'brush you can apply your make-up incredibly smoothly and quickly, for perfect results.

135172 - fond de teint / foundation - L 40 mm - Nylon

135173 - fond de teint / foundation - M 35 mm - Nylon

135174 - fond de teint / foundation - blush - contouring - S 30 mm - nylon

135175 - anti-cernes / concealer - contouring - XS 20 mm - nylon



135172



135173



135174



135175



SET DE 4 PINCEAUX MAKE-UP O'BRUSH + 2 PINCEAUX ET UNE TROUSSE OFFERTS

Set composé de 6 pinceaux à maquillage pour les yeux, les lèvres, les joues.

SET OF 4 O'BRUSH MAKE-UP BRUSHES + 2 FREE BRUSHES AND CASE

Set of 6 make-up brushes for eyes, lips, cheeks.

135171 - nylon

**PINCEAU À PAUPIÈRES
EYE SHADOW BRUSH**

135186 - 10 mm - nylon



135186

EASY TO USE FLAT-TIPPED BRUSH - CONTOURING & BLUSH

Le partenaire idéal pour un effet bonne mine réussi !
Il s'utilise avec vos poudres de teint classiques.

BLUSH BRUSH

Your perfect partner for a winning healthy glow!
Can be used with your standard powder blushes.

135187 - 18 mm - nylon



135187

**PINCEAU FOND DE TEINT
FOUNDATION BRUSH**

135188 - 20 mm - nylon



135188

**PINCEAU POUDRE
POWDER BRUSH**

135189 - 20 mm - nylon



135189

NEW



NEW

SET DE 4 PINCEAUX MAKE-UP + TROUSSE

Set composé de 4 pinceaux à maquillage pour les yeux, les lèvres, les joues.

SET OF 4 MAKE-UP BRUSHES + POUCH

Set of 4 make-up brushes for eyes, lips, cheeks.

135229 - 21 x 12 x 1,5 mm - nylon

SET DE 4 PINCEAUX MAKE-UP

Set composé de 4 pinceaux à maquillage pour les yeux, les lèvres, les joues.

SET OF 4 MAKE-UP BRUSHES

Set of 4 make-up brushes for eyes, lips, cheeks.

135514 - nylon





**PINCEAU FOND DE TEINT
FOUNDATION BRUSH**

135116 - 20 mm - nylon

**PINCEAU FOND DE TEINT
FOUNDATION BRUSH**

135148 - 20 mm - nylon



**PINCEAU ANTI-CERNES
DARK CIRCLE CONCEALER BRUSH**

135132 - 6 mm - nylon



135131

**PINCEAU POUDRE
POWDER BRUSH**

Nylon.

135131 - 20 mm

135100 - 22 mm

135101 - 25 mm



135100



135101

**PINCEAU POUR JOUES ET POUDRE
CHEEKBONES AND POWDER BRUSH**

135119 - 20 mm - nylon



135202 - 30 mm - nylon
PINCEAU POUDRE KABUKI
KABUKI POWDER BRUSH
135203 - 40 mm - nylon



135202



135203



PINCEAU BLUSH
BLUSHERKWAST
135102 - 20 mm - nylon

PINCEAU BLUSH RÉTRACTABLE
RETRACTABLE BLUSH BRUSH
135200 - 25 mm - nylon



PINCEAU ÉVENTAIL
FAN BRUSH
135103 - 20 mm - nylon

PINCEAU OBLIQUE POUR POMMETTES
OBLIQUE BRUSH FOR CHEEKBONES
135113 - 24 mm - nylon





135107 - 10 mm



135106 - 12 mm



135134 - 12 mm



135105 - 14 mm

**PINCEAU À PAUPIÈRES
EYE SHADOW BRUSH**

Nylon.

135107 - 10 mm

135106 - 12 mm

135134 - 12 mm

135105 - 14 mm

**PINCEAU À PAUPIÈRES
EYE SHADOW BRUSH**

Nylon.

135124 - 7 mm

135125 - 10 mm

135126 - 12 mm



135124



135125



135126

**PINCEAU À PAUPIÈRES BISEAUTÉ
TAPERED EYE SHADOW BRUSH**

135128 - 7 mm - nylon



**PINCEAU OMBREUR BISEAUTÉ
TAPERED EYE SHADOW BRUSH**

135141 - 9 mm - nylon



135143

**PINCEAU OBLIQUE POUR LES YEUX
OBLIQUE BRUSH FOR EYES**

135143 - 8 mm - nylon

135144 - 9 mm - nylon



135144

PINCEAU OBLIQUE POUR LES YEUX
OBLIQUE BRUSH FOR EYES

135114 - 5 mm - nylon



PINCEAU ESTOMPEUR POIL COURT
SHORT-BRISTLED BLENDING BRUSH

135142 - 10 mm - nylon



PINCEAU ESTOMPEUR
BLENDING BRUSH

135146 - 9 mm - nylon

135147 - 9 mm - nylon



PINCEAU BOULE
ROUND-TIP BRUSH

135140 - 7 mm - nylon



PINCEAU POUR LES YEUX EN SILICONE

Les pinceaux en silicone permettent de travailler toutes les matières d'ombres à paupières qu'elles soient poudrées, pailletées ou ultra crémeuses. La tête en silicone est facile à nettoyer et à sécher pour une hygiène irréprochable.

SILICONE EYE SHADOW BRUSH

Silicone brushes are perfect for applying every kind of eye shadow: powder, glitter and even ultra-cream ones. The silicone head is easy to clean and dry, for faultless hygiene.

135135 - paupières / oogschaduw

135136 - eyeliner





120160 - double
x2 - 6,5 cm



120161 - double
x2 - 5 cm



120162 - simple
x2 - 3,5 cm

**APPLICATEUR MOUSSE X2
FOAM APPLICATOR**

**APPLICATEUR MOUSSE + 3 EMBOUTS
FOAM APPLICATOR BRUSH + 3 FERRULES
135109 - 8mm**



**PINCEAU EYELINER
EYELINER BRUSH
135120 - 2 mm - nylon**

**GOUPILLON CILS
RIFLE-TYPE EYELASH BRUSH
135108 - nylon**



**PINCEAU PEIGNE CILS ET SOURCILS
EYELASH AND EYEBROW BRUSH
135130 - 25 mm - nylon**

135122 - 5 mm - nylon

**PINCEAU À LÈVRES
LIP BRUSH**

135123 - 4 mm - nylon



135122 - 5 mm



135123 - 4 mm



**PINCEAU À LÈVRES
LIP BRUSH**

135110 - 7 mm - nylon

**PINCEAU LÈVRES RÉTRACTABLE
RETRACTABLE LIP BRUSH**

135145 - 4 mm - nylon



NETTOYANT PINCEAUX À MAQUILLAGE

Nettoie et protège le poil des pinceaux. Il permet de conserver les pinceaux plus longtemps et de préserver leur souplesse.

MAKE-UP BRUSH CLEANER

Cleanses and protects the brush bristles. Enables brushes to last longer and keeps the bristles soft.

135150 - 200 ml



**TABLIER PINCEAUX
MAKE-UP BRUSH BELT**

135401 - 39,5 x 32,5 cm - livré vide / supplied empty

POCHETTE POUR 12 PINCEAUX MAQUILLAGE

Une pochette ultra pratique et élégante pour ranger les pinceaux de maquillage.

EMPTY CASE FOR 12 MAKE-UP BRUSHES

A really handy and elegant case to keep your make-up brushes in.

135302 - fermée / closed : 20 x 12 cm / ouverte / open : 20 x 36 cm
livrée vide / supplied empty



BROSSE NETTOYANTE SILICONE POUR PINCEAUX

Apporter à vos pinceaux le soin qu'ils méritent grâce à cette ventouse nettoyante en silicone. Les picots de formes variables vous permettent de nettoyer tous types de pinceaux. À utiliser avec un nettoyant pinceau ou à sec pendant le maquillage afin d'enlever l'excédent de matière ou simplement entre deux couleurs différentes.

SILICONE BRUSH CLEANER

Treat your brushes with the care they deserve with this silicone suction cup brush cleaner. The different textured areas make it suitable for cleaning all types of brushes. You can use it with a cleaning fluid, or dry when applying make-up to remove excess material, or simply between applications of different colours.

135338

EPONGE NETTOYANTE PINCEAUX CLEAN COLOR SWITCH

L'éponge nettoyante Clean Color Switch est le secret pour des pinceaux propres en quelques secondes. Elle permet de retirer, quasi instantanément, tous types de poudres des pinceaux, entre différentes applications, sans avoir à utiliser de solution liquide. Pour cela, il suffit de balayer le pinceau sur l'éponge en effectuant des mouvements circulaires pour enlever les pigments de couleurs.

CLEAN COLOR SWITCH BRUSH-CLEANING SPONGE

The Clean Color Switch brush-cleaning sponge is the secret to clean brushes in seconds. It almost instantly removes all types of powders from your brushes between applications, with no liquid solution required. To remove the colour pigments from your brush, simply brush the bristles over the sponge with a circular motion.

135340 - Ø 5,5 cm

135341 - présentoir / display
contient 20 pièces / contains 20 pieces
30,5 x 27 x 21,7 cm



ARBRE SÈCHE PINCEAUX

Après le nettoyage, optimiser le séchage de vos pinceaux à maquillage tout en conservant leur forme d'origine grâce à cet arbre sèche pinceaux. Son format pratique et réversible permet de positionner et maintenir facilement 12 pinceaux tête en bas.

BRUSH-DRYING RACK

Using this brush-drying rack after cleaning will ensure your make-up brushes dry properly while retaining their original shape. With its practical, reversible design, it can easily hold 12 brushes with their bristles pointing downwards.

135339

| AUTRES ACCESSOIRES / OTHER ACCESSORIES



**ÉPONGE PEELING
EXFOLIATING SPONGE**
120182 - 10 x 7 cm



BLENDER SILICONE
Pour texture crémeuse.
SILICONE BLENDER
For creamy textures.
120208



120145



120186 - x2

**ÉPONGE MAQUILLAGE
MAKE-UP SPONGE**

120145
7,5 x 4 cm

120186
x 2 - 9 x 3,5 cm

120195
x 50 - 5,5 x 2,5 cm

120195 - x50



120192 - x 2 - Ø 7 cm

**ÉPONGE CELLULOSE
CELLULOSE SPONGE**
120199 - x 25 - Ø 7 cm



120192
x2



120199
x25

ÉPONGE À DÉMAQUILLER
CLEANSING SPONGE
120187 - 11 x 8 cm

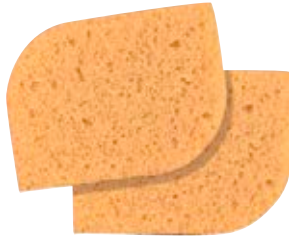

ÉPONGE NATURELLE À DÉMAQUILLER
NATURAL CLEANSING SPONGE
120184 - x 2 - 5,3 x 8 cm

GANT DÉMAQUILLANT RÉUTILISABLE

Pour un démaquillage délicat mais efficace, optez pour ce gant démaquillant réutilisable et lavable en machine. En microfibre 100% polyester, ce gant retire tous types de maquillage, même waterproof. Il suffit d'insérer votre main à l'intérieur, de le passer sous l'eau et de le frotter doucement sur le visage.

REUSABLE MAKE-UP REMOVER GLOVE

For gentle but effective make-up removal, use this machine-washable reusable make-up remover glove. Made of 100% polyester microfibre, this glove removes all kinds of make-up, even waterproof products. Simply insert your hand into the glove, run it under the tap and rub it gently over your face.

120209 - 12 x 10,5 cm





120193
x25 - 6 x 4 cm

ÉPONGES MAQUILLAGE MAKE-UP SPONGES

Latex.



120180
x6 - 3,2 x 3,5 cm



120169
x2 - 6 x 4 cm



120197
x50 - 3,2 x 3,5 cm



120196
x25 - 7 x 5 cm



120174
x2 - 7 x 5 cm



120181
x4 - 5,5 x 2 cm



120167
x2 - 7,5 x 5 cm



120170
x2 - Ø 5,5 cm



120171
x2 - 4 x 5,5 cm



120172
x2 - 5 x 5,5 cm



120173
x2 - 5 x 6 cm



120148
x2 - Ø 5 cm

**HOUPPETES
POWDERPUFF**



120176
x2 - Ø 6 cm



120177
Ø 7,5 cm



120188
Ø 9 cm



120194
x25 - Ø 6,5 cm



120158
x2 - Ø 5 cm



RECORBE-CILS

Ce recourbe cils assure une courbure parfaite des cils et dessine le regard, le tout avec une prise en main ergonomique.

EYELASH CURLER

This easy-to-hold ergonomic eyelash curler gives your eyelashes the perfect curve and adds structure to your gaze.

135501

RECHARGE RECORBE-CILS

Les coussinets de recharge assurent des cils parfaitement courbés à chaque utilisation du recourbe-cils.

EYELASH CURLER REFILL PADS

These refill pads ensure your eyelashes form a perfect curve every time you use the eyelash curler.

135502 - x5



TIRE COMÉDONS PROFESSIONNEL

1 boucle fine, 1 boucle plate.

PROFESSIONAL COMEDO EXTRACTOR

1 fine loop, 1 flat loop.

300030

CISEAUX POILS DU NEZ
NOSE HAIR SCISSORS
300011 - 11cm



CISEAUX MOUSTACHES
MOUSTACHE SCISSORS
300012 - 11cm



130280



130282

TAILLE-CRAYON
PENCIL SHARPENER
130280 **130282**



130283



130285

130283 **130285** - 16 mm

PINCE À ÉPILER PROFESSIONNELLE SOUPLE

Acier inoxydable.

PROFESSIONAL FLEXIBLE TWEEZERS

Stainless-steel.

300040 - 9 cm - mors biais / offset grip

300041 - 9 cm - mors carrés / square grip



300040



300041



300042 - inox



300043 - rose



300045 - blanc

PINCE À ÉPILER PROFESSIONNELLE

9,5 cm - acier inoxydable, mors biais, rectifiés, souples.

PROFESSIONAL TWEEZERS

9,5 cm - stainless-steel, offset, rectified, flexible grip.



300044 - vert



300046 - noir

PINCE À ÉPILER STRASS

Acier inoxydable, mors biais, rectifiés, souples.

RHINESTONE TWEEZERS

Stainless steel, offset, rectified, flexible grip.

300085 - 9,5 cm - noir

300086 - 9,5 cm - rose

300087 - 9,5 cm - argent



300085



300086



300087

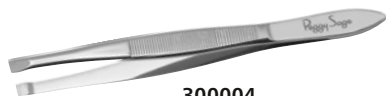

300004

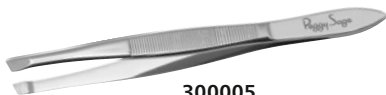

300005



300006

PINCE À ÉPILER PROFESSIONNELLE

Acier inoxydable.

PROFESSIONAL TWEEZERS

Stainless-steel.

300004 - 9 cm - acier inoxydable, mors carrés, rectifiés, souples
stainless-steel, square, rectified, flexible grip

300005 - 9 cm - acier inoxydable, mors biais, rectifiés, souples
stainless-steel, offset, rectified, flexible grip

300006 - 9 cm - chromée, mors crabes, rectifiés, souples
chrome-plated, crab-claw, rectified, flexible

MIROIR DOUBLE FACE GROSSISSANT X1/X5

Sa face grossissante jusqu'à 5 fois offre un confort d'utilisation optimal et de précision.

DOUBLE-SIDED 5X MAGNIFYING MIRROR

Its 5-times magnifying side is extremely handy for precision work.

155230 - ø 15 cm / 11 x 18 cm
pied pivotant / acrylique
pivoting stand / acrylic

155231 - ø 15 cm / 13 x 25 cm
tête pivotante / finition chromée
pivoting head / chrome finish



155230



155231



MIROIR LUMINEUX GROSSISSANT X5

Sa face à LED grossissante jusqu'à 5 fois offre un confort d'utilisation optimal et de précision tout en éclairant le visage et le cou.

ILLUMINATED 5X MAGNIFYING MIRROR WITH STAND

With its LED light, this up-to-5-times magnifying mirror illuminates your face and neck, making it extremely handy for precision work.

Éclairage LED - Finition chromée / LED light - Chrome finish

Fonctionne avec 4 piles 1,5V AA LR6 (non livrées) / Operates with 4 x 1.5V AA batteries (not supplied)

155232 - ø 20 cm / 14 x 33 cm

MIROIR DOUBLE FACE GROSSISSANT X10

Miroir recto verso sur pied, idéal pour le maquillage et tout autre soin du quotidien. Sa face grossissante jusqu'à 10 fois offre un confort d'utilisation optimal et de précision. Tête pivotante, finition chromée.

DOUBLE-SIDED 10X MAGNIFYING MIRROR WITH STAND

This double-sided mirror on a stand is perfect for make-up application and any other daily care routine. Its 10-times magnifying side is extremely handy for precision work. Pivoting head, chrome finish.

155233 - ø 15 cm / 13 x 25 cm





MAQUILLAGE / MAKE-UP

EMBELLISSEMENT DU REGARD / GAZE ENHANCEMENT

L'expertise professionnelle pour un regard naturellement embellit.

Peggy Sage vous propose plusieurs techniques professionnelles afin de sublimer le regard : extension de cils, rehaussement de cils et teinture de cils et sourcils. Une gamme complète de produits de qualité a été développée spécialement par des professionnels pour les professionnels.

Professional expertise for a more beautiful gaze - naturally.

Peggy Sage offers several professional techniques for enhancing your gaze: lash extensions, lash lifting and lash and brow tinting. A complete range of quality products developed by professionals for professionals.

| EXTENSIONS DE CILS / EYELASH EXTENSIONS

CIL À CIL / LASH TO LASH

CILS DE SOIE PROFESSIONNELS POUR POSE D'EXTENSIONS

Brillance absolue, légèreté incomparable, souplesse remarquable, aspect naturel.
Longue tenue (jusqu'à 4 semaines).

Boîte contenant 12 rangées de cils :
1 courbure x 1 épaisseur x longueurs multiples.

PROFESSIONAL SILK LASHES FOR EYELASH EXTENSIONS

Ultra-glossy, amazingly light, remarkably soft, natural-looking.

Long hold (up to 4 weeks).

Box containing 12 rows of eyelashes:

1 curve x 1 thickness x several lengths.

Cils J : courbure naturelle / J lashes: natural curve.

Cils C : courbure extrême / C lashes: extreme curve.

Cils D : courbure extravagante / D lashes: extravagant curve.

3 thickness / 3 diktes (0,15 - 0,20 - 0,25 mm).

Several lengths / Diverse lengtes (7 - 9 - 11 - 13 - 15 mm).



0,15 mm

137040 - 7, 9, 11, 13, 15 mm
137134 - 7, 8, 9, 10, 11 mm
137143 - 11, 12, 13, 14, 15 mm
137152 - 8, 9, 10, 11, 12 mm
137162 - 7, 8, 9, 10, 11, 12, 13, 14, 15 mm
137035 - 8, 10, 12, 14, 16 mm



0,20 mm

137041 - 7, 9, 11, 13, 15 mm
137135 - 7, 8, 9, 10, 11 mm
137144 - 11, 12, 13, 14, 15 mm
137153 - 8, 9, 10, 11, 12 mm
137163 - 7, 8, 9, 10, 11, 12, 13, 14, 15 mm
137034 - 8, 10, 12, 14, 16 mm



0,25 mm

137046 - 7, 9, 11, 13, 15 mm
137136 - 7, 8, 9, 10, 11 mm
137145 - 11, 12, 13, 14, 15 mm
137154 - 8, 9, 10, 11, 12 mm
137164 - 7, 8, 9, 10, 11, 12, 13, 14, 15 mm
137033 - 8, 10, 12, 14, 16 mm



0,15 mm

137042 - 7, 9, 11, 13, 15 mm
137131 - 7, 8, 9, 10, 11 mm
137140 - 11, 12, 13, 14, 15 mm
137149 - 8, 9, 10, 11, 12 mm
137159 - 7, 8, 9, 10, 11, 12, 13, 14, 15 mm
137038 - 8, 10, 12, 14, 16 mm



0,20 mm

137043 - 7, 9, 11, 13, 15 mm
137132 - 7, 8, 9, 10, 11 mm
137141 - 11, 12, 13, 14, 15 mm
137150 - 8, 9, 10, 11, 12 mm
137160 - 7, 8, 9, 10, 11, 12, 13, 14, 15 mm
137037 - 8, 10, 12, 14, 16 mm



0,25 mm

137047 - 7, 9, 11, 13, 15 mm
137133 - 7, 8, 9, 10, 11 mm
137142 - 11, 12, 13, 14, 15 mm
137151 - 8, 9, 10, 11, 12 mm
137161 - 7, 8, 9, 10, 11, 12, 13, 14, 15 mm
137036 - 8, 10, 12, 14, 16 mm



0,15 mm

137044 - 7, 9, 11, 13, 15 mm
137137 - 7, 8, 9, 10, 11 mm
137146 - 11, 12, 13, 14, 15 mm
137155 - 8, 9, 10, 11, 12 mm
137165 - 7, 8, 9, 10, 11, 12, 13, 14, 15 mm
137032 - 8, 10, 12, 14, 16 mm



0,20 mm

137045 - 7, 9, 11, 13, 15 mm
137138 - 7, 8, 9, 10, 11 mm
137147 - 11, 12, 13, 14, 15 mm
137156 - 8, 9, 10, 11, 12 mm
137166 - 7, 8, 9, 10, 11, 12, 13, 14, 15 mm
137031 - 8, 10, 12, 14, 16 mm



0,25 mm

137039 - 7, 9, 11, 13, 15 mm
137139 - 7, 8, 9, 10, 11 mm
137148 - 11, 12, 13, 14, 15 mm
137158 - 8, 9, 10, 11, 12 mm
137167 - 7, 8, 9, 10, 11, 12, 13, 14, 15 mm
137030 - 8, 10, 12, 14, 16 mm

VOLUME Russe / Russian Volume Lashes

CILS DE SOIE PROFESSIONNELS 3D, 4D, 5D ET 6D POUR POSE D'EXTENSIONS

Brillance absolue, légèreté incomparable, souplesse remarquable, aspect naturel.

Longue tenue (jusqu'à 4 semaines).

Boîte contenant 6 rangées de 44 cils :

1 courbure x 1 épaisseur x longueurs multiples.

PROFESSIONAL SILK LASHES 3D, 4D, 5D ET 6D FOR EYELASH EXTENSIONS

Ultra-glossy, amazingly light, remarkably soft, natural-looking.

Long hold (up to 4 weeks).

Box containing 6 rows of 44 eyelashes:

1 curve x 1 thickness x several lengths.

Cils J: courbure naturelle / J lashes: natural curve.

Cils C: courbure extrême / C lashes: extreme curve.

3 épaisseurs / 3 diktes (0,15 - 0,20 - 0,25 mm).

Longueurs multiples / Diverse lengte (7 - 9 - 11 - 13 - 15 mm).

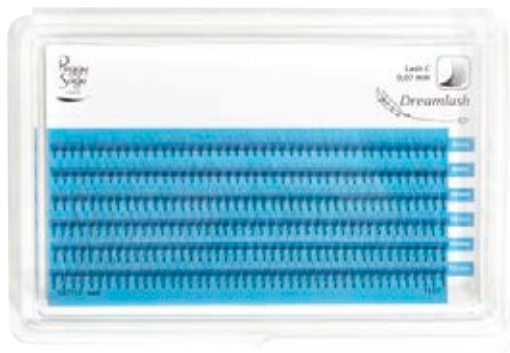

3D



0,07 mm

137064 - 7, 9, 11 mm

137062 - 8, 10, 12 mm

0,10 mm

137067 - 7, 9, 11 mm

137063 - 8, 10, 12 mm

4D



0,07 mm

137071 - 7, 9, 11 mm

137068 - 8, 10, 12 mm

0,10 mm

137072 - 7, 9, 11 mm

137069 - 8, 10, 12 mm

5D



0,07 mm

137076 - 7, 9, 11 mm

137073 - 8, 10, 12 mm

0,10 mm

137077 - 7, 9, 11 mm

137074 - 8, 10, 12 mm

6D



0,07 mm

137085 - 7, 9, 11 mm

137078 - 8, 10, 12 mm

0,10 mm

137086 - 7, 9, 11 mm

137079 - 8, 10, 12 mm



0,07 mm

137089 - 7, 9, 11 mm

137087 - 8, 10, 12 mm

0,10 mm

137127 - 7, 9, 11 mm

137088 - 8, 10, 12 mm



0,07 mm

137095 - 7, 9, 11 mm

137093 - 8, 10, 12 mm

0,10 mm

137096 - 7, 9, 11 mm

137094 - 8, 10, 12 mm



0,07 mm

137115 - 7, 9, 11 mm

137097 - 8, 10, 12 mm

0,10 mm

137116 - 7, 9, 11 mm

137098 - 8, 10, 12 mm



0,07 mm

137119 - 7, 9, 11 mm

137117 - 8, 10, 12 mm

0,10 mm

137126 - 7, 9, 11 mm

137118 - 8, 10, 12 mm

COLLE EXTENSIONS DE CILS EYELASH EXTENSIONS GLUE

137168 - 5g - noir / black

137169 - 5g - noir / black
séchage rapide / ultra-quick-drying

137050 - 10g - noir / black

137052 - 10g - noir / black
séchage rapide / ultra-quick-drying



137050 - 10g

137168 - 5g

137052 - 10g

137169 - 5g



TOP COAT EXTENSIONS DE CILS ET SOURCILS

Un top coat à appliquer après chaque pose d'extensions de cils et de sourcils afin d'illuminer, de protéger et de prolonger la tenue des extensions.

EYELASH AND EYEBROW EXTENSIONS TOP COAT

Apply this top coat after every application of eyelash and eyebrow extensions to brighten, protect and prolong the hold of the extensions.

137054 - 10g

SÉRUM DE SOIN CILS ET SOURCILS

Spécialement formulé pour accélérer la croissance naturelle des cils et des sourcils.

Il peut être utilisé seul mais aussi par-dessus les extensions de cils et de sourcils. Il est recommandé d'appliquer le sérum 2 fois par jour à la base des cils et des sourcils.

EYELASH AND EYEBROW CARE SERUM

A care serum specially formulated to accelerate the natural growth of eyelashes and eyebrows. It can be used both on its own and on eyelash and eyebrow extensions. For best results, apply the serum twice a day to the base of the eyelashes and eyebrows.

137058 - 10g



MASCARA EXTENSIONS DE CILS

Un mascara doux et soyeux, enrichi en gelée royale, spécialement conçu pour ne pas endommager la colle sur les extensions de cils. À base d'eau, il se retire très facilement à l'eau.

EYELASH EXTENSION MASCARA

A gentle, silky mascara enriched with royal jelly, specially formulated not to damage eyelash extension glue. This water-based mascara contains no fat and comes off easily with water.

137057 - 8g - noir / Schwarz



SHAMPOING CILS

Contenant de la kératine et la provitamine B5, le shampooing pour les yeux retire efficacement, et en douceur, chaque trace de maquillage, tout en apportant un soin précieux aux cils. Il permet d'avoir une surface propre et non grasse pour une meilleure adhérence de la colle.

LASH SHAMPOO

Containing keratin and provitamin B5, this eye shampoo gently but effectively removes all traces of make-up while giving your eyelashes some much-needed care. It creates a clean, non-greasy surface for improved glue adherence.

137190 - 70 ml

PINCEAU - SHAMPOING CILS

En poils synthétiques et particulièrement doux, le pinceau est parfaitement adapté à l'application du shampooing cils.

BRUSH FOR LASH SHAMPOO

This brush with very soft synthetic bristles is perfect for applying eye shampoo.

137191

DISQUE DÉMAQUILLANT EXTENSIONS DE CILS

Les disques démaquillants retirent efficacement le maquillage, mais aussi les impuretés présentes sur le contour des yeux, sans pelucher. Ils sont fins, et pré-imbibés d'un soin nettoyant enrichi à l'eau de rose n'irritant pas les yeux. Ils permettent d'avoir une surface propre et non grasse pour une meilleure adhérence de la colle. Appliqués, également, en démaquillant quotidien, il prolonge la durée de vie des extensions de cils, du réhaussement de cils et de la teinture cils et sourcils.

EYELASH EXTENSION REMOVAL DISCS

These lint-free removal discs are effective in removing not only make-up but also impurities from the eye contour area. The slim discs are pre-moistened with a cleansing lotion enriched with rose water that does not irritate the eyes. They create a clean, non-greasy surface for improved glue adherence. When used for daily lash cleansing, they prolong the life of eyelash extensions, lash lifts and lash and brow tints.

137056 - 75 disques / removal discs x 75



PRIMER EXTENSIONS DE CILS À L'EAU DE ROSE

Le primer dégraisse et nettoie cils et sourcils tout en optimisant l'adhérence de la colle. Enrichie à l'eau de rose, il n'irrite pas les yeux.

EYELASH EXTENSIONS PRIMER WITH ROSE WATER

This primer degreases and cleanses eyelashes and eyelids while optimising glue adherence. It is enriched with rose water and does not irritate the eyes.

137061 - 50ml

PATCH GEL CONTOUR DES YEUX 5 X 2

Les patchs gel protègent la paupière inférieure et isolent les cils lors d'une prestation d'extensions de cils, d'un réhaussement de cils ou d'une teinture de cils et/ou sourcils. Enrichis en coenzyme Q10, huile de ricin et extrait de feuilles d'aloë, ils apportent fraîcheur et éclat au contour de l'œil.

EYE CONTOUR GEL PATCH, 2 X 5

These gel patches protect the lower eyelid and separate the lashes when applying eyelash extensions and providing lash lifts and lash and brow tints. Enriched with coenzyme Q10, castor oil and aloe leaf extract, they leave the eye contour area fresh and radiant.

137055 - contient 5 paires / contains 5 pairs



RUBAN ADHÉSIF MÉDICAL

Le ruban adhésif médical est idéal pour fixer les patchs et surélever les paupières tombantes.

MEDICAL ADHESIVE TAPE

Medical adhesive tape is ideal for keeping patches in place and taping up drooping eyelids.

137075 - 1,3 x 914 cm

TAPIS DE POSE

En silicone, le tapis de pose facilite la pose d'extensions de cils en maintenant les cils à la verticale, les rendant ainsi facilement saisissables.

APPLICATION MAT

This silicone application mat makes applying lash extensions more straightforward by keeping the lashes vertical, making them easier to pick up.

137060 - 14,5 x 9,5 cm



PIERRE DE JADE

La pierre de jade permet de conserver la qualité de la colle durant la pose d'extensions de cils.

JADE STONE

This jade stone is used to prevent the glue from drying out when applying eyelash extensions.

137090 - Ø 5 cm - Pierre naturelle / Natural stone





**PINCE EXTENSIONS DE CILS
EYELASH EXTENSION TWEEZERS**

137083 - prélever / Picking - 11 cm

137084 - prélever / Picking - 13 cm

137080 - isoler / Isolating - 13 cm

137081 - isoler / Isolating - 13 cm

137082 - isoler / Isolating - 13 cm

GOUPILLON JETABLE

Les goupillons jetables permettent de discipliner et démêler les cils.

DISPOSABLE GROOMING BRUSH

These disposable grooming brushes are for grooming and separating the eyelashes.

137091 - x 25



BAGUE JETABLE EXTENSIONS DE CILS

La bague jetable permet une pose d'extensions de cils rapide et donne de la souplesse dans les mouvements. Ce support empêche la colle de sécher pendant plusieurs heures. Son double réservoir offre la possibilité de disposer de 2 types de colle différents durant la séance d'application.

DISPOSABLE EYELASH EXTENSIONS RING

This disposable ring is the fast way to apply eyelash extensions, giving you freedom of movement. The ring stops the glue from drying for several hours. Two different types of glue can be used from the double-sided glue reservoir during application.

137066 - x 30



POIRE DE SÉCHAGE

La poire de séchage permet d'accélérer le séchage de la colle sans endommager la pose d'extensions de cils.

BLOWER BULB

Use this blower bulb to make the glue dry more quickly without damaging the newly applied lash extensions.

137070



MINI VENTILATEUR USB

Le mini ventilateur portable s'utilise à la suite d'une pose d'extensions de cils afin d'accélérer le séchage et ainsi la prise des cils synthétiques. Il apporte également plus de confort à la cliente en repoussant les vapeurs de colle pouvant représenter une gêne. Il possède une batterie longue durée qui se recharge sur port USB. Contient : 1 câble USB et 1 cordon de maintien.

USB MINI-FAN

This portable mini-fan is for use after applying eyelash extensions to speed up drying and therefore shorten the setting time of the glue used to apply synthetic lashes. It also improves client comfort by fanning away unpleasant glue vapours.

It has a long-life battery that can be recharged from any USB port.

Contents: 1 USB charging lead and 1 hanging cord.

137180 - 12 x 7 x 3 cm



LUNETTES LOUPES À ÉCLAIRAGE LED

Les lunettes permettent d'effectuer une prestation en toute précision.

Elles soulagent la vue et sont particulièrement appréciables lors d'une pose d'extensions de cils ou de Nail Art.

Éclairage LED x2 ajustable. 5 lentilles grossissantes interchangeables et ajustables : x1 / x1,5 / x2 / x2,5 / x3,5.

LED MAGNIFYING GLASSES

These glasses enable you to carry out high-precision work. They relieve eye strain and are particularly useful for eyelash extensions and nail art creations.

Adjustable LED light x 2. 5 interchangeable and adjustable magnifying lenses: x 1 / x 1.5 / x 2 / x 2.5 / x 3.5..

137092

DILUANT RETRAIT EXTENSIONS DE CILS

Le diluant de retrait permet de retirer délicatement les extensions sans abimer les cils naturels.

EYELASH EXTENSIONS REMOVER

This solvent gently removes extensions without damaging the natural eyelashes.

137051 - 15 ml - Texture gel / Gel texture



CRÈME RETRAIT EXTENSIONS DE CILS

La crème de retrait permet de retirer délicatement les extensions sans abimer les cils naturels.

EYELASH EXTENSIONS REMOVAL CREAM

This removal cream gently removes extensions without damaging the natural eyelashes.

137059 - 15 g - Texture crème / Cream texture



MICRO-BROSSE JETABLE

Les micro-brosses jetables sont idéales pour la dépose de cils. Elles permettent d'appliquer la crème (137059) ou le diluant de retrait (137051) ; mais également, d'ôter le surplus de colle lors de la pose d'extensions de cils, ou encore d'appliquer le primer (137061).

DISPOSABLE MICRO-BRUSH

These disposable micro-brushes are ideal for removing lashes. They are used to apply removal cream (137059) and extensions remover (137051), but can also be used to remove excess glue when applying lash extensions or for applying primer (137061).

137065 - x 100

NEW



KIT EXTENSIONS DE CILS

Le kit contient tous les produits et accessoires nécessaires au bon déroulement des poses d'extensions de cils.

LASH EXTENSIONS KIT

The kit contains all the products and accessories necessary.

137199 - Contient 1 pièce de chaque référence / Contains 1 piece of each reference: 137040, 137041, 137042, 137043, 137044, 137045, 137051, 137054, 137055, 137056, 137059, 137060, 137061, 137065, 137070, 137075, 137081, 137083, 137090, 137091, 137068.



TÊTE D'ENTRAÎNEMENT POUR EXTENSIONS DE CILS PRACTICE HEAD FOR EYELASH EXTENSIONS

137200

FAUX CILS D'ENTRAÎNEMENT PRACTICE FALSE EYELASHES

137201

| RÉHAUSSEMENT DE CILS / LASH LIFT

KIT RÉHAUSSEMENT DE CILS

Le kit comprend tout le nécessaire pour 10 poses de réhaussement de cils.

Kit de 10 poses contenant :

- 1 mode d'emploi, 1 colle transparente,
- 10 paires uni-doses de crèmes permanentes et fixatrices,
- 1 sérum à la kératine, 1 boîte de 10 bigoudis taille S x 2, taille M x 4 et taille L x 4,
- 10 micro-brosses, 15 mini-sticks, 1 tapis de pose.

LASH LIFT KIT

This kit contains everything you need for 10 lash lift applications.

Contents of 10-application kit :

- 1 instructions sheet, 1 clear glue, 10 pairs of single-dose perm and fixing creams,
- 1 keratin serum, 1 box of 10 curlers of different sizes : S x 2, M x 4, L x 4,
- 10 micro-brushes, 15 ministicks, 1 work mat.

138000



COLLE DE RÉHAUSSEMENT DE CILS

Pouvoir fixant et tenue idéale pour vous permettre de faire la pose dans les meilleures conditions. Facile à retirer à l'eau chaude et à l'aide d'une micro-brosse.

LASH LIFT GLUE

The extra-strength, perfect-hold glue makes application very straightforward. It's also easy to remove with hot water using a micro-brush.

138002 - 5 ml

MINI-STICKS

Le set de 15 mini-sticks est l'indispensable pour aider dans la pose de la colle de réhaussement de cils et dans le positionnement des patches en silicone, mais aussi démêler des cils. Les mini-sticks ont été spécialement conçus pour éviter tout risque d'oxydation des produits nécessaires au réhaussement.

MINI-STICKS

This set of 15 mini-sticks is an essential aid not only when applying lash lift glue and positioning silicone patches but also when separating lashes. These mini-sticks are especially designed to eliminate any risk of the lash lift products oxidizing.

138007 - x 15

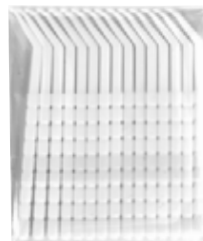

SÉRUM SOIN DES CILS KÉRATINE & COLLAGÈNE

Le sérum à la kératine et au collagène s'utilise en soin quotidien.

LASH-CARE SERUM WITH KERATIN & COLLAGEN

This serum containing keratin and collagen is for use as a daily eyelash treatment.

138003 - 5 ml

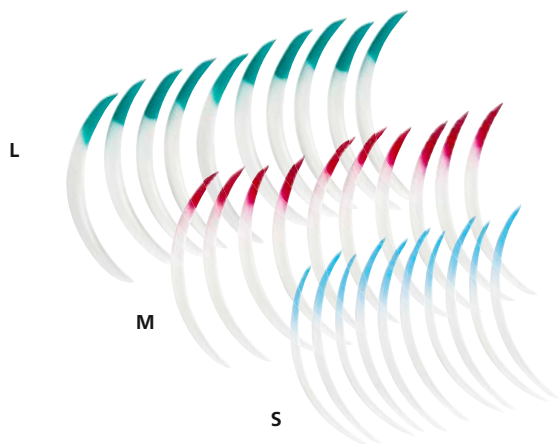

BOITE DE 10 PATCHS SILICONE

Les patchs en silicone sont conçus pour s'adapter aux longueurs des cils courts, moyens ou longs. Leur forme unique permet d'obtenir, selon le désir de chacun, une courbure intense ou plus naturelle, avec un seul et même patch en silicone. Ils sont nettoyables et réutilisables. Courbure naturelle (courbure J) souhaitée : mettre la partie colorée des bigoudis en direction de l'oreille gauche de la cliente. Courbure soutenue (courbure C) souhaitée : mettre la partie colorée des bigoudis en direction de l'oreille droite de la cliente.

BOX OF 10 CURLERS

These silicone patches are designed for short, medium-length and long lashes. Their unique shape enables you to produce a pronounced or a more natural-looking curl to suit using just one silicone patch. They are cleanable and re-usable. For a natural-looking curl (J curl): point the coloured part of the silicone patch towards the client's left ear. For a pronounced curl (C curl): point the coloured part of the silicone patch towards the client's right ear.

S- 138006 M- 138005 L- 138004

ASET 10 PAIRES UNI-DOSES DE CRÈMES PERMANENTES ET FIXATRICES

Les crèmes permanentes et fixatrices en sachets individuels uni-doses permettent d'utiliser la juste quantité de produit et de garantir une efficacité optimale ainsi qu'une hygiène parfaite.

SET OF 10 PAIRS OF SINGLE-DOSE PERM AND FIXING CREAMS

These perm and fixing creams come in individual single-dose sachets so that you use just the right amount, guaranteeing optimum results and faultless hygiene.

138001 - le set permet 10 poses / Enough for 10 applications.



| TEINTURE CILS & SOURCILS / LASH AND BROW TINT



138500
noir / black



138508
châtain clair /
light chestnut



138509
brun / brown



138510
bleu foncé / dark blue

KIT TEINTURE DE CILS ET SOURCILS

Teinture pour cils, sourcils et moustache, facile d'utilisation. Idéal pour intensifier le regard ou masquer l'arrivée des premiers poils blancs. Le kit contient : 1 flacon compte-gouttes d'oxydant 20 ml, 1 tube de coloration de 15 ml, 1 godet, 1 pinceau.

LASH AND BROW TINTING KIT

Easy-to-use tints for eyelashes, eyebrows and moustaches. The perfect way to create a more intense gaze or cover up those first grey hairs. Kit contents: One dropper bottle of oxidizer, 20 ml, One tube of colorant, 15 ml, One disposable plastic mixing cup, One lash and brow tinting brush.

TEINTURE CILS ET SOURCILS

Tube de crème colorante pour cils, sourcils et moustache, facile d'utilisation. Idéal pour intensifier le regard ou masquer l'arrivée des premiers poils blancs.

LASH AND BROW TINT

An easy-to-use colorant in a tube for eyelashes, eyebrows and moustaches. The perfect way to create a more intense gaze or cover up those first grey hairs.

15 ml - à utiliser avec l'oxydant 138505 / for use with oxidizer 138505



138501
black / noir



138502
châtain clair /
light chestnut



138503
brun / brown



138504
bleu foncé / dark blue



PINCEAU TEINTURE CILS ET SOURCILS

Parfait pour l'application de la teinture, ce pinceau dispose d'une tête étroite pour plus de précision et capture la juste dose de produit.

LASH AND BROW TINTING BRUSH

Perfect for applying tint, this brush has a narrow head for greater precision and holds just the right amount of product.

138506

GOSETS PLASTIQUES JETABLES

Set composé de 5 godets en plastique jetables idéal pour réaliser un mélange homogène de la teinture de cils avec l'oxydant. Jetables, ils assurent une hygiène parfaite.

PLASTIC DISPOSABLE MIXING CUPS

Set of 5 disposable plastic mixing cups. Perfect for creating an even mixture of lash tint and oxidizer. These cups are disposable, for faultless hygiene.

138507 - x 5



138511



138505

DÉTACHANT TEINTURE DE CILS

Le détachant est à utiliser immédiatement après la teinture. Il retire en douceur les tâches de teinture sur la peau ainsi que sur le matériel.

DYE REMOVER

This dye remover is for use immediately after tinting. It gently removes dye stains on skin and equipment.

138511 - 100 ml

OXYDANT

Oxydant pour teinture de cils. À mélanger avec les teintures Peggy Sage.

OXIDIZER

Oxidizer for lash tint. For mixing with Peggy Sage tints.

138505 - 20 ml



“ **WAXSHOP BY PEGGY SAGE : RETROUVEZ
NOTRE GAMME DE CIRE D'ÉPILATION
DE QUALITÉ PROFESSIONNELLE.** ”

Technique d'épilation répandue, Peggy Sage vous offre un large choix de cires à utiliser chaudes, tièdes ou froides. Les poils sont arrachés à la racine pour des résultats visibles jusqu'à trois semaines tout en respectant la peau de vos clients. Nous mettons notre savoir-faire au service de vos exigences grâce à une gamme complète avec des produits complémentaires et accessoires pour une prestation d'excellence.

“ **WAXSHOP BY PEGGY SAGE: A COMPLETE
RANGE OF PROFESSIONAL-QUALITY
DEPILATION WAXES.** ”

Waxing is a depilation technique now widely adopted. Peggy Sage offers an extensive selection of waxes for use hot, warm and cold. The hairs are removed at the root for visible results for up to three weeks while treating your clients' skin gently. We use our expertise to provide what you need in a complete range of complementary products and accessories, enabling you to provide a service of excellence.

CIRE CHAUDE / HOT WAX 256
CIRE TIÈDE / WARM WAX 258

CIRE FROIDE / COLD WAX 261
PRODUITS COMPLÉMENTAIRES
COMPLEMENTARY PRODUCTS 261

| CIRE CHAUDE / HOT WAX



601000
1 kg - rose

601001
1 kg - miel

601002
1 kg - vert

GALETS DE CIRE CHAUDE À ÉPILER SANS BANDE HOT DEPILATORY WAX TABLETS

601000 - rose - au dioxyde de titane - peaux déshydratées et sensibles
with titanium dioxide - dehydrated and sensitive skin

601001 - miel - tous types de peau / all skin types

601002 - vert - tous types de peau / all skin types

PERLES DE CIRE CHAUDE À ÉPILER SANS BANDE HOT DEPILATORY WAX PEARLS - STRIPLESS

601010 - rose - au dioxyde de titane - peaux déshydratées et sensibles
with titanium dioxide - dehydrated and sensitive skin

601011 - miel - tous types de peau / all skin types

601012 - vert - tous types de peau / all skin types



601010
1 kg - rose

601011
1 kg - miel

601012
1 kg - vert



601016
800 g - rose

601017
800 g - doré

601018
800 g - orange



PERLES DE CIRE CHAUDE À ÉPILER JETABLES, SANS BANDE TEXTURE EXCEPTIONNELLEMENT CRÉMEUSE ET ONCTUEUSE

Les perles de cire à épiler à base de résines et cire d'abeille s'utilisent chaudes à une température comprise entre 40° et 45°C. Cette cire s'applique sans bande, à l'aide d'une spatule.

HOT DEPILATORY WAX PEARLS - DISPOSABLE AND STRIPLESS - EXCEPTIONALLY SOFT AND CREAMY TEXTURE

These pearls of depilatory wax containing resins and bee's wax are for use hot at a temperature of between 40° and 45°C. This wax is stripless and is for spatula application.

601016 - rose - au dioxyde de titane - peaux déshydratées et sensibles
with titanium dioxide - dehydrated and sensitive skin

601017 - doré - tous types de peau / all skin types

601018 - orange - résine synthétique - peaux sensibles et réactives
synthetic resin - for sensitive and reactive skin

601019 - blanc - au dioxyde de titane - peaux sensibles et réactives
with titanium dioxide - for sensitive and reactive skin

601026 - monoi - tous types de peau / all skin types



601019
800 g - blanc

601026
800 g - monoi



**PERLES DE CIRE CHAUDE À ÉPILER JETABLES, SANS BANDE
TEXTURE SOUPLE, FACILITÉ D'APPLICATION
EN COUCHES FINES**

Les perles de cire à épiler à base de résines s'utilisent chaudes à une température comprise entre 40 et 45°C. Cette cire s'applique sans bande à l'aide d'une spatule.

**HOT DEPILATORY WAX PEARLS
DISPOSABLE AND STRIPLESS
SUPPLE TEXTURE, EASY TO APPLY THINLY**

These pearls of depilatory wax containing resins are for use hot at a temperature of between 40 and 45°C. This is a stripless wax for spatula application.

- 601014** - rose - au dioxyde de titane - peaux déshydratées et sensibles with titanium dioxide - dehydrated and sensitive skin
- 601015** - miel - tous types de peau / all skin types



601014
800 g - rose



601015
800 g - miel

**CIRE CHAUDE À ÉPILER LIPOSOLUBLE
JETABLE, SANS BANDE**

La cire à épiler liposoluble à base de résine s'utilise chaude à une température comprise entre 38° et 40°C. Elle s'applique sans bande, à l'aide d'une spatule.

**FAT-SOLUBLE HOT DEPILATORY WAX
DISPOSABLE AND STRIPLESS**

This fat-soluble depilatory wax containing resins is for use hot at a temperature of between 38° and 40°C. This wax is stripless and is for spatula application.

- 601020** - rose - au dioxyde de titane - peaux déshydratées et sensibles with titanium dioxide - dehydrated and sensitive skin
- 601021** - miel - tous types de peau / all skin types
- 601025** - monoï - tous types de peau / all skin types



601020
800 ml - rose



601021
800 ml - miel



601025
800 ml - monoï

CIRE CHAUDE À ÉPILER EXTRA-FLEX, JETABLE, SANS BANDE

La cire extra-flex doit son nom à sa formule concentrée en cire d'abeille, la rendant beaucoup plus malléable et élastique que les cires classiques. La cire à épiler Extra-flex liposoluble s'utilise chaude à une température comprise entre 38° et 40°C. Elle s'applique sans bande, à l'aide d'une spatule. Étendre la cire sur la surface à épiler. Ne pas laisser refroidir.

Tirer délicatement dans le sens inverse de la pousse du poil. Appliquer ensuite une huile ou un lait post-épilation afin d'éliminer les résidus de cire restants sur la peau.

EXTRA-FLEX HOT DEPILATORY WAX, DISPOSABLE, STRIPLESS

Extra-Flex wax is named after its formula containing bee's wax, which makes it much more malleable and elastic than conventional waxes. Extra-flex fat-soluble depilatory wax is for use hot at a temperature of between 38° and 40°C. This wax is stripless and is for spatula application. Spread the wax over the area to be depilated. Do not allow to cool. Pull it off gently in the opposite direction to the hair growth. Then apply a post-depilation oil or milk to remove the wax residue from the skin.

800 g - noire - tous types de peau / all skin types

601058

601024 - perles



601058
800 g - noire



601024
perles



POT DE CIRE À ÉPILER + SPATULE

Sans bande. Le pot de cire à épiler à base de résines et cire d'abeille se chauffe au micro-ondes.

Cette cire s'applique sans bande, à l'aide d'une spatule. Elle permet une épilation nette et durable pour 3 à 4 semaines.

POT OF HOT DEPILATORY WAX + SPATULA

Stripless. This pot of depilatory wax containing resins is for heating in a microwave oven. It is a stripless wax, formulated for spatula application. It results in clean, long-lasting depilation that will last for 3 to 4 weeks.

601091 - 300 g - tous types de peau / all skin types

| CIRE TIÈDE / WARM WAX

CARTOUCHE DE CIRE TIÈDE À ÉPILER LIPOSOLUBLE JETABLE, AVEC BANDE

Tête d'application roll-on large pour le corps.

CARTRIDGE OF FAT-SOLUBLE WARM DEPILATORY WAX

Wide roll-on body applicator.

601030 - rose - au dioxyde de titane - peaux déshydratées et sensibles with titanium dioxide - dehydrated and sensitive skin

601031 - miel - tous types de peau / all skin types

601032 - vert - tous types de peau / all skin types

601035 - nacré - peaux sensibles, poils courts et difficiles for sensitive skin and short problem hair

601036 - blanc - à l'oxyde de zinc - peaux réactives, sujettes aux imperfections, jeunes, premières épilations / with zinc oxide - reactive skin, skin with imperfections, young skin and first-time depilation

100 ml



601030
100 ml - rose



601031
100 ml - miel



601032
100 ml - vert



601035
100 ml - nacré



601036
100 ml - blanc



601040
100 ml - rose



601041
100 ml - miel

TÊTE D'APPLICATION ROLL-ON ÉTROITE POUR LE VISAGE CARTRIDGE OF FAT-SOLUBLE WARM DEPILATORY WAX

601040 - rose - au dioxyde de titane - peaux déshydratées et sensibles with titanium dioxide - dehydrated and sensitive skin

601041 - miel - tous types de peau / all skin types

100 ml

CIRE TIÈDE À ÉPILER LIPOSOLUBLE JETABLE, AVEC BANDE

La cire à épiler liposoluble à base de résines s'utilise tiède à une température comprise entre 37° et 39°C. Elle s'applique en fine couche à l'aide d'une spatule et se retire à l'aide de bandes.

FAT-SOLUBLE WARM DEPILATORY WAX

This fat-soluble depilatory wax containing resins is for use warm at a temperature of between 37° and 39°C. It is applied thinly with a spatula and is removed with strips.

601050 - 800 ml

rose - au dioxyde de titane - peaux déshydratées et sensibles
with titanium dioxide - dehydrated and sensitive skin

601051 - 800 ml

miel - tous types de peau / all skin types

601052 - 800 ml

vert - tous types de peau / all skin types

601055 - 800 ml

nacré - peaux sensibles, poils courts et difficiles
sensitive skin, short problem hair

601060 - 400 ml

601061 - 400 ml

601062 - 400 ml

601066 - 400 ml

blanc - à l'oxyde de zinc - peaux réactives, sujettes aux imperfections,
jeunes, premières épilations / with zinc oxide - reactive skin, skin with imperfections, young
skin and first-time depilation



601050
800 ml - rose



601051
800 ml - miel



601052
800 ml - vert



601055
800 ml - nacré



601060
400 ml - rose



601061
400 ml - miel



601062
400 ml - vert



601066
400 ml - blanc



601092



601093



601094

CIRE TIÈDE À ÉPILER AVEC BANDE CHAUFFAGE AU MICRO-ONDES & CHAUFFE-CIRE

La cire à épiler liposoluble à base de résines s'utilise tiède à une température comprise entre 37° et 39°C. Elle s'applique en fine couche à l'aide d'une spatule et se retire à l'aide de bandes. Étendre la cire sur la surface à épiler, plaquer une bande de tissu 10 à 20 secondes le temps que la cire adhère, puis tirer fermement d'un coup sec dans le sens inverse de la pousse du poil. Appliquer ensuite une huile ou un lait post-épilation afin d'éliminer les résidus de cire restants sur la peau.

FAT-SOLUBLE WARM DEPILATORY WAX, STRIP SYSTEM FOR MICROWAVE & WAX HEATER

This fat-soluble depilatory wax containing resins is for use warm at a temperature of between 37 and 39°C. It is applied thinly with a spatula and is removed with strips. Spread the wax over the area to be depilated and press on a fabric strip for 10 to 20 seconds until the wax adheres to it. Then pull firmly and sharply in the opposite direction to the hair growth. Afterwards, apply a post-depilation oil or milk to remove the wax residue from the skin.

601092 - miel - 700 ml - tous types de peau / all skin types

601093 - rose - 700 ml
peaux déshydratées et sensibles / dehydrated and sensitive skin

601094 - blanc - 700 ml
peaux réactives, sujettes aux imperfections, jeunes, premières épilations
reactive skin, skin with imperfections, young skin and first-time depilation



KIT 4 CARTOUCHES DE CIRE TIÈDE À ÉPILER

Contient :

- 4 x cartouches de cire tiède à épiler miel 100 ml
- 1 x bande non tissée pour cire à épiler x 250
- 1 x huile post-épilation à la camomille 150 ml
- 1 x chauffe-cartouche simple

4-CARTRIDGE OF WARM DEPILATORY WAX KIT

Contains :

- 4 x cartridge of warm depilatory wax miel 100 ml
- 1 x nonwoven strip for depilatory wax x 250
- 1 x post-depilation oil with camomile 150 ml
- 1 x single cartridge heater

601098

| CIRE FROIDE / COLD WAX

BANDES DE CIRE FROIDE À ÉPILER

Les bandes d'épilation sont pré-enduites de cire froide à base de résines.
Elles sont à usage unique et donc parfaitement hygiéniques.

COLD DEPILATORY WAX FACIAL STRIPS

These depilatory strips are pre-coated with cold wax containing resins.
They are single-use strips for perfect hygiene.

601070 - visage / face

10 x 2 bandes / strips 6 x 1,5 cm
+ 2 lingettes nettoyantes /
cleansing wipes

601071 - corps / body

10 x 2 bandes / strips 14 x 5,5 cm
+ 4 lingettes nettoyantes /
cleansing wipes



601070
visage
face



601071
corps
body

| PRODUITS COMPLÉMENTAIRES COMPLEMENTARY PRODUCTS



LINGETTES DÉSINFECTANTES

Les lingettes désinfectantes sont prêtes à l'emploi et à usage unique. Testées sous contrôle dermatologique, elles sont particulièrement efficaces avant et après l'épilation. Leur parfum rafraîchissant rend ainsi le soin plus agréable. Elles sont également efficaces sur le petit matériel médical et s'utilisent en toute circonstance pour se rafraîchir.

DISINFECTANT WIPES

These ready-to-use disinfecting wipes are for single use. Tested dermatologically, they are particularly effective before and after depilation. Their refreshing perfume makes the treatment a more pleasurable experience. They are also effective in sanitizing medical accessories and can be used at any time for freshening.

601110 - x 100

TALC PRÉ-ÉPILATION

Le talc pré-épilation élimine les traces de transpiration et favorise la prise du poil.
Il s'applique sur la zone à épiler avant d'étendre la cire afin d'éviter les rougeurs et petites inflammations.

PRE-EPILATION TALC

This pre-epilation talc removes all traces of perspiration and encourages adherence of the hairs. It is applied to the area to be depilated before coating it with wax, to prevent redness and minor inflammation.

601111 - 350 g





LOTION PRÉ-ÉPILATION

La lotion pré-épilation a une texture fluide et non collante. Elle adoucit la peau, élimine les traces de transpiration et favorise la prise du poil. Elle s'applique par modelage avant l'épilation qui devient facile, rapide et efficace.

PRE-DEPILATION LOTION

This pre-epilation lotion has a fluid, non-sticky texture. It softens the skin, removes all traces of perspiration and encourages adherence of the hairs. Apply with a sculpting action before depilation for easy, fast and effective hair removal.

601116 - 500 ml

EMULSION ANTI-REPOUSSE

Fluide et légère, cette emulsion est non collante et apporte confort et douceur à la peau. Composée de papaye et d'ananas, elle affaiblit la tige pileaire et ralentit l'évolution et la vigueur du système pileux. Elle s'applique quotidiennement et après chaque épilation.

HAIR GROWTH INHIBITOR

This light, fluid emulsion is non-sticky and leaves the skin feeling comfortable and soft. Containing papaya and pineapple extracts, it weakens the hair shaft, slowing growth and reducing the vigour of body hair. Apply daily and after each depilation.

601117 - 150 ml

601118 - 500 ml



601117
150 ml



601118
500 ml



601100
150 ml



601101
500 ml

HUILE POST-ÉPILATION

L'huile post-épilation parfumée à la camomille a une texture fluide et légère. Elle est non collante et apporte une agréable sensation de confort et de douceur. Elle s'applique immédiatement sur la zone épilée afin d'éliminer les résidus de cire restants sur la peau.

POST-DEPILATION OIL

This camomile-perfumed post-depilation oil has a light, fluid texture. It is non-sticky and leaves the skin feeling pleasantly comfortable and soft. Apply to the treated area immediately after depilation to remove wax residue from the skin.

601100 - 150 ml

601101 - 500 ml

LAIT POST-ÉPILATION

Le lait post-épilation à l'aloé vera a une texture fondante et non collante qui pénètre rapidement. Il laisse la peau souple et douce plus longtemps. Il s'applique immédiatement sur la zone épilée afin d'éliminer les résidus de cire restant sur la peau. L'application peut être répétée 3 à 4 fois dans les 24 heures qui suivent si la peau est très sensible.

POST-DEPILATION MILK

This post-depilation milk with aloe vera has a non-sticky melt-in texture that penetrates rapidly. It leaves the skin feeling supple and soft for longer. For application to the treated area immediately after depilation to remove wax residue from the skin. Application can be repeated 3 to 4 times within the next 24 hours if the skin is very sensitive.

601105 - 150 ml

601106 - 500 ml



601105
150 ml

601106
500 ml



601107
150 ml

601108
500 ml

HUILE DE MODELAGE & POST-ÉPILATION À L'HUILE D'ARGAN

L'huile de modelage et post-épilation riche en huile d'argan élimine les résidus de cire et nourrit intensément la peau. Elle apporte une agréable sensation de confort et de douceur. À appliquer immédiatement sur les zones épilées.

SCULPTING & POST-DEPILATION OIL WITH ARGAN OIL

This sculpting and post-depilation oil rich in argan oil removes wax residue and intensely nourishes the skin. It leaves the skin feeling pleasantly comfortable and soft. Apply to the depilated areas immediately after waxing.

601107 - 150 ml

601108 - 500 ml



601148
16 cm

SPATULE BOIS CORPS
WOODEN BODY SPATULA
601148 - 16 cm

601140 - 22 cm



601140
22 cm

SPATULE BOIS LÈVRES
WOODEN LIP SPATULA
601142 - 14,5 cm



SPATULE BOIS JAMBES
WOODEN LEG SPATULA
601143 - 24 cm

SPATULE MÉTALLIQUE JAMBES
METAL LEG SPATULA
601144 - 21 cm



601145
15 cm - x10



601146
15 cm - x200

SPATULES BOIS CORPS JETABLES
DISPOSABLE WOODEN BODY SPATULA

601145 - 15 cm - x10

601146 - 15 cm - x200



SPATULES BOIS VISAGE JETABLES
DISPOSABLE WOODEN FACIAL SPATULA
601147 - x50 - 11 cm



BANDES NON TISSÉES POUR CIRE À ÉPILER

Bandes non tissées pour retirer la cire tiède à épiler préalablement étalée sur la peau. Un mélange de fibres naturelles et synthétiques assure une qualité professionnelle et garantit une épilation efficace et en douceur.

NON WOVEN STRIPS VOOR EPILEERWAS

Non woven strips voor het verwijderen van eerder op de huid gesmeerde lauwarme epileerwas. Een mengsel van natuurlijke en synthetische vezels zorgt voor een professionele kwaliteit en garandeert een efficiënte en zachte ontharing.

601130 - 70x220mm - x50 **601131** - 70x220mm - x250



601130
x50

601131
x250



COLLERETTES ÉGOUTTE-CIRE WAX COLLAR

601121 - x50

POT VIDE

Le pot vide permet de faire fondre les perles ou les galets de cire chaude à épiler.

EMPTY POT

The empty pot is for melting depilatory wax pearls or tablets.

601160 - 800ml

601161 - 400ml



601160
800ml

601161
400ml



ANNEAU MÉTAL ÉGOUTTE-CIRE METAL WAX RING

601120

SOLVANT CIRE

Le solvant cire nettoie les résidus de cire sur tous les types de surfaces.

WAX SOLVENT FOR CLEANING TOOLS

This wax solvent cleans wax residue off all types of surfaces.

601150 - 1L





601200
400 ml

601201
800 ml

CHAUFFE-CIRE À ÉPILER

Les chauffe-cire à épiler 601200 (400 ml) et 601201 (800 ml) permettent de faire fondre la cire tiède à épiler liposoluble en pot et de la garder à bonne température durant toute l'épilation.

Vendu sans cire.

Garantie sur le matériel électrique : 2 ans.

DEPILATORY WAX HEATER

The depilatory wax heaters 601200 (400 ml) and 601201 (800 ml) are designed to melt fat-soluble warm depilatory wax in a pot and keep it at the correct temperature throughout the depilation treatment.

Wax not included.

Electrical equipment warranty: 2 years.

220-230 V 50/60 Hz - 100 W - 250 x 176 x 176 mm

601200 - 400 ml - 0,750 Kg

601201 - 800 ml - 0,800 Kg

COMBINÉ CHAUFFE-CARTOUCHE + CHAUFFE-CIRE

Un kit professionnel qui combine 2 chauffe-cartouche et 1 chauffe-cire pour pot de 400 ml/800 ml afin de faire chauffer les cires tièdes à épiler liposolubles simultanément ou séparément.

Les 2 interrupteurs permettent d'utiliser indépendamment les chauffe-cartouches et le chauffe-cire pour pot. Les différentes cires restent à bonne température durant toute l'épilation et peuvent être utilisées alternativement. L'épilation devient simple et efficace, quelles que soient les zones à épiler.

Vendu sans cire.

Garantie sur le matériel électrique : 2 ans.

COMBI-APPARAAT CASSETTEVERWARMERS + WASVERWARMER

A professional kit that combines 2 cartridge heaters and one 400ml-pot wax heater for heating fat-soluble warm depilatory waxes either simultaneously or separately.

The device has 2 power switches to enable the cartridge heaters and pot wax heater to be used independently. The different waxes are kept at the correct temperature throughout the depilation treatment and can be used alternately.

This makes depilation simple and effective, regardless of the areas being depilated.

Wax not included.

Electrical equipment warranty: 2 years

220-230 V 50 Hz - 150 W - 280 x 210 x 165 mm

601222 - 400 ml - 1,400 Kg

601223 - 800 ml - 1,430 Kg



601223
800 ml

601222
400 ml



**Chauffe
rapide
10-15 min.**

**Fast heating
10-15 min.**



601219

CHAUFFE-CARTOUCHE AVEC SOCLE

Vendu sans cartouche.

Garantie sur le matériel électrique : 2 ans.

CARTRIDGE HEATER WITH BASE

Cartridge not included.

Electrical equipment warranty: 2 years.

601219 - simple / mono - 220-230V 50Hz - 35W - 0,770 Kg - 220 x 100 x 170 mm
Il offre la possibilité de combiner jusqu'à 10 bases simultanément
afin d'obtenir un appareil multiple, uniquement sur la base simple.
Up to 10 bases can be combined at the same time to heat multiple waxes.

601216 - double / duo - 220-230 V 50Hz - 50W - 0,770 Kg - 205 x 190 x 150 mm



601216

601217 - triple / trio - 220-230 V 50Hz - 75W - 1,040 Kg - 290 x 205 x 170 mm



601217





**SAVOIR-FAIRE ET EXPERTISE À LA FRANÇAISE
SONT LES INGRÉDIENTS PRINCIPAUX
DE NOS PRODUITS DE SOIN.**



Peggy Sage vous propose des produits aux formules d'exception. Cette gamme complète de soins de qualité professionnelle répond de manière ciblée aux exigences de la peau de vos clients. Elle intègre une sélection rigoureuse d'actifs au service de l'efficacité, de la sécurité et de la sensorialité par des textures innovantes et fragrances délicates.



**FRENCH KNOW-HOW AND EXPERTISE ARE THE MAIN
INGREDIENTS OF OUR SKINCARE PRODUCTS.**



Peggy Sage has developed products with exceptional formulas. This complete range of professional-quality skincare products provides targeted solutions to your clients' skincare requirements. It incorporates carefully selected active ingredients designed to be effective, safe and appealing to the senses, with innovative textures and delicate fragrances.

SOIN DES MAINS / HAND CARE	270
SOIN DES PIEDS / FOOT CARE	280
SOIN DU VISAGE / FACE CARE	292

SOIN DU CORPS / BODY CARE	334
SOIN POUR HOMME MEN'S SKINCARE	362



SOIN / CARE

SOIN DES MAINS / HAND CARE

Embellir votre manucure avec un soin complet pour des mains resplendissantes.

Des soins de qualité pour des mains douces, lumineuses et délicatement parfumées.

Peggy Sage vous propose des produits efficaces et des protocoles complets : exfolier, modeler, hydrater et protéger.

Embellish your manicure with a full handcare treatment for stunning hands.

High-quality products for soft, bright and delicately perfumed hands. Peggy Sage offers a range of effective products and complete skincare procedures for exfoliating, sculpting, moisturizing and protecting.

| MANUCURIE TIÈDE / WARM MANICURE

La technique de la manucurie tiède Peggy Sage prodigue un véritable soin relaxant pour les mains et réparateur pour le contour de l'ongle comme pour la partie cornée.

The Peggy Sage warm manicure technique makes the hands feel wonderfully relaxed and repairs both the area around the nail and the horny part of the nail.

VITALCRÈME LOTION PRO-VITAMINÉE

Composée de vitamine E et provitamine B5, cette lotion est spécialement formulée pour redonner une nouvelle douceur et souplesse aux mains et aux ongles. Vitalcrème est un soin de manucurie tiède relaxant qui assure un résultat d'une douceur extrême. Grâce à son fort pouvoir émoullissant, il permet une manucurie efficace : au bout de 3 séances, l'état des ongles abîmés est nettement amélioré et les mains sont embellies.

VITALCRÈME LOTION WITH PROVITAMINS

This lotion containing vitamin E and provitamin B5 is specially formulated to give hands and nails a new softness and suppleness. Vitalcrème is a warm relaxing manicure lotion that produces extremely gentle results. It has excellent emollient properties that ensure an effective manicure: after three sessions the condition of damaged nails improves considerably and your hands will look more beautiful.

146057 - 100 ml

146058 - 500 ml

146059 - 1 l



11



KIT MANUCURIE TIÈDE

Contient 1 appareil, 2 coupelles, 1 lotion vitalcrème 100 ml, 1 mode d'emploi.
Garantie sur le matériel électrique : 2 ans.

WARM MANICURE KIT

Contains 1 heater, 2 cups, 1 vitalcrème lotion 100 ml, 1 instruction sheet.
Warranty on electrical equipment: 2 years.

146070 - 26 x 14 x 7,5 cm

LOT DE 20 COUPELLES OVALES PACK OF 20 OVAL CUPS

146072



x20

| SOIN PARAFFINE / PARAFFIN CARE



120024 - 2 x 500g



120124 - 2 x 500g

**LOT DE 2 PAINS DE PARAFFINE
PACK OF 2 PARAFFIN WAX BLOCKS**

120024 - 2x500g

120124 - 2x500g - au beurre de karité / karité butter

**PAIRE DE GANTS EN ÉPONGE POUR LES MAINS
PAIR OF TERRY TOWEL HAND GLOVES**
120029

**PAIRE DE GANTS EN ÉPONGE POUR LES PIEDS
PAIR OF TERRY TOWEL FOOT GLOVES**
120032

**LOT DE 100 SACHETS PLASTIQUES POUR LES MAINS
PACK OF 100 PLASTIC BAGS FOR HANDS**
120028 - x 100

**LOT DE 100 SACHETS PLASTIQUES POUR LES PIEDS
PACK OF 100 PLASTIC BAGS FOR FEET**
120033 - x 100

120029



120032



120028 - x 100



120033 - x 100



950ml



120ml

**PINCEAU PARAFFINE
PARAFFIN BRUSH**

141030 - 10,5 x 5 x 0,3 cm



141030

CLEANSE SPRAY HYGIÉNIQUE

Solution purifiante pour les mains, les ongles et le petit matériel.

CLEANSE HYGIENIC SPRAY

Purifying solution for hands, nails and small equipment.

146010 - 120ml

146011 - 950ml

KIT PARAFFINE

Contient 1 chauffe-paraffine, 8 pains de paraffine (8 x 500 g), 1 cleanse 146010, 1 masque onctueux 120780, 1 crème de soin 120760, 1 crème ultra hydratante 550320, 100 gants plastiques pour les mains, 100 gants plastique pour les pieds, 1 paire de gants éponge pour les mains, 1 paire de gants éponge pour les pieds, 1 pinceau paraffine.

Garantie sur le matériel électrique : 2 ans.

COMPLETE PARAFFIN WAX TREATMENT KIT

Contains 1 paraffin wax heater, 8 paraffin wax blocks (8 x 500 g), 1 cleanse 146010, 1 ultra nourishing cream mask 120780, 1 hand care cream 120760, 1 ultra-moisturizing cream 550320, 100 plastic hand gloves, 1 pair of terry towel hand gloves, 100 plastic foot gloves, 1 pair of terry towel foot gloves, 1 paraffin brush.

Garantie op elektrische apparatuur: 2 years.

120121



CHAUFFE-PARAFFINE / PARAFFINE WAX HEATER

Ergonomique et peu encombrant. Thermostat 2 positions - haute pour une fonte rapide de la paraffine et basse pour maintenir une température constante. Avec voyant lumineux et programmeur journalier. 220 V. Contenance max. 3,5 L. Garantie sur le matériel électrique : 2 ans.

Ergonomic and compact. 2-setting thermostat - high for quick paraffin wax melting and low for maintaining a constant temperature. With indicator light and daily timer. 220V. Max. capacity: 3,5 L. Warranty on electrical equipment: 2 years.

120031 - 30 x 25 x 15 cm

CRÈME DE SOIN MAINS ET ONGLES AU BEURRE DE KARITÉ

Enrichie en beurre de karité et en vitamines E et B5, cette crème légère aide à adoucir et protéger les mains.

CARE CREAM HANDS AND NAILS WITH SHEA BUTTER

Enriched with shea butter and vitamins E and B5, this light cream helps nourish, soften and protect your hands and fortify your nails.

120760 - 50 ml

MASQUE ONCTUEUX AU BEURRE DE KARITÉ ET HUILE DE BABASSU

La texture chantilly de ce masque fait fondre de plaisir. Beurre de karité et huile de babassu rendront vos mains infiniment douces, souples et confortables.

CREAM MASK WITH SHEA BUTTER AND BABASSU OIL

The whipped-cream texture of this mask will make you melt with pleasure! Containing shea butter which nourishes and regenerates, plus babassu oil which softens and repairs, it leaves your hands feeling delightfully soft, supple and comfortable.

120780 - 75 ml

CRÈME ULTRA HYDRATANTE AU BEURRE DE KARITÉ

Cette crème onctueuse hydrate intensément les pieds, même les plus secs, sans laisser de film gras. Sous l'action synergique du beurre de karité, de l'huile de germe de blé et d'un complexe naturel hautement hydratant, vos pieds sont souples et lisses. C'est le soin quotidien idéal pour avoir des pieds doux et hydratés tout au long de l'année.

ULTRA-MOISTURIZING CREAM WITH SHEA BUTTER

This rich, smooth cream hydrates even the driest feet intensely without leaving an oily film. The combined action of the shea butter, wheat germ oil and intensely moisturizing natural complex leaves your feet feeling soft and smooth. This is the perfect daily treatment for soft, moisturized feet throughout the year.

550320 - 100 ml



| SOIN DES MAINS / HAND CARE



75 ml



300 ml

MIEL DE GOMMAGE À LA PIERRE PONCE

Enrichi en huile de sésame et glycérine, ce gommage à la texture miel se transforme en huile puis en lait au contact de l'eau pour redonner souplesse à la peau. Les mains sont plus douces et visiblement plus belles.

HONEY SCRUB WITH PUMICE

Enriched with sesame oil and glycerin, this scrub with a honey-like texture turns into an oil and then a milk when mixed with water, restoring the skin's suppleness. It leaves your hands softer and visibly more beautiful.

120770 - 75 ml

120775 - 300 ml

120771

échantillon / sample

BAIN MANUCURE ÉMOLLIENT

Profitez pleinement des bienfaits de ces galets effervescents (vitamine B5 et acides aminés) qui promettent un véritable instant de détente, relaxation et bien-être.

EMOLLIENT MANICURE BATH

Soak up the benefits of these effervescent tablets (containing vitamin B5 and amino acids) that will help you relax and unwind, giving you a sense of well-being.

120750

x 10 galets effervescents
x 10 effervescent tablets

120755

x 50 galets effervescents
x 50 effervescent tablets



x 10

x 50



50 ml



270 ml

CRÈME DE SOIN MAINS ET ONGLES AU BEURRE DE KARITÉ

Enrichie en beurre de karité et en vitamines E et B5, cette crème légère aide à adoucir et protéger les mains.

CARE CREAM HANDS AND NAILS WITH SHEA BUTTER

Enriched with shea butter and vitamins E and B5, this light cream helps nourish, soften and protect your hands and fortify your nails.

120760 - 50 ml

120765 - 270 ml

120761

échantillon / monster



PRÉSENTOIR 10 MASQUES ONGLES ET CUTICULES X 24

Découvrez le masque spécial ongles et cuticules Peggy Sage, et son super cocktail d'actifs (beurre de karité, huile d'argan, huile de coco, vitamine E et kératine). Les masques ongles et cuticules Peggy Sage sont tactiles et vous permettent d'utiliser votre smart phone ou votre tablette pendant le soin. Idéal après une dépose de vernis semi-permanent.

NAIL AND CUTICLE MASK X 24

Check out the nail and cuticle mask from Peggy Sage, featuring an amazing cocktail of revitalizing active ingredients (shea butter, argan oil, coconut oil, vitamin E and keratin).

Peggy Sage nail and cuticle masks are tactile, so you can use your smartphone or tablet while they're doing their magic. Ideal after removing semi-permanent nail lacquer.

120980 - 10,5 x 9 x 23 cm



PRÉSENTOIR MASQUE HYDRATANT MAINS X 24

Retrouver des mains incroyablement douces et souples avec cette paire de gants imbibés d'un sérum à base de beurre de karité et huile d'argan. Le + : les bouts de gants se détachent pour réaliser une manucure parfaite pendant la pose du masque !

MOISTURIZING HAND MASK X 24

You can have incredibly soft, supple hands once again with these handcare gloves soaked with a serum containing shea butter and argan oil. Handy feature: the fingertips can be removed to enable you to enjoy the perfect manicure while the treatment is working!

120812 - 11 x 19 x 31 cm



75 ml



270 ml

MASQUE ONCTUEUX AU BEURRE DE KARITÉ ET HUILE DE BABASSU

La texture chantilly de ce masque fait fondre de plaisir. Beurre de karité et huile de babassu rendront vos mains infiniment douces, souples et confortables.

CREAM MASK WITH SHEA BUTTER AND BABASSU OIL

The whipped-cream texture of this mask will make you melt with pleasure! The shea butter and babassu oil it contains leave your hands feeling delightfully soft, supple and comfortable.

120780 - 75 ml

120785 - 270 ml

120781

échantillon / sample

CRÈME JEUNESSE ET CONFORT DES MAINS

Le soin indispensable pour préserver la jeunesse des mains sans dévoiler votre âge. Cette crème fondante enrichie en beurres de karité et cacao laisse les mains douces et souples.

HAND REJUVENATOR AND COMFORT CREAM

The essential treatment for keeping your hands young looking without revealing your age. This melt-in cream enriched with shea butter and cocoa butter leaves your hands feeling soft and supple.

120801 - échantillon / sample

120800 - 50 ml



50 ml



100 ml



CRÈME RÉPARATRICE POUR LES MAINS

Crème non grasse, idéale pour les mains abîmées et desséchées par le froid et les travaux quotidiens (lavages répétitifs, eau calcaire, matériaux corrosifs, ménage...).

REPAIR HAND CREAM

A non-oily cream ideal for hands damaged and dried out by the cold and daily life (repeated washing, hard water, corrosive products, household chores, etc.).

120790 - 100 ml

120791

échantillon / sample

GEL NETTOYANT MAINS
 Un gel moussant pour nettoyer les mains en douceur et les parfumer délicatement !
HAND CLEANSING GEL
 A foaming gel that cleanses your hands gently and perfumes them delicately!
 échantillon / sample 245 ml

Retrouvez la collection complète
« Évasion parfumée »
 de soin des mains et du corps
 page 351

See the full
“Évasion Parfumée” collection
 of hand care and bodycare products
 on page 351



121200
 agrumes / thé vert
 citrus / green tea
121201
 échantillon / sample



121205
 grenade - papaye
 pomegranate - papaya
121206
 échantillon / sample



121210
 mangue - passion
 mango - passion fruit
121211
 échantillon / sample



121215
 monoi - tiaré
 monoi - tiare
121216
 échantillon / sample



121220
 fleur de cerisier
 cherry blossom
121221
 échantillon / sample



121225
 noix de coco
 coconut
121226
 échantillon / sample



CAVIAR DE BAIN - fleur de cerisier

Idéales pour assouplir les mains et les cuticules, ces fines perles nacrées se métamorphosent au contact de l'eau en un bain lacté, délicieusement parfumé à la fleur de cerisier, pour un moment de relaxation intense.

BATH CAVIAR - Cherry blossom

The ideal way to soften your hands and cuticles, when added to water these delicate little pearls are transformed into a milky bath with a delightful cherry blossom fragrance that will treat you to a moment of intense relaxation.

440500 - 180g



600 ml



250 ml

GELÉE EXFOLIANTE - Fleur de cerisier et immortelle bleue

Composé d'extraits de fleur de cerisier, d'immortelle bleue et de poudre de noyaux d'abricots, la gelée exfoliante élimine les peaux mortes et assouplit la peau. Délicieusement parfumée, elle révèle des mains incroyablement douces et lumineuses.

EXFOLIATING JELLY - Cherry blossom and sea lavender

Containing cherry blossom and sea lavender extracts and powdered apricot stone, this exfoliating jelly removes dead skin and softens the skin. Delicately perfumed, it leaves your hands feeling incredibly soft and looking brighter.

440515 - 600 ml

440510 - 250 ml

440511

échantillon / sample

MASQUE MODELANT 2 EN 1
fleur de cerisier et immortelle bleue

Le masque modelant s'adapte à toutes les envies. Appliqué en masque, les mains sont intensément confortables. Utilisé en modelage, sa texture se transforme en huile et offre un moment de relaxation unique.

2-IN-1 SCULPTING MASK
Cherry blossom and sea lavender

This sculpting mask is perfect for every kind of use. Applied as a mask, it leaves your hands feeling exquisitely comfortable. Applied for sculpting, its texture transforms into an oil to treat you to a uniquely relaxing experience.

440521 échantillon / sample
440525 - 600 ml
440520 - 200 ml



600 ml



200 ml



100 ml

250 ml

BRUME SOYEUSE
fleur de cerisier et immortelle bleue

Des mains douces et confortables en un seul geste ! Cette brume à la texture fluide et légère adoucit et protège les mains sans laisser de film gras. Son parfum envoûtant ravive les sens et procure une douce sensation de plaisir. S'utilise à tout moment de la journée.

SILK MIST - Cherry blossom and sea lavender

Soft, comfortable hands in one go! With its light, fluid texture, this mist softens and protects your hands without leaving behind an oily film. Its bewitching fragrance revives the senses and induces a subtle feeling of pleasure. Can be used at any time of the day.

440530 - 100 ml
440535 - 250 ml

MAINS DE VELOURS
fleur de cerisier et immortelle bleue

Cette crème, enrichie de 20% de beurre de karité, procure des mains de velours. Les huiles de colza et de tournesol ainsi que les extraits de fleur de cerisier et d'immortelle bleue font un soin d'exception. Les mains sont douces et confortables sans aucun film gras.

VELVET HANDS - Cherry blossom and sea lavender

This creme, enriched with 20% shea butter, leaves your hands feeling velvety smooth. The rape seed and sunflower oils and cherry blossom and sea lavender extracts it contains make this creme oh-so good for your hands, leaving them soft and comfortable with no oily film on the skin.

440541 échantillon / sample
440545 - 200 ml
440540 - 50 ml



200 ml



50 ml



SOIN / CARE

SOIN DES PIEDS / FOOT CARE

Offrez aux pieds la magnificence et la souplesse qu'ils méritent grâce à nos soins ciblés.
Des pieds de rêve à la fois doux et confortables : cela devient possible grâce à notre gamme
aux actifs assouplissants, exfoliants et hydratants.

Give your feet the attractiveness and softness they deserve with our targeted footcare treatments.
Feet to die for that are both soft and comfortable: now you can thanks to our range containing softening,
exfoliating and moisturizing active ingredients.



x50

x10

BAIN DE PIEDS RELAX

Relaxe les pieds fatigués et gonflés, rafraîchit les pieds moites.

RELAXING FOOT BATH

Relaxes tired and swollen feet and refreshes perspiring feet.

550300 - 10 galets effervescents
10 tablets

550305
50 galets effervescents / 50 tablets

SEL DE GOMMAGE À L'HUILE D'AMANDE DOUCE

Pour une pédicure parfaite ! Ce sel de gommage aide à éliminer les peaux mortes et les rugosités grâce à sa formule enrichie en sels et en huile d'amande douce.

Il exfolie sans agresser pour laisser la peau douce.

SALT SCRUB WITH SWEET ALMOND OIL

For the perfect pedicure! With its formula enriched with salts and sweet almond oil, this salt scrub helps remove dead skin and rough areas. It exfoliates without damaging your skin, leaving it feeling delightfully soft.

550315 - 400 g

550310 - 100 ml



400 g



100 ml



100 ml

270 ml

CRÈME ULTRA HYDRATANTE AU BEURRE DE KARITÉ PIEDS SECS ET DÉSHYDRATÉS

Cette crème onctueuse hydrate intensément les pieds, même les plus secs, sans laisser de film gras. Sous l'action synergique du beurre de karité, de l'huile de germe de blé et d'un complexe naturel hautement hydratant, vos pieds sont souples et lisses. C'est le soin quotidien idéal pour avoir des pieds doux et hydratés tout au long de l'année.

ULTRA-MOISTURIZING CREAM WITH SHEA BUTTER FOR DRY AND DEHYDRATED FEET

This rich, smooth cream hydrates even the driest feet intensely without leaving an oily film. The combined action of the shea butter, wheat germ oil and intensely moisturizing natural complex leaves your feet feeling soft and smooth. This is the perfect daily treatment for soft, moisturized feet throughout the year.

550320 - 100 ml

550325 - 270 ml

550321
échantillon / sample



100 ml

CRÈME RÉPARATRICE ANTI-CALLOSITÉS

Le soin anti-callosités Peggy Sage soulage rapidement les pieds secs présentant des crevasses, talons fendillés et callosités.

CALLUS TREATMENT FOOT CREAM

Peggy Sage callus cream quickly soothes dry, chapped feet, cracked heels and calluses.

550330 - 100 ml

550331

échantillon / sample

BAUME RÉPARATEUR

Exceptionnellement riche en principes actifs à action adoucissante, le baume réparateur assure une multiprotection, améliore et restaure le confort des pieds les plus abîmés, fendillés ou douloureux.

REGENERATING BALM FOR FEET

Exceptionally rich in active ingredients with a softening action, this regenerating balm gives you multi-action protection, improving and restoring the comfort of even the most damaged, chapped and painful feet.

550341

échantillon / sample

550345 - 270 ml

550340 - 100 ml



270 ml



100 ml

**SPRAY RAFFRAICHISSANT
PIEDS ÉCHAUFFÉS ET GONFLÉS**

Le spray rafraîchissant assure fraîcheur et confort aux pieds échauffés et gonflés.

REFRESHING SPRAY FOR HOT, SWOLLEN FEET

This foot spray refreshes and soothes hot, swollen feet.

550350 - 100 ml



100 ml



100 ml



500 ml

GEL FRAÎCHEUR - JAMBES LÉGÈRES

Le gel jambes légères soulage rapidement les pieds échauffés et allège les jambes fatiguées en leur apportant une exceptionnelle impression de fraîcheur et un effet délassant immédiat.

COOL GEL FOR LIGHT LEGS

Light legs gel quickly relieves hot feet and revives tired legs, giving them an incredible sensation of freshness and inducing an immediate feeling of relaxation.

550360 - 100 ml

550363 - 500 ml

550361

échantillon / sample



MASQUE

Pieds

NOURRI
RAFRAICHI
BELLA

SANT

EXFOLIANT

MASQUE
Pieds

PRÉSENTOIR 12 MASQUES EXFOLIANTS PIEDS

Retrouver des pieds de bébé en une seule application. Enrichi en acides de fruits (citron, orange, kiwi...) ainsi qu'en extraits naturels de plantes (lavande, olive, thé vert, romarin, rose...), ce soin permet une exfoliation progressive pour retrouver des pieds doux et lisses. Les peaux mortes, callosités et rugosités seront naturellement éliminées entre 5 et 10 jours après le soin.

EXFOLIATING FOOT MASK X 12

For baby-soft skin after just one application. Enriched with fruit acids (lemon, orange, kiwi, etc.) and natural plant extracts (lavender, olive, green tea, rosemary, rose and more), these socks gradually exfoliate your feet, leaving them soft and smooth. Dead skin cells, calluses and rough areas are naturally removed between 5 and 10 days after treatment.

550372 - 10,5 x 14,3 x 20 cm



PRÉSENTOIR 24 MASQUE PIEDS NOURRISSANT

Nourrissant - rafraîchissant - délassant

Retrouver des pieds nourris, des talons adoucis ainsi qu'un effet rafraîchissant et décontractant immédiat avec cette paire de chaussettes imbibées d'un sérum enrichi en huile d'argan et beurre de karité ainsi qu'en extraits de lavande, camomille, menthe poivrée et eucalyptus.

DISPLAY OF 24 NOURISHING, REFRESHING AND RELAXING FOOT MASKS

Enjoy thoroughly nourished feet and soft heels plus an immediate refreshing and relaxed feeling with these treatment socks soaked with a serum enriched with argan oil, shea butter and extracts of lavender, camomile, peppermint and eucalyptus.

550374 - 17,3 x 11 x 17 cm



FOOT SPA



CRISTAUX EFFERVESCENTS AUX SELS D'EPSOM **agrumes**

Idéal pour relaxer, assouplir et parfumer, ce mélange de sels marins, cristaux pétillants et sels d'Epsom, allie les bienfaits de la mer pour un véritable moment de bien-être.

EFFERVESCENT CRYSTALS WITH EPSOM SALTS **citrus**

The perfect way to relax, soften and perfume your feet, this blend of marine salts, sparkling crystals and Epsom salts brings you all the benefits of the sea to induce a wonderful feeling of well-being.

440600 - 230g

GRANITÉ EXFOLIANT BIPHASÉ - agrumes-bambou

Délicieuses associations d'huiles de coco, d'abricot, d'amande ainsi que de sels marins et d'extraits de bambou, ce gommage biphasé élimine les peaux mortes. Délicatement parfumés, les pieds sont doux et souples.

TWO-PHASE GRANULAR EXFOLIATING FLUID - citrus-bamboo

Containing an indulgent blend of coconut, apricot and almond oil, plus marine salts and bamboo extracts, this two-phase scrub gently removes dead skin, leaving your feet delicately perfumed, soft and supple.

440615 - 550 g

440610 - 270 g



550 g



270 g



200 ml



600 ml

MASQUE MODELANT 2 EN 1 agrumes-bambou

Le masque modelant s'adapte à toutes les envies. Appliqué en masque, les mains sont intensément confortables.

Utilisé en modelage, sa texture se transforme en huile et offre un moment de relaxation unique.

2-IN-1 SCULPTING MASK citrus-bamboo

This sculpting mask is perfect for every kind of use. Applied as a mask, it leaves your feet feeling exquisitely comfortable. Applied for sculpting, its texture transforms into an oil to treat you to a uniquely relaxing experience.

440620 - 200 ml

440625 - 600 ml

440621

échantillon / sample

PIEDS DE SOIE agrumes-bambou

Cette crème, enrichie de 5% de beurre de karité, procure des pieds de soie. La glycérine végétale ainsi que l'extrait de bambou en font un soin d'exception. Sans aucun film gras, c'est le soin quotidien idéal pour avoir des pieds doux et confortables tout au long de l'année.

SILKY FEET citrus-bamboo

This cream, enriched with 5% shea butter, leaves your feet feeling silky smooth. The vegetable glycerin and bamboo extract it contains make this an exceptional foot cream. Because it leaves no greasy film, this is the perfect daily product for soft, comfortable feet all year long.

440631 - échantillon
monster

440630 - 100 ml



| ACCESSOIRES / ACCESSORIES



CAPSULES PROFESSIONNELLES POUR ORTEILS

Pour afficher des pieds de star : à coller à la base de l'ongle puis vernir selon votre humeur.

PROFESSIONAL TOENAIL TIPS

For the feet of a star: stick them to the base of the toenail and apply any nail lacquer you feel like.

142300 - x24: capsules assorties / assorted tips - 12 tailles / 12 sizes



LIME PÉDICURE 2 FACES CÉRAMIQUE ERGONOMIQUE

Sa surface céramique permet d'éliminer peaux mortes et callosités.

ERGONOMIC CERAMIC 2-WAY PEDICURE FILE

The ceramic surface can be used to remove dead skin and calluses.

300411

LIME PÉDICURE 2 FACES BOIS 2-WAY PEDICURE FILE WOOD

122065



LIME PÉDICURE 2 FACES 2-WAY PEDICURE FILE

122075 - GM / Large

LIME PÉDICURE PIERRE PONCE PUMICE STONE PEDICURE FILE

122076
jaune / yellow

122077
rose / pink

122078
bleu / blue

122079
vert / green



122076

122077

122078

122079

LIME PÉDICURE HYGIÈNE +

Elimine les callosités et peaux épaisses sous les pieds et aux talons pour retrouver des pieds doux et lisses. Ultra-hygiénique grâce à son compartiment récupérateur de peaux mortes amovible.

HYGIENE + PEDICURE FILE

Removes calluses and thick skin on the soles of the feet and heels, for soft, smooth feet once again. Ultra-hygienic thanks to its removable dead skin collector.

300412



RÂPE PÉDICURE INOXYDABLE + ÉMERIS JETABLES

La râpe inoxydable peut être désinfectée manuellement à froid ; les émeris adhésifs se changent après chaque utilisation. Ainsi tout risque de contamination par mycose est évité. Contient deux types d'émeris (fin et standard).

STAINLESS STEEL PEDICURE RASP + DISPOSABLE SANDING BANDS

This stainless steel rasp can be disinfected in a steriliser or manually in a cold bath; the disposable sanding bands are changed after every use, thereby avoiding any risk of mycosis contamination. Contains two types of sanding bands (fine and standard).

300401

300402 - 10 émeris adhésifs
10 adhesive sanding bands

PIERRE PONCE BLANC-BLEU MANUCURE ET PÉDICURE WHITE-BLUE PUMICE STONE MANICURE AND PEDICURE

123002



PIERRE PONCE VERTE MANUCURE ET PÉDICURE

Une forme ergonomique pour adoucir la peau des mains et traiter les callosités des pieds.

GREEN MANICURE / PEDICURE PUMICE STONE

Ergonomically shaped pumice stone for softening the skin on hands and treating foot calluses.

123003



155436
pearl

155437
diamond

SÉPARATEURS D'ORTEILS

En silicone, ces séparateurs d'orteils individuels vous offrent le choix de les utiliser en même temps, ou bien individuellement selon vos besoins. Confortables et pratiques, pour réaliser votre pose de vernis, gel ou résine sur vos ongles de pieds.

TOE SEPARATORS

These silicone individual toe separators can be used individually or all together as required. A comfortable and practical aid to the application of nail lacquer, gel or acrylic resin to your toenails.

PACK DE 10 PAIRES DE SÉPARATEURS D'ORTEILS

En mousse, astucieux et économique.

PACK OF 10 PAIRS OF TOE SEPARATORS

Made of foam, clever and economical.

155433



155432

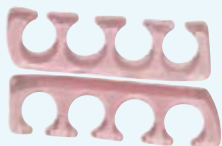

155434

PAIRE DE SÉPARATEURS D'ORTEILS EN SILICONE

Inspirés de la podologie pour un confort optimal lors de vos poses de vernis, résine ou gel sur les ongles des pieds.

PAIR OF SILICONE TOE SEPARATORS

Inspired by podiatry for optimum comfort when applying nail lacquer, acrylic resin or gel to the toenails.

155432 - vert / green

155434 - rose / pink

1 PAIRE DE SÉPARATEURS D'ORTEILS TULIPE ROSE

1 PAIR OF TOE SEPARATORS PINK TULIP

155431

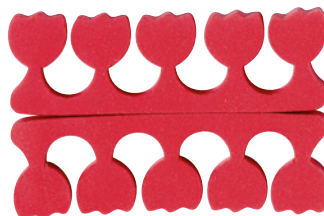

1 PAIRE DE SÉPARATEURS D'ORTEILS

1 PAIR OF TOE SEPARATORS

155430

COUPE-CORS

Acier inoxydable.

CORN CUTTER

Stainless steel.

300021 - boîte de 10 lames / box of 10 blades

300020



300020



300021 - x10



PINCE PÉDICURE POUR ONGLES INCARNÉS

PEDICURE NIPPER FOR INGROWN NAILS

300060 - 11,5 cm, becs pointus, ressort tournant, pour couper les esquilles d'ongles.

Acier inoxydable

Pointed jaws, double spring, for cutting off small shards of nail. Stainless steel.

PINCE À ONGLES "SÉCATEUR"

NAIL NIPPER "SECATEURS"

300003 - 14 cm, becs concaves, fermail automatique, pour ongles durs. Acier inoxydable

Concave jaws, self opening, for hard nails. Stainless steel.



PINCE À ONGLES PÉDICURE

PEDICURE NAIL NIPPER

300000 - 14 cm, becs concaves, fermail automatique. Acier inoxydable.

Concave jaws, self opening clasp. Stainless steel.

HYDROMASSEUR FOOT SPA

Détente et relaxation pour vos pieds.

Ergonomique et design, l'hydromasseur complète votre prestation de soin de beauté des pieds. Il permet de régler la température et l'oxygénation par les bulles pour un plus grand confort de votre clientèle.

Livré avec un second jeu interchangeable de masseurs de la voûte plantaire ainsi qu'un trio boule de massage / pierre ponce / brosse interchangeable à fixer sur le centre de l'appareil.

Garantie sur le matériel électrique : 2 ans.

FOOT SPA HYDROMASSAGER

Soothes and relaxes your feet. This smart, ergonomically designed hydromassager completes your foot beauty treatment offering. The temperature and bubbleoxygenation settings can be adjusted for maximum client comfort.

Supplied with a second interchangeable set of massage jets for the arch of the foot and an interchangeable triple massage ball / pumice stone / brush fitting for the centre of the hydromassager.

Warranty on electrical equipment: 2 years.

500001 - 230 V 50 Hz - 40 x 22 x 45 cm - 3,9 kg





SOIN / CARE

SOIN DU VISAGE / FACE CARE

Des soins sur-mesure pour toutes les peaux, même les plus exigeantes !

Le meilleur du savoir-faire français est réuni dans cette gamme de soins.

La performance et le confort ont été associés pour révéler l'éclat de votre visage.

Treatments tailored to every skin type, even the most demanding ones!

This range of treatments incorporates the very best of French expertise, combining performance and comfort to bring out your face's true radiance.

| DÉMAQUILLER CLEANSING

LOTION DOUCE DÉMAQUILLANTE YEUX

Enrichie en eau de bleuet, elle possède des propriétés apaisantes et assure un démaquillage parfait des cils et des paupières.

SOFT MAKE-UP REMOVER LOTION FOR EYES

Enriched with cornflower water, this lotion has soothing properties and ensures faultless cleansing of your eyelashes and eyelids.

134051 échantillon / sample

134060 - 1L

134050 - 125 ml



1L



125 ml



125 ml

1L

DÉMAQUILLANT BIPHASE YEUX

Une formule biphasée, composée d'extrait d'eau de bleuet, qui élimine tous les maquillages, même waterproof, sans effet gras.

TWO-PHASE EYE CLEANSER

A two-phase formula containing cornflower water extract that removes all make-up, even waterproof, with no oily effect.

400020 - 120 ml

400021 - 1L

HUILE DÉMAQUILLANTE DOUCEUR

Douce et délicieusement fondante, cette huile élimine les traces de maquillage les plus tenaces.

GENTLE CLEANSING OIL

This gentle oil with a delightful melt-in texture removes even the stubbornest traces of make-up.

400023 - échantillon / sample

400022 - 200 ml



200 ml



LINGETTES DÉMAQUILLANTES

Ces lingettes démaquillantes permettent de démaquiller le visage et les yeux d'un seul geste.

MAKE-UP REMOVER TOWELS

Ideal to use when travelling, they contain a hypoallergenic solution formulated under pharmaceutical control. They remove eye and skin make-up in a single move without irritation.

400025 - x25



LAIT DÉMAQUILLANT VITAMINÉ

Élimine toutes les impuretés et laisse la peau nette et lumineuse.

CLEANSING MILK WITH VITAMINS

Removes all impurities and leaves the skin clean and bright.

400000 - 200 ml

400001 - échantillon / sample

400005 - 990 ml

400006 - 5L

200 ml

990 ml

5L

LAIT DÉMAQUILLANT MOUSSANT

La mousse délicate et fraîche de ce soin nettoie les peaux mixtes ou normales à tendance grasse.

FOAMING CLEANSING MILK

This product's delicate, cool foam cleanses combination skin and oily-prone normal skin.

400011 - échantillon / sample

400015 - 1L

400010 - 200 ml



1L

200 ml



198 ml

1L

EAU MICELLAIRE

Cette eau micellaire à la fleur d'oranger nettoie, démaquille et rafraîchit en un seul geste. Elle laisse la peau propre, douce et confortable.

MICELLAR WATER

Micellar water with orange blossom cleanses, removes make-up and refreshes in one go. It leaves your skin feeling clean, soft and comfortable.

400130 - 198 ml

400135 - 1L

400131
échantillon / sample

EAU DÉMAQUILLANTE

Ultra-douce, cette eau démaquille efficacement votre visage. Enrichie aux extraits d'iris, elle laisse votre peau parfaitement nettoyée et tonifiée.

CLEANSING WATER

This ultra-gentle cleansing water removes make-up from your face very effectively. Enriched with iris extracts, it leaves your skin perfectly cleansed and toned.

400018 - échantillon / sample 400017 - 1 L 400016 - 200 ml



200ml

1L



5L

LOTION TONIFIANTE AUX EXTRAITS DE PLANTES

Elle renforce l'action soin du démaquillant vitaminé en éliminant les dernières traces de maquillage. Elle procure douceur et souplesse.

TONIFYING LOTION WITH PLANT EXTRACTS

Boosts the skin-care action of the cleanser with vitamins by removing the last traces of make-up, leaving your skin soft and supple.

400030 - 200 ml 400031 - échantillon / sample

400035 - 1L

400036 - 5L

LOTION TONIQUE ÉQUILIBRANTE

Formulée à base d'extrait de bardane, la lotion tonique est particulièrement recommandée pour équilibrer les peaux jeunes et à tendance grasse.

BALANCING TONIC LOTION

Formulated with burdock extract, this toner is particularly recommended for balancing young and oily-prone skin.

400041 - échantillon / sample 400045 - 1 L 400040 - 200 ml



1L

200ml



ROSÉE SUPER HYDRATANTE

Une lotion qui apporte une sensation immédiate de fraîcheur et rend à la peau souplesse et tonicité. Elle hydrate l'épiderme et vivifie le teint. Compatible avec les feuilles de collagène.

SUPER MOISTURIZING DEW

This alcohol-free lotion provides immediate freshness and restores skin flexibility and tonicity. It nourishes your epidermis and vitalizes your complexion. Compatible with collagen sheets.

400050 - 200 ml

400055 - 1 L

400051 échantillon / sample

| NETTOYER - EXFOLIER / CLEANSING - EXFOLIATING

CRÈME NETTOYANTE CONFORT

Pour les adeptes du nettoyage à l'eau. Formulé à base de beurre de karité, beurre de cacao, huile de lin et lait de coton la crème nettoyante confort élimine rapidement maquillage et impuretés.

GENTLE CLEANSING CREAM

For those who prefer to cleanse with water, this gentle cleansing cream quickly removes make-up and impurities to leave your skin clean and clear. Enriched with shea butter, cocoa butter, linseed oil and cotton milk, your skin will be perfectly nourished and soothed.

400057 - échantillon /sample

400056 - 150 ml



MOUSSE NETTOYANTE MICRO-EXFOLIANTE

Découvrez le secret de cette mousse qui, en plus de nettoyer votre peau, améliore la qualité de votre grain de peau. Sous l'action conjuguée d'un complexe naturel qui exfolie l'épiderme en douceur, d'extraits naturels et de vitamines aux vertus hydratantes, régénérantes et adoucissantes ; la peau est nettoyée, la peau agressée quotidiennement est apaisée. Jour après jour, le grain de peau s'affine pour un teint plus clair, plus lumineux.

MICRO-EXFOLIATING CLEANSING MOUSSE

Discover the secret of this mousse which not only cleanses your skin but also refines your skin grain. Through the combined action of a natural complex that gently exfoliates the epidermis and natural extracts and vitamins with moisturizing, regenerating and softening properties, this mousse cleanses and soothes skin which is exposed to harsh conditions every day. Day after day it refines the skin grain, creating a clearer and brighter complexion.

400028 - 150 ml





GEL DOUX NETTOYANT

Formulé à partir de bases lavantes douces et d'extraits de plantes, ce gel nettoie la peau tout en douceur.

GENTLE CLEANSING GEL

Formulated with gentle cleansing bases and plant extracts, this gel cleanses the skin very gently.

401330 - 200 ml

401331 - échantillon / sample

GEL EXFOLIANT VISAGE

Les particules exfoliantes du gel gomment en douceur l'épiderme et ses imperfections. Votre teint devient clair et lumineux.

EXFOLIATING FACE GEL

The gel's exfoliating particles gently scrub your skin, removing imperfections to leave your complexion looking clear and radiant.

Texture gel transparent - gommage mécanique à grains transparente geltextuur - mechanische peeling met korrels

400060 - 50 ml

400065 - 250 ml

400061 - échantillon / sample

400165 - 1L



50 ml

250 ml

1L

CRÈME GOMMANTE RÉVÉLATEUR D'ÉCLAT

Spécialement développée pour gommer les peaux mortes qui asphyxient la peau, cette crème révèle l'éclat de votre visage, tout en douceur. Utilisée régulièrement, la peau est plus lumineuse, le teint plus uniforme.

RADIANCE REVEALING CREAM SCRUB

Specially developed to exfoliate dead skin cells that suffocate the skin, this cream gently brings out your face's full radiance. It contains extract of pomegranate which closes your pores and regenerates your skin, giving it a smoother appearance.

texture crème blanc nacré - gommage mécanique à peluches
white cream texture - Manual exfoliating peel

400163 - 1L

400063 - 250 ml

400062 - 50 ml



NEW

NEW



GOMMAGE CHIMIQUE

Ce gel irisé à la texture fondante et au parfum fruité révèle l'éclat de la peau. Ce gommage élimine efficacement les peaux mortes et les impuretés. Celle-ci est nette, unifiée et le teint parfaitement lumineux.

CHEMICAL EXFOLIATION

This shimmering gel with a melt-in texture and fruity fragrance brings out the skin's radiance. This scrub effectively removes dead skin and impurities, leaving the skin clean and even with a wonderfully bright complexion.

Texture gel irisé / iriserende gelttextuur

401463 - 50 ml

401465 - 250 ml

401466 - 1L



GOMMAGE GOLD

Délicieusement parfumé, ce gommage au sucre roux exfolie délicatement la peau. Il combine les huiles de jojoba et de pépins de raisin naturellement hydratantes à un extrait de caviar, très riche en vitamines A, D, B, oligo-éléments et acides aminés essentiels. Le teint est lumineux et durablement éclatant.

GOLDEN ANTI-AGEING SCRUB

This delightfully perfumed brown sugar scrub gently exfoliates the skin. It contains naturally moisturizing jojoba and grape pip oils combined with a caviar extract very rich in vitamins A, D and B, oligo-elements and essential amino acids. It brightens your complexion, giving it a long-lasting radiance.

401450 - 250 ml - texture crème or - gommage mécanique à grains gold cream texture - Manual exfoliating peel

GOMMAGE ÉCLAT DU TEINT

Douce et onctueuse, cette crème de gommage élimine les impuretés. L'éclat du teint est réveillé en douceur, la peau douce et nette.

RADIANT COMPLEXION SCRUB

This soft and creamy scrub removes impurities. It gently revives the complexion's radiance, leaving the skin soft and clean.

401445 - 250 ml - texture crème blanc nacré - gommage mécanique à grains fins pearly white cream texture - manual fine-grain scrub



PRÉSENTOIR 24 MASQUES TISSU MOUSSANTS AU CHARBON

Ce masque tissu moussant composé de charbon actif, d'acides de fruits et d'extraits d'origine végétale nettoie et élimine les peaux mortes.

La peau est nette et éclatante.

DISPLAY OF 24 FOAMING CHARCOAL FABRIC MASKS

This foaming fabric mask containing active charcoal, fruit acids and plant extracts cleanses and removes dead skin, leaving your skin clean and radiant.

470211 - x 1

470210 - 9,3 x 17 x 11,3 cm



470211



470221

PRÉSENTOIR 24 X 3 PATCHS NEZ

Les patchs purifiants pour le nez éliminent efficacement les points noirs et désincrustent les pores. Pratiques et rapides, la peau est nette et matifiée.

DISPLAY OF 24 X 3 NOSE PATCH

A purifying nose patch is an effective way of removing blackheads and cleansing pores deep down. Practical and fast, it leaves your skin clean and mattified.

470220 - 7 x 17 x 11,3 cm

470221 - x 1

| MASQUES CRÈME / CREAM MASKS



MASQUE HYDRATANT RELAXANT

Un soin hydratant et relaxant qui agit en 10 minutes comme un coup d'éclat pour procurer au visage douceur et confort.

MOISTURIZING RELAXING MASK

The moisturizing and relaxing skin care provides softness and comfort to your skin in 10 min.

Texture gel transparente rosée / pink-tinted clear gel texture

401200 - 50 ml

401201 - échantillon / sample

401250 - 250 ml

401251 - 1 L

MASQUE HYDRATANT CONTOUR DES YEUX

Enrichi en actifs hydratants, lissants, raffermissants et tonifiants, ce masque deviendra très vite indispensable à votre secret de beauté. Hydraté, votre regard retrouve tout son éclat et sa fraîcheur.

EYE CONTOUR MOISTURIZING MASK

Enriched with moisturizing, smoothing, firming and toning active ingredients, this mask will quickly become an essential part of your secret beauty routine. Moisturized, your gaze will regain its full radiance and freshness.

401261 - échantillon / sample

401260 - 30 ml



MASQUE HYDRATATION INTENSE

Un véritable bain d'hydratation pour un délicieux moment de relaxation. Désaltérée, la peau retrouve confort, souplesse et éclat.

INTENSE HYDRATION MASK

A total moisturizing bath for a delicious moment of relaxation. The skin receives all the moisture it needs, becoming comfortable, supple and radiant once again.

401435 - 250 ml - texture crème bleue / blue cream texture





NEW

MASQUE PURIFIANT À L'ARGILE VERTE

Avec ce soin, le grain de la peau s'affine et le teint s'éclaircit. Ce masque purifie la peau, la nettoie en profondeur et absorbe l'excès de sébum. Elle reste douce, assainie, et les pores dilatés se resserrent.

PURIFYING MASK WITH GREEN CLAY

With this skin care, the epidermis is refined and the complexion is cleared up. This mask purifies your skin, cleansing it deep down and absorbing excess sebum. It leaves your skin soft and clean and closes open pores.

Texture crème verte / green cream texture

401100 - 50 ml

401101 - échantillon / sample

401150 - 250 ml

401151 - 1 L

MASQUE RÉGULATEUR AU CAMPBRE

Le masque au camphre est idéal pour les peaux mixtes à grasses de par les vertus du camphre, de l'extrait d'iris et de la vitamine A. La mise en beauté est immédiate, la peau plus belle.

REGULATING MASK WITH CAMPHOR

This camphor mask is ideal for combination and oily skin because of the properties of the camphor, iris extract and vitamin A it contains. The beautifying effect is immediate, leaving your skin looking more stunning.

401405 - 250 ml - texture crème blanche / white cream texture



MASQUE APAISANT À L'AZULÈNE

Concentré en azulène et bisabolol, ce masque crème a été spécialement formulé pour répondre aux besoins des peaux les plus sensibles. Ces actifs rigoureusement sélectionnés pour leurs propriétés adoucissantes et apaisantes permettent de soulager les irritations et de diminuer les rougeurs.

SOOTHING MASK WITH AZULENE

A concentrated source of azulene and bisabolol, this cream mask has been specially formulated to meet the needs of even the most sensitive skin. Its active ingredients have been carefully selected for their softening and soothing properties, relieving irritation and reducing redness.

401415 - 250 ml - texture crème bleue / blue cream texture

MASQUE RÉPARATEUR HAUTE NUTRITION

Gorgé d'actifs nourrissants (beurre de karité, beurre de cacao, huile de noisette) et hydratants (Lipidure®), ce masque rend la peau plus souple, plus confortable et sans tiraillement. Nourrie, protégée votre peau retrouve toute sa douceur et votre teint est rayonnant !

HIGH-NUTRITION REGENERATING MASK

Packed with nourishing (shea butter, cocoa butter and hazelnut oil), hydrating (Lipidure), this mask makes your skin smoother, suppler and more comfortable without causing tightness. Nourished and protected, your skin regains all its softness and your complexion looks radiant!

texture crème / Cream texture

400871 - échantillon / sample

400870 - 50 ml

400875 - 250ml

400876 - 1L



MASQUE PEEL-OFF ÉCLAT

Ce masque pelliculable élimine toutes les impuretés et les peaux mortes grâce au pouvoir exfoliant de l'extrait de papaye.

PEEL-OFF RADIANCE MASK

This peel-off mask removes all impurities and dead skin thanks to the exfoliating properties of the papaya extract it contains.

Texture gel transparente rose orangée / orangey pink-tinted clear gel texture

401460 - 50 ml

MASQUES TISSU / TISSUE MASKS

Ces masques tissu épousent parfaitement les contours du visage

These tissue masks fits the contours of the face perfectly



470211

PRÉSENTOIR 24 MASQUES TISSU MOUSSANTS AU CHARBON

Un visage détoxifié : ce masque tissu moussant enrichi en charbon actif, acides de fruits et extraits d'origine végétale nettoie, élimine les peaux mortes et aide à réguler l'excès de sébum. La peau est lisse, nette et éclatante.

DISPLAY OF 24 FOAMING CHARCOAL FABRIC MASKS

The ultimate facial detox. This foaming fabric mask enriched with active charcoal, fruit acids and plant extracts cleanses, removes dead skin and helps regulate excess sebum, leaving your skin smooth, clean and radiant.

470210 - 9,3 x 17 x 11,3 cm

470211 - x 1

MASQUE ULTRA HYDRATANT - DÉFATIGANT

Ce masque fibre épouse parfaitement les contours du visage. Idéal pour réveiller votre peau et l'hydrater en profondeur.

ULTRA-MOISTURIZING MASK - REVIVING

This fibre mask covers the contours of the face perfectly. It holds a very high concentration of active ingredients and optimizes their diffusion through the epidermis.

401278 - 23 ml



MASQUE PURIFIANT - ANTI-IMPERFECTIONS

Ce masque fibre épouse parfaitement les contours du visage. Ses actifs purifient et absorbent l'excès de sébum pour une peau nette, mate et un teint clarifié.

ANTI-BLEMISH PURIFYING MASK

Its active ingredients purify and absorb excess sebum, leaving the skin clean and matte with a clearer complexion.

401271 - 23 ml

MASQUE HYDRATANT - APAISANT

Les peaux déshydratées et fatiguées profitent d'un véritable bain d'hydratation qui apporte douceur et confort.

MOISTURIZING AND SOOTHING MASK

It holds a very high concentration of active ingredients and optimizes their diffusion through the epidermis.

401270 - 23 ml



MASQUE NOURRISSANT - RÉPARATEUR

Enrichi en miel et beurre de karité, il nourrit et répare la peau pour une sensation de confort durable.

NOURISHING MASK - REPAIRING

Enriched with honey and shea butter, it nourishes and repairs the skin for a lasting feeling of comfort.

401279 - 23 ml



MASQUE ILLUMINEUR - ÉCLAT

Grâce aux pouvoirs conjugués de ses actifs illuminateurs, votre peau retrouve son éclat.

ILLUMINATING MASK - RADIANCE-REVEALING

Through the combined effect of its illuminating active ingredients it restores your skin's radiance.

401277 - 23 ml

MASQUE LISSANT - ANTI-ÂGE

La puissance de ses actifs anti-rides, lissant et repulpant, rend la peau lumineuse, visiblement plus jeune et éclatante de beauté.

SMOOTHING ANTI-AGEING MASK

Its powerful wrinkle-reducing, smoothing and re-plumping active ingredients leave the skin bright, visibly younger-looking and radiant with beauty.

401272 - 23 ml



MASQUES TECHNIQUES / POUDRES À MÉLANGER

TECHNICAL MASKS / MIXING POWDERS



MASQUE ALGINATE CONTOUR DES YEUX

Ce peel off contour des yeux est composé d'une poudre de riz et de collagène marin qui, associés à l'alginate, crée un film qui renforce les fonctions protectrices de la peau.

SMOOTHING ANTI-AGEING MASK

This peel-off eye contour mask contains rice powder and marine collagen which, combined with alginate, create a film that reinforces the skin's protective functions.

440090 - 6 x 30 g

MASQUE ALGINATE PROVENÇAL VISAGE ET CORPS

Ce masque puise au cœur de la Provence (romarin, lavande, olive...) de multiples bienfaits qui laissent la peau douce, souple et lumineuse.

PROVENÇAL ALGINATE MASK FOR FACE AND BODY

This mask derives many benefits from produce from rural Provence such as rosemary, lavender and olives, which leave your skin soft, supple and bright.

Texture coagulable / coagulable texture.

440081 - 6 x 30 g

440082 - 5 Kg



MASQUE PEEL OFF VITAMINÉ

Retrouvez une peau lumineuse avec ce masque vitaminé. Composé d'acérola connu pour sa richesse en vitamine C ainsi que de papaine, ce masque pelliculable réveille intensément l'éclat de votre peau.

PEEL-OFF VITAMIN MASK

Restore your skin's brightness with this vitamin mask. Containing *Malpighia glabra*, known to be rich in vitamin C, along with papain, this peel-off mask gives your skin's radiance an intense boost.

440070 - 6 x 30 g - texture coagulable / coagulable texture



MASQUE GOLD

MASQUE GOLD

Enrichi en perles de culture qui éclairent la peau, ce précieux soin de couleur or révèle la beauté et l'éclat du teint.

GOLDEN MASK

Enriched with cultivated pearls that lighten the skin, this precious golden-coloured treatment brings out the beauty and radiance of your complexion.

440050 - 6 x 30 g - texture coagulable / coagulable texture





MASQUE ÉCLAT À LA POUDRE DE RIZ

Retrouvez une peau lumineuse et fraîche avec ce masque cocooning à la poudre de riz.

RADIANCE MASK WITH RICE POWDER

Have bright, fresh skin once again with this pampering rice powder mask.

440060 - 6x25 g - texture crèmeuse / cream texture



250 g

NEW



5 Kg

MASQUE THERMIQUE

Produit à partir de gypse naturel, le masque thermique possède deux actions simultanées. Une action chauffante qui favorise la pénétration des actifs et une action de sudation provoquée par l'effet occlusif qui permet d'éliminer les impuretés.

THERMAL MASK FACE AND BODY

Made with natural gypsum, this thermal mask has two simultaneous actions: a warming action that encourages penetration of the active ingredients and a perspiration-inducing action caused by its occlusive effect which eliminates impurities.

Texture plâtre / plaster texture

440040 - 6x250 g

440042 - 5 Kg

| MASQUES COLLAGÈNE / COLLAGEN MASKS

FEUILLES DE COLLAGÈNE

Idéal pour les peaux déshydratées et sèches, ces feuilles constituées de fibres de collagène natif permettent une hydratation intense. La peau réhydratée retrouve élasticité et éclat. Les traits sont regonflés.

COLLAGEN SHEETS

Ideal for dehydrated and dry skin, these sheets containing native collagen fibres provide intense hydration. Your skin is rehydrated, regaining elasticity and radiance, and your features are replenished.

400125 - 6x5g - 21x29,7 cm

400124 - 5g

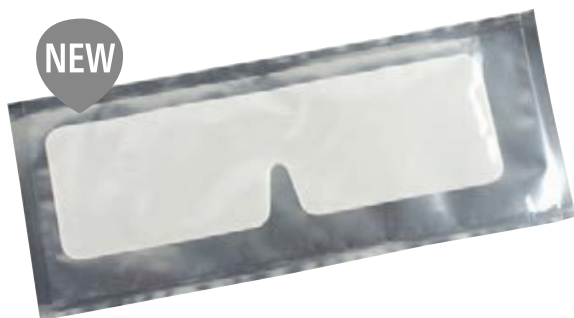

LUNETTES DE COLLAGÈNE

Ces lunettes constituées de fibres de collagène natif permettent une hydratation intense. La peau réhydratée retrouve élasticité et éclat.

COLLAGEN GLASSES

These glasses made entirely of native collagen fibres moisturize the skin intensely, restoring its elasticity and radiance.

400126 - x1

400127 - x25

| SÉRUMS & AMPOULES / SERUMS & AMPOULES

SÉRUM HYDRATATION INTENSE

Retrouver une peau souple, rebondie et idéalement hydratée avec le sérum hydratation intense. Sa texture fondante enrichie en acide hyaluronique est associée à un actif ultra hydratant issu d'une plante australe pour apporter à la peau une hydratation intense. La peau retrouve confort et éclat, et peut faire face aux agressions quotidiennes.

INTENSE HYDRATION SERUM

Enjoy soft, plumped and perfectly hydrated skin with this intense hydration serum.

Its melt-in texture enriched with hyaluronic acid is combined with an ultra-hydrating active ingredient obtained from a southern plant that hydrates your skin intensely and leaves it soothed, radiant and able to cope with the harsh conditions of everyday life.

400802 - échantillon / sample

400801 - 30 ml



100ml

30ml

SÉRUM PURIFIANT ANTI IMPERFECTIONS

Retrouvez une peau parfaite avec ce sérum anti-imperfections. Cette formule d'exception resserre les pores, affine le grain de peau, et réveille le teint. Infiniment plus lisse, votre peau est plus douce, plus lumineuse.

BLEMISH-REDUCING PURIFYING SERUM

Restore your skin to perfection with this blemish-reducing serum. This exceptional formula closes your pores, refines your skin grain and revives your complexion. Infinitely smoother, your skin will be softer and more luminous.

401350 - 30 ml

401353 - 100 ml

401351 - échantillon / sample

SÉRUM APAISANT

Soin spécial peaux agressées, il est la solution idéale pour les peaux sensibles et réactives. Concentré en oméga 6 céramide (obtenu à partir d'une huile végétale de carthame) ainsi qu'en extraits de mauve et de réglisse, ce sérum apaise rapidement l'épiderme, le protège et diminue la réactivité de la peau. Parfaitement apaisée, la peau devient souple, douce et confortable.

SOOTHING SERUM

A serum developed especially for damaged skin, this is the perfect solution for sensitive and reactive skin. Containing a concentration of omega 6 ceramide (obtained from safflower oil) and mallow and liquorice extracts, this serum quickly soothes and protects your skin, reducing its reactivity. Wonderfully soothed, your skin becomes supple, soft and comfortable.

400361 - échantillon / sample

400363 - 100 ml

400360 - 30 ml



30ml

100ml



SÉRUM HAUTE NUTRITION

Soin d'exception pour répondre aux besoins des peaux les plus sèches, ce sérum soulage les sensations d'irritations, répare et nourrit la peau. Jour après jour, l'épiderme est protégé, les sensations de tiraillements et d'inconfort disparaissent et la peau retrouve douceur et souplesse.

HIGH-NUTRITION SERUM

This amazing serum meets the needs of even the driest skin, relieving feelings of irritation and repairing and nourishing your skin. Day after day it protects the epidermis. Any feelings of tightness and discomfort disappear, leaving your skin soft and supple.

400850 - 30 ml

400851 - échantillon / sample

ÉCLAT BEAUTÉ MINUTE

Idéal pour retrouver un visage rayonnant avant une soirée ou pour surmonter les matins difficiles. Ce sérum peut s'utiliser comme base de maquillage. La performance éclat-minute s'explique par la présence d'actifs phyto-tenseurs naturels.

INSTANT BEAUTY RADIANCE

Ideal for restoring the face's radiance before a night out or for getting over a difficult morning. This serum can be used as a pre-make-up cream. The instant radiance performance is produced by active ingredients that have a natural phyto-tensor effect.

Texture sérum transparente rosée - pink-tinted clear serum texture

400701 - échantillon / sample

400700 - 30 ml





SÉRUM JEUNESSE À LA GELÉE ROYALE

Véritable concentré d'actifs, ce sérum vient booster l'action de la crème de jour et de nuit. Au cœur de la formule, un concentré de gelée royale qui, très riche en éléments nutritifs, atténue les signes du vieillissement, et permet ainsi à la peau de conserver souplesse et tonicité. Associé à des agents anti-rides hautement hydratants et à des extraits de grenade et d'acérola reconnus pour détoxifier, restructurer la peau, le sérum jeunesse lisse la peau, repulpe et raffermi l'épiderme pour révéler une nouvelle jeunesse.

YOUTH SERUM WITH ROYAL JELLY

This serum containing a concentration of active ingredients boosts the action of day cream and night cream. Its formula contains a concentration of royal jelly, very rich in nutrients, which fades signs of ageing and enables the skin to remain supple and toned. Combined with intensely hydrating anti-wrinkle agents and extracts of pomegranate and acerola, which are known to detoxify and restructure the skin, this youth serum smooths the skin and plumps up and firms the epidermis to reveal a new youthfulness.

Texture crème blanche / white cream texture

400561 - sample

400563 - 100 ml

400560 - 30 ml



30 ml

100 ml



20 ml

NEW



1 ml

SÉRUM AQUEUX IONISABLE

Ce sérum aqueux procure un effet bonne mine grâce à l'association de l'eau d'hamamélis, du FucoCERT®, des extraits de bardane et de sureau.

IONISABLE AQUEOUS SERUM

This aqueous serum contains a blend of witch hazel, FucoCERT® and burdock and elderberry extracts which creates a healthy glow effect.

401155 - 20 ml

401156 - 10 ampoules x 1 ml



20 ml

NEW



1 ml

SÉRUM HUILEUX

Enrichi en vitamines, antioxydants et acides gras essentiels, ce sérum huileux adoucit et assouplit la peau en lui apportant les éléments essentiels à sa protection. Type de peau : sèches et/ou mures.

OILY SERUM

Enriched with vitamins, antioxidants and essential fatty acids, this oily serum softens the skin and increases suppleness by providing your skin with essential protective elements. Skin type: dry and/or mature.

400855 - 20 ml

400856 - 10 ampoules x 1 ml

SÉRUM ÉCLAT

Redonner un véritable coup d'éclat à votre peau avec ce sérum concentré en agents d'origine marine et végétale et enrichi en vitamine B.

RADIANT FACE SERUM

Have bright, fresh skin once again with this pampering rice powder mask.

Texture aqueuse transparente / clear aqueous texture

400752 - 10 x 1 ml

400751 - 20 ml

400750 - 3 x 1 ml



NEW

NEW

COFFRET DE 3 AMPOULES HUILEUSES À L'AZULÈNE

Assouplit et calme les irritations. Les propriétés adoucissantes et anti-inflammatoires de l'azulène sont idéales pour les peaux sèches et sensibles.

BOXED SET OF 3 OIL AMPOULES WITH AZULENE

Softens and soothes irritations. The softening and anti-inflammatory properties of azulene are ideal for dry and sensitive skin.

401540 - 3 x 3 ml - texture huileuse bleue / blue oily texture



3 x 3 ml

3 AMPOULES PRÉCIEUSES AU CAVIAR

Soin précieux au caviar, à l'ADN marin et à l'acide hyaluronique. Ce sérum adoucit, lisse et désaltère la peau en procurant à l'épiderme tous les éléments nutritifs nécessaires à la préservation de sa beauté et de sa jeunesse.

3 PRECIOUS CAVIAR AMPOULES

A precious treatment containing caviar, marine DNA and hyaluronic acid. This serum softens and hydrates the skin by providing the epidermis with all the elements it needs to preserve its beauty.

401542 - 3 x 2 ml - texture aqueuse transparente / transparent aqueous texture



CURE INTENSE 10 JOURS À LA GELÉE ROYALE

Véritable élixir de jeunesse, la gelée royale permet de prolonger la douceur et la jeunesse de la peau. Concentrée en éléments essentiels revitalisants : vitamines, oligo-éléments, minéraux, acides gras essentiels, elle est associée à des agents hydratants et restructurants pour une peau éclatante de vitalité.

10-DAY INTENSE ROYAL JELLY TREATMENT REGIME

Royal jelly works like a 'youth elixir', keeping your skin softer and more youthful-looking for longer. It contains a concentrated blend of revitalizing essential elements: vitamins, oligo-elements, minerals and essential fatty acids, combined with moisturizing and restructuring agents that leave your skin radiant with vitality.

400580 - 10 x 1 ml

AMPOULES ASSORTIES

Sérum huileux x 2

Aqueux x 2

Eclat visage x 2

COMBISET AMPULLEN

Olieachtig serum x 2

Waterachtig serum x 2

Stralende glans serum voor het gezicht x 2

400755 - 6 x 1 ml



ROLL-ON ANTI-IMPERFECTIONS

Le roll-on anti-imperfections s'utilise à tout moment de la journée pour réduire les imperfections localisées. Huiles essentielles 100% pures et naturelles.

ANTI-BLEMISH ROLL-ON

You can use this anti-blemish roll-on to reduce small blemishes at any time of the day. Contains 100% pure and natural essential oils.

401360 - 4 ml

| SOIN CONTOUR DES YEUX / EYE CONTOUR CARE



GEL CONTOUR DES YEUX

Ce gel apaisant apporte au contour de l'œil un degré d'hydratation élevé sans laisser de film gras. Il décongestionne les paupières et estompe les cernes. Contient des actifs hydratants et apaisants associés aux eaux distillées d'hamamélis et de bleuet.

EYE CONTOUR GEL

This soothing gel intensely hydrates the area around the eyes without leaving an oily film. Decongests the eyelids and fades dark circles. Contains hydrating and soothing active ingredients combined with distilled hazel and cornflower water.

Texture gel transparente bleue / blue clear gel texture

400090 - 15 ml

400091 - échantillon / sample

CRÈME CONTOUR DES YEUX ANTI-ÂGE À L'EXTRAIT DE THÉ VERT

Formulée spécialement pour prévenir et atténuer les rides et ridules de la partie ultrasensible du tour de l'œil. Réhydratée et nourrie, la peau retrouve un aspect lisse et souple.

EYE CONTOUR CREAM ANTI-AGEING WITH GREEN TEA EXTRACT

Specially formulated to prevent and reduce wrinkles and fine lines in the highly sensitive area surrounding the eye. Moisturized and nourished, the skin regains a smooth, supple appearance.

Texture crème blanche / white cream texture

400101 - échantillon / sample

400100 - 15 ml



ROLL-ON ÉCLAT REGARD

Le regard est reposé grâce à un cocktail d'actifs végétaux sélectionnés pour leur action adoucissante.

ROLL-ON RADIANT GAZE

Your gaze will have a rested look thanks to this cocktail of plant active ingredients selected for their softening action.

400770 - 10 ml



| CRÈMES DE SOIN / CARE CREAMS



50 ml



250 ml

CRÈME HYDRATATION INTENSE

La crème hydratation intense associe un agent hydratant puissant, l'Aquaxyl, à des céramides végétales, des filtres solaires, de la vitamine A et un complexe nutritif d'huiles végétales, pour hydrater et protéger la peau. Parfaitement hydratée, votre peau retrouve confort et souplesse.

INTENSE HYDRATION CREAM

This intense hydration cream combines a powerful hydrating agent, Aquaxyl, with plant ceramides, sunscreens, vitamin A and a nutritive complex of vegetable oils that hydrate and protect your skin. It leaves your skin perfectly hydrated and comfortable and supple once again.

400400 - 50 ml

400405 - 250 ml

400401

échantillon / sample

CRÈME FLUIDE NON GRASSE

Cette crème légère hydrate la peau sans laisser de film gras, diminue la taille des pores et la brillance et la protège des agressions extérieures grâce à l'association d'un extrait végétal purifiant, de céramides végétales, de vitamine.

FLUID OIL-FREE CREAM

For matified, hydrated skin: this light cream hydrates the skin without leaving behind an oily film, reduces pore size and shine and protects your skin from harsh conditions thanks to its combination of a purifying plant extract, plant ceramides, vitamin E and sunscreens.

400201

échantillon / sample

400205 - 250 ml

400200 - 50 ml



250 ml



50 ml





50 ml



200 ml

CRÈME ACTIVE

La crème active apaise et protège les peaux les plus délicates et fragiles grâce à un complexe apaisant (tétrapeptide pur). Adoucissante et hydratante, elle apporte à la peau confort et éclat, la protège des facteurs climatiques et du vieillissement cutané (filtres UVA/UVB, vitamine E) et réduit ainsi les phénomènes d'hypersensibilité et de tiraillement.

ACTIVE CREAM

This active cream soothes and protects even the most delicate and fragile skin thanks to its soothing complex containing pure tetrapeptide. Softening and hydrating, it makes your skin feel comfortable and radiant and protects it from the elements and ageing (UVA and UVB filters and vitamin E), thereby reducing the phenomena of hypersensitivity and tightness.

Texture crème blanche / white cream texture

400300 - 50 ml

400350 - 200 ml

400301

échantillon / sample

CRÈME APAISANTE ANTI-ROUGEURS

Ce soin visage quotidien est recommandé pour estomper les rougeurs et diminuer l'apparence des petits vaisseaux sanguins. Il renferme un complexe apaisant, qui associé à du thé blanc et des extraits de calendula et de coquelicot permet de calmer les irritations, retrouver un teint uniforme ainsi qu'une peau confortable et apaisée.

REDNESS-REDUCING SOOTHING CREAM

This daily facial cream is recommended for fading redness and reducing the appearance of tiny blood vessels. It contains a soothing complex (horse chestnut, licorice, etc.) which, combined with white tea and calendula and poppy extracts, calms irritations and restores an even complexion, leaving your skin feeling comfortable and soothed. Its soothing green texture, invisible on the skin, helps to reduce redness and even the complexion.

400371 - échantillon / sample

400370 - 50 ml



50 ml



250 ml

CRÈME HAUTE NUTRITION

Cette crème offre la richesse des beurres et des huiles naturelles (karité, Inca Inchi, macadamia) et la douceur des extraits de baobab. Confortable et riche, elle protège, nourrit, et répare les épidermes fragilisés.

HIGH-NUTRITION CREAM

This cream combines rich butters and natural oils (shea, Inca Inchi and macadamia) with gentle baobab extracts. This comfortable, rich cream protects, nourishes and repairs damaged skin.

400860 - 50 ml

400865 - 250 ml

400861

échantillon / sample

CRÈME ÉCLAT DU TEINT

Conçu pour réveiller l'éclat du teint, ce soin affine le grain de peau. Plus lumineuse, plus uniforme et idéalement hydratée, la peau retrouve tout son éclat.

RADIANT COMPLEXION CREAM

Formulated to revive the complexion's radiance, this cream stimulates new skin cell growth, refining the skin texture and correcting visible signs of ageing by acting on marks and blemishes. Smoother, brighter, more even and perfectly hydrated, your skin will regain its youthful radiance thanks to the exceptional properties of Kombuchka and palmitoyl glycine.

400711 - échantillon / sample

400710 - 50 ml



50 ml



200 ml

CRÈME ANTI-ÂGE À LA GELÉE ROYALE

Grâce à l'action combinée de la gelée royale, reconnue pour ses éléments exceptionnellement nutritifs, de la vitamine A et d'un complexe d'huiles naturelles végétales riches en vitamines E et F, la crème anti-âge Peggy Sage agit comme un véritable ralentisseur d'âge. La peau est raffermie et les traits sont lissés.

ANTI-AGEING CREAM WITH ROYAL JELLY

Thanks to the combined action of royal jelly, recognised for its exceptionally nutritive constituents, vitamin A and a complex of natural vegetable oils rich in vitamins E and F, Peggy Sage anti-ageing cream appears to slow the ageing process. It firms the skin and smooths out lines.

Texture crème / cream texture

400500 - 50 ml

400550 - 200 ml

400501 - échantillon / sample

CRÈME RÉGÉNÉRANTE NUIT À LA GELÉE ROYALE

Gelée royale, acide hyaluronique, actifs régénérants, huile de pépin d'argousier et extrait d'huileux de fleur de frangipanier se conjuguent pour une peau plus souple, plus fraîche, plus jeune. La peau est fraîche et défroissée. Les rides se combent, la peau est raffermie et repulpée.

REGENERATING NIGHT CREAM WITH ROYAL JELLY

Restore the smooth, radiant appearance of youth from the moment you wake. Royal jelly, hyaluronic acid, regenerating active ingredients, sea buckthorn seed oil and oily extract of frangipani flower combine to make your skin suppler, fresher and younger-looking. Night after night, it fades signs of tiredness. Your skin will be fresh and smoothed. Wrinkles will fade and your skin will be firmer and plumped up.

Texture crème blanche / white cream texture

400571 - échantillon / sample

400570 - 50 ml



| SOIN DES LÈVRES / LIPS CARE



NEW



NEW



Retrouvez la collection complète
« Évasion parfumée »
 de soin des mains et du corps
 page 351

See the full
“Évasion Parfumée” collection
 of hand care and bodycare products
 on page 351

BAUME LÈVRES

À emporter partout avec soi pour des lèvres durablement protégées et délicieusement parfumées.

LIP BALMS

With this go-anywhere lip balm, you can have lastingly protected and deliciously perfumed lips.

5,5 ml

115030 - agrumes - thé vert
 citrus - green tea

115031 - grenade - papaye
 pomegranate - papaya

115032 - mangue - passion
 mango - passion fruit

115034 - monoi - tiaré
 monoi - tiareblomma

115040 - fleur de cerisier
 cherry blossom

115041 - noix de coco
 coconut

PRÉSENTOIR 36 BAUMES LÈVRES

Contient 6 pièces de chaque baume 5,5 ml.

DISPLAY OF 36 LIP BALMS

Contains 6 of each fragranced lip balm, 5.5 ml.

115042 - ø 23 x 13 cm



**BAUME RÉPARATEUR LÈVRES
FINI GLOSSY AU BEURRE DE KARITÉ**

Retrouver le sourire avec ce baume enrichi en vitamine E, beurre de karité, huiles de macadamia, ricin et germe de blé. Sa texture, délicieusement fondante, ne colle pas et laisse un fini glossy divinement naturel.

REGENERATING LIP BALM - GLOSSY FINISH

This lip balm soothes, repairs and protects dry and damaged lips. Its texture is not sticky and leaves a divinely natural-looking glossy finish on your lips.

115020 - 15 ml



BAUME LÈVRES

Garder le sourire avec ce baume qui protège durablement les lèvres gercées et abîmées.

LIP BALM

Keep on smiling with this lip balm which gives you long-lasting protection for chapped and damaged lips.

110004 - 4g

DETOX

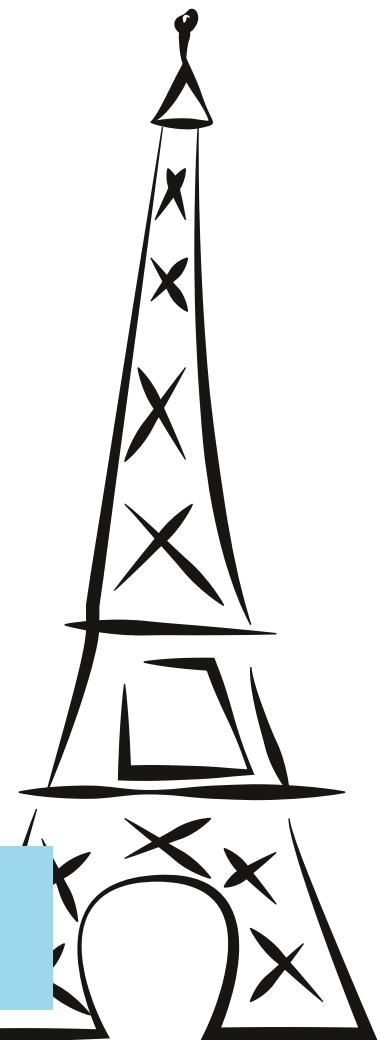

50 ml

MASQUE EXFOLIANT AU CHARBON

Ce masque noir au charbon de bambou libère votre peau de toutes les impuretés présentes à sa surface. Sa texture huileuse se transforme délicatement en lait au contact de l'eau. Votre peau est propre et nette.

CHARCOAL EXFOLIATING MASK

This black mask containing bamboo charcoal rids your skin of all the impurities on the surface. Its oily texture gently turns into a milk on contact with water, leaving your skin wonderfully cleansed.

470130 - 50 ml

470132 - échantillon / sample

HUILE DÉMAQUILLANTE ÉCLAT AU CHARBON

Cette huile démaquillante élimine délicatement les impuretés et traces de maquillage même tenaces. Composée de charbon de bambou, sa texture huileuse se transforme délicatement en lait au contact de l'eau. La peau est propre pour un teint frais et éclatant.

RADIANT FACE CLEANSING OIL WITH CHARCOAL

This cleansing oil gently removes impurities and even stubborn traces of make-up. Containing bamboo charcoal, its oily texture gently turns into a milk on contact with water, leaving your skin clean for a fresh, radiant complexion.

470102 - échantillon / sample

470100 - 200 ml



200 ml

SÉRUM BOOSTER D'ÉCLAT

Offrez une cure détox à votre peau ! Composé d'un actif provenant de cellules souches végétales, le sérum booster d'éclat agit comme un bouclier protecteur pour une peau plus nette et plus belle !

RADIANT FACE BOOSTER SERUM

Pamper your skin with a detox treatment! Containing an active ingredient obtained from plant stem cells, this radiance booster serum acts like a protective shield, for clearer, more beautiful skin!

470112 - échantillon / sample

470110 - 30 ml



30 ml



50 ml

SOIN PROTECTEUR HYDRATANT SPF20

Protéger votre peau au quotidien avec ce soin qui agit comme un bouclier contre les rayons du soleil. Vous êtes protégés pour affronter la journée et son lot de stress quotidien.

MOISTURIZING PROTECTOR SPF20

Protect your skin every day with this product which acts like a shield against the sun's rays. It keeps your skin safe, enabling you to cope with the stresses and strains of daily life.

470120 - 50 ml

470122 - échantillon / sample

PRÉSENTOIR 24 MASQUES AU CHARBON

Idéal pour compléter la routine de beauté hebdomadaire de la gamme DETOX, ce masque noir en fibre de charbon est imbibé d'un soin intense (pollustop® et charbon) à 91% d'origine naturelle qui agit en quelques minutes. La peau paraît alors plus nette et plus belle.

DISPLAY OF 24 CHARCOAL MASKS

The perfect way to round off your weekly beauty routine with the DETOX range, this black mask containing charcoal fibre is impregnated with 91% naturally sourced intensive care ingredients (Pollustop® and charcoal) which take effect in just minutes. It leaves your skin looking cleaner and more beautiful.

470141 - x 1

470140



470141

SplendiLift



Pour une peau plus jeune, plus lisse et plus douce, adoptez la gamme SplendiLift. L'acide hyaluronique, connu pour ses propriétés hydratantes et anti-âge, est un des composants essentiels du tissu cutané. Il confère à la peau d'importantes propriétés de résistance et d'élasticité.

For younger, smoother and softer skin, choose the SplendiLift range.

Hyaluronic acid, known for its moisturizing and anti-ageing properties, is one of the essential components of skin tissue, giving the skin considerable strength and elasticity.



CURE INTENSE 10 JOURS À L'ACIDE HYALURONIQUE

Cette cure associe 2 acides hyaluroniques de différents poids moléculaires qui permettent de maintenir l'hydratation et la tonicité de la peau. Redensifiée et réhydratée, la peau est éclatante de beauté.

10-DAY INTENSE HYALURONIC ACID TREATMENT REGIME

This skin care regimen combines 2 hyaluronic acids with different molecular weights that maintain the skin's hydration and tone. It restores your skin's density and hydration, leaving it radiant with beauty.

408240 - 10x1 ml

ÉLIXIR DE JEUNESSE À L'ACIDE HYALURONIQUE

Véritable élixir d'efficacité, ce sérum associe un complexe synergique de 3 acides hyaluroniques de différents poids moléculaires à des actifs tonifiants, hydratants, lissants et anti-âge. Visiblement défroissée, la peau gagne en éclat et les rides, ridules et marques de fatigues sont atténuées.

YOUTH ELIXIR WITH HYALURONIC ACID

This extremely effective serum combines a synergetic complex of 3 hyaluronic acids of different molecular weights with toning, moisturizing, smoothing and anti-ageing active ingredients. Your skin is visibly smoothed and more radiant, and wrinkles, fine lines and signs of fatigue fade.

408201 - échantillon / sample

408200 - 50 ml



CRÈME LISSANTE ANTI-ÂGE À L'ACIDE HYALURONIQUE

Ce concentré d'efficacité enrichi d'un complexe de 3 acides hyaluroniques agit en synergie avec des actifs anti-âge raffermissants et hydratants. Parfaitement hydratée, la peau est repulpée, les rides marquées sont lissées et le visage retrouve toute sa fermeté.

SMOOTHING ANTI-AGEING CREAM WITH HYALURONIC ACID

Rejuvenate your skin with this treatment that combines high technology with total well-being. This effective concentrated cream enriched with a complex of 3 hyaluronic acids acts in synergy with the firming and moisturizing* anti-ageing active ingredients it contains. Perfectly moisturized*, your skin fills out, marked wrinkles are smoothed and your face's original firmness is restored.

408220 - 50 ml

408221 - échantillon / sample

SOIN ANTI-RIDES YEUX À L'ACIDE HYALURONIQUE

Allié indispensable des yeux fatigués, ce soin estompe les signes du temps. Enrichi d'un complexe en acide hyaluronique reconnu pour apporter tonicité, fermeté et hydratation, il contient également un extrait d'algue à l'action anticernes et anti poches et de la Raffermine® aux propriétés lissantes et raffermissantes.

ANTI-WRINKLE EYE TREATMENT WITH HYALURONIC ACID

The best friend of tired eyes, this treatment fades the signs of ageing. Enriched with a hyaluronic acid complex known to improve tone, firmness and moisturization*, it also contains an alga extract with a dark-circle-concealing and bag-reducing action plus Raffermine®, which has smoothing and firming properties.

408211 - échantillon / sample

408210 - 15 ml



COMBLEUR DE RIDES INSTANTANÉ À L'ACIDE HYALURONIQUE

Sa texture comblante estompe instantanément les rides et ridules du visage. Grâce à l'association unique d'ingrédients ultra performants, ce soin associe résultat immédiat et efficacité à long terme.

INSTANT WRINKLE FILLER WITH HYALURONIC ACID

Its filling texture instantly fades wrinkles and fine lines on your face. Thanks to its unique combination of ultra-effective ingredients (complex of 3 hyaluronic acids, anti-ageing complex, soft focus powder, etc.), this treatment combines immediate results with lasting effectiveness.

408230 - 2,5 ml



idealift

Gamme d'exception, Idéalift révèle votre beauté en retardant les signes de l'âge sur votre visage.
6 soins complémentaires vous apportent une solution complète et efficace pour une peau plus jeune et plus dynamique.
Votre peau retrouve fermeté, éclat, et nutrition. Elle est visiblement plus lisse, plus belle et parfaitement hydratée.

The outstanding Idéalift range reveals your beauty by delaying the signs of facial ageing.

These 6 complementary treatments provide a complete and effective solution for younger-looking, more dynamic skin.
They restore your skin's firmness, radiance and nutrition, leaving it visibly smoother, more beautiful and perfectly moisturized.

GOMMAGE DOUX ANTI-ÂGE

La texture "chantilly" de ce gommage est douce et idéale pour nettoyer et exfolier la peau sans l'agresser. La peau retrouve éclat et finesse.

ANTI-AGEING GENTLE SCRUB

The 'whipped cream' texture of this scrub is wonderfully soft and ideal for cleansing and exfoliating the skin without damaging it. It restores the skin's radiance and delicate feel.

Texture crème blanche - gommage mécanique à grains fins
White cream texture - manual fine-grain scrub

408111
échantillon / sample

408110 - 50 ml



NEW

NEW



MASQUE ÉCLAT ANTI-ÂGE

Ce masque crème régénérant redonne énergie et vitalité aux peaux fatiguées. Gorgé d'actifs raffermissants, lissants et anti-fatigue qui contribuent à restructurer la peau et lui apporter de l'éclat, ce masque propose une solution complète et efficace pour apporter jeunesse et dynamisme à la peau. Le teint est frais et reposé.

ANTI-AGEING RADIANCE MASK

This regenerating cream mask restores energy and vitality to tired skin. Packed with firming, smoothing and anti-fatigue active ingredients that help restructure the skin and enhance its radiance, this mask offers a complete and effective solution for making your skin more youthful looking and dynamic, leaving your complexion fresh and rested.

Texture crème blanche / white cream texture

408120 - 50 ml

408121
échantillon / sample

SÉRUM CONCENTRÉ ANTI-ÂGE

Véritable concentré d'actifs, ce sérum vient booster l'action du soin de jour et de nuit Idéalift. Enrichi d'un lipopeptide au pouvoir raffermissant et lissant, d'un extrait végétal qui favorise la réduction des signes de fatigue pour apporter de l'éclat à la peau et d'actifs hydratants.

ANTI-AGEING CONCENTRATED SERUM

Containing a concentration of active ingredients, this serum boosts the action of Idealift day cream and night cream. Enriched with a lipopeptide with firming and smoothing properties, a plant extract that encourages fading of signs of tiredness to enhance the skin's radiance, and moisturizing active ingredients, this serum with a fluid texture strengthens and visibly repairs the skin to bring out a new youthfulness.

Texture gel transparente / clear gel texture

408131
échantillon / sample

408130 - 30 ml



NEW

CONTOUR DES YEUX ANTI-ÂGE

Retrouver un regard reposé et lumineux avec ce soin spécifique du contour de l'œil enrichi d'un peptide qui prévient et lutte contre les poches et les cernes.

ANTI-AGEING EYE CONTOUR TREATMENT

This cream, enriched with a peptide that prevents and combats bags and dark circles, is specially developed for the area around the eyes, leaving your gaze looking rested and bright.

Texture gel crème blanche - White cream gel texture

408141

échantillon / sample

408140 - 15 ml



NEW

NEW



CRÈME DE JOUR ANTI-ÂGE

À la fois préventif, protecteur et nourrissant, ce soin enrichi en huile de rosier muscat et protéines de soja ralentit les effets du temps et laisse la peau éclatante.

ANTI-AGEING DAY CREAM

Preventive, protecting and nourishing, this cream enriched with musk rose oil and soya proteins slows the effects of ageing and leaves the skin looking radiant.

Texture crème blanche / White cream texture

408150 - 50 ml

408151

échantillon / sample

CRÈME DE NUIT ANTI-ÂGE

Ce soin complet est adapté à tous les besoins des peaux matures. Il reconstitue les réserves de la peau et lui apporte les éléments nécessaires à sa régénération.

De plus, la RIGIN®, lipopeptide dont l'action est similaire à celle de la DHEA, protège l'épiderme des actions du temps.

ANTI-AGEING NIGHT CREAM

This complete treatment is tailored to the needs of mature skin. It replenishes the skin's reserves and provides it with everything it needs for new skin cell growth.

It also contains Rigin®, a lipopeptide that works in a similar way to DHEA, protecting the epidermis from the effects of time.

Texture crème blanche / White cream texture

408161

échantillon / sample

408160 - 50 ml



NEW





SOIN / CARE

SOIN DU CORPS / BODY CARE

Des soins professionnels pour un équilibre parfait entre qualité, efficacité et plaisir.
Réalisez des soins corporels sur-mesure avec des produits de qualité professionnelle pour une parenthèse beauté relaxante.
Moment d'évasion et de bien-être garanti !

Professional products that provide the perfect balance between quality, effectiveness and pleasure.
Provide tailored bodycare treatments with professional-quality products for relaxing beauty pampering sessions.
Escape and well-being guaranteed!

NEW

GEL NETTOYANT MOUSSANT VISAGE ET CORPS

Délicatement parfumé, ce gel nettoie votre peau qui retrouve douceur et confort au quotidien.

FOAMING CLEANSING GEL FOR FACE AND BODY

This delicately perfumed gel cleanses your skin, leaving it soft and comfortable from day to day.

401565 - 500 ml



GEL DOUCHE EXFOLIANT

Bien-être du corps: véritable soin du corps, la formule moussante du gel douche exfoliant, nettoie, gomme les peaux mortes laissant la peau douce, lisse et satinée.

EXFOLIATING SHOWER GEL

For body well-being: with its foaming formula, this exfoliating shower gel acts like a body treatment, cleansing and removing dead skin to leave your skin feeling soft, smooth and satiny.

Karité et huile d'argan / shea and argan oil

400075 - 150 ml

400076 - échantillon / sample

AUTHENTIQUE SAVON NOIR À L'EUCALYPTUS POUR LE CORPS

Traditionnellement utilisé dans les hammams orientaux, le savon noir est un exfoliant naturel très puissant composé d'huile d'olives et riche en vitamine E. Il prépare la peau au gommage. Débarrassée de ses impuretés, votre peau est incroyablement douce et souple.

TRADITIONAL BLACK SOAP WITH EUCALYPTUS FOR THE BODY

Traditionally used in Oriental steam baths, this black soap is a very effective natural exfoliant containing olive oil and rich in vitamin E. It prepares your skin for exfoliation. Rid of its impurities, your skin is incredibly soft and supple.

401850 - 190g

401856 - 1 kg



190g

1 Kg



GOMMAGE À GRAINS AGRUMES THÉ VERT

Ce gommage à grains élimine les impuretés pour une exfoliation tout en douceur. La peau est douce et délicatement parfumée.

CITRUS AND GREEN TEA GRAIN PEEL

This grain peel removes impurities with a very gentle exfoliating action, leaving your skin soft and delicately perfumed.

401745 - 1L

401476 - 50 ml

NEW



50 ml



1L



GOMMAGE VITAMINÉ

Enrichi en huile de noisette et beurre de karité, le gommage sucré salé apporte confort et souplesse à votre corps. Parfaitement exfoliée, votre peau est lisse, douce et soyeuse.

VITAMIN SCRUB

Enriched with hazelnut oil and shea butter, this sweet and savoury scrub makes your body feel comfortable and supple. Your skin is thoroughly exfoliated and feels smooth, soft and silky.

401550 - 250 ml

texture crème jaune orange - gommage mécanique à grains
orange yellow texture - manual grain scrub

GANT LUFFA

Éponge végétale naturelle, facile à utiliser sous la douche et pendant le bain, luttant efficacement contre la cellulite.

LOOFAH GLOVE

This natural plant sponge is easy to use in the shower or bath and is effective in combating cellulite.

160200



| MODELAGE / SCULPTING



HUILE DE MODELAGE

Riche en huile de macadamia et en huile de tournesol, cette formule est idéale pour les modelages de longue durée. S'utilise seule ou avec les complexes aux huiles essentielles Peggy Sage.

SCULPTING OIL

Rich in macadamia oil and sunflower oil, this formula is ideal for long sculpting sessions. For use on its own or with Peggy Sage essential oils complexes.

401495 - 1L

HUILE DE MODELAGE À L'HUILE ESSENTIELLE D'ORANGER

Enrichi en huile essentielle d'oranger pure et en aloe vera, ce soin permet de longs modelages en continu, décontracte, apaise le stress et défatigue le corps.

SCULPTING OIL WITH PURE ORANGE TREE ESSENTIAL OIL

"Enriched with pure orange essential oil and aloe vera, this product is for long, continuous sculpting. It relaxes, soothes stress and revives the body.

401505 - 1L

401501 - 500ml

401500 - 200ml

401502 - échantillon / Sample



1L

500ml

200ml





50 ml

250 ml

1L

CRÈME DE MODELAGE VISAGE ET CORPS

Découvrir tous les bienfaits de la relaxation et du bien-être grâce à la crème de modelage Peggy Sage. Idéale pour réaliser des modelages de longue durée, cette crème enveloppe la peau de douceur en la laissant plus souple grâce aux pouvoirs émollients de l'huile de pépin de raisin. Spécialement non parfumée, réalisez vos propres compositions à l'aide des huiles essentielles Peggy Sage.

SCULPTING CREAM FACE AND BODY

Discover all the benefits of relaxation and well-being with this Peggy Sage sculpting cream. Ideal for long sculpting sessions, this cream envelops your skin with softness, leaving it more supple thanks to the emollient properties of grape seed oil. It is perfume-free, enabling you to make your own compositions with Peggy Sage essential oils.

White cream texture

401523 - 50 ml

401520 - 250 ml

401522 - 1 L

MIEL FONDANT DE MODELAGE

Formulé à base de dérivés de sucre, ce miel fondant glisse sur la peau et ne colle pas. Sa texture unique est idéale pour les modelages longue durée car elle ne coule pas et se prête à des mouvements doux et relaxants. Il se transforme tout au long du soin : semblable à du miel il devient fondant et glisse sur la peau pour ensuite se transformer en émulsion lactée. La peau est alors facile à rincer et non grasse.

MELT-IN HONEY SCULPTING BALM

This melt-in honey balm formulated with sugar derivatives smooths onto the skin and is not sticky. Its unique texture is ideal for long-lasting sculpting massages because it does not run and is perfect for making gentle, relaxing movements. It changes through the treatment: starting with a honey-like consistency, it then smooths onto the skin, melting in, before turning into a milky emulsion. This leaves the skin easy to rinse and not oily.

401570 - 250 ml - texture miel / honey texture



BOUGIE DE MODELAGE AU THÉ VERT

Délicieusement parfumée, cette bougie se transforme en une huile tiède et onctueuse pour un moment de relaxation intense.

GREEN TEA MASSAGE CANDLE

This candle with a delightful green tea fragrance turns into a warm, smooth oil for a moment of intense relaxation.

480252 - 120 g



| COMPLEXES AUX HUILES ESSENTIELLES COMPLEX WITH ESSENTIAL OILS

COMPLEXE RELAXANT AUX HUILES ESSENTIELLES

Néroli, petit grain, lavande, marjolaine.

RELAXING COMPLEX WITH ESSENTIAL OILS

Neroli, petitgrain, lavender, marjoram.

401531 - 30 ml





COMPLEXE PURIFIANT AUX HUILES ESSENTIELLES

Géranium, romarin, ylang ylang, tea tree.

PURIFYING COMPLEX WITH ESSENTIAL OILS

Geranium, rosemary, ylang-ylang, tea tree.

401535 - 30 ml

COMPLEXE NOURRISSANT AUX HUILES ESSENTIELLES

Camomille, bois de rose, bois de santal, bois de cèdre.

VOEDEND COMPLEX MET ETHERISCHE OLIËN

Kamille, rozenhout, sandelhout, cederhout.

401532 - 30 ml



COMPLEXE ÉNERGISANT AUX HUILES ESSENTIELLES

Citron, orange, pamplemousse.

ENERGIZING COMPLEX WITH ESSENTIAL OILS

Lemon, orange, grapefruit.

401530 - 30ml



COMPLEXE RAFFERMISSANT AUX HUILES ESSENTIELLES

Orange, citron, pamplemousse, bois de santal, eucalyptus, menthe.

FIRMING COMPLEX WITH ESSENTIAL OILS

Orange, lemon, grapefruit, sandalwood, eucalyptus, mint.

401533 - 30ml

COMPLEXE AMINCISSANT AUX HUILES ESSENTIELLES

Géranium, menthe, sauge officinale, mélisse.

SLIMMING COMPLEX WITH ESSENTIAL OILS

Geranium, mint, sage, lemon balm.

401534 - 30ml



ENVELOPPEMENTS / WRAPS



RASSOUL

Argile 100% naturelle provenant du Maghreb, le rassoul possède des propriétés absorbantes et astringentes. Le rassoul est recommandé pour tous les types de peaux.

RHASSOUL MUD

Rhassoul mud is a 100% natural clay from North Africa that has absorbing and astringent properties. Rhassoul mud is recommended for all skin types.

440180 - 2 kg - texture boue / mud texture

ENVELOPPEMENT RELAXANT À LA NOIX DE COCO

Enrichi en pulpe de noix de coco aux propriétés relaxantes, ce soin enveloppe le corps d'une crème gourmande et onctueuse. Ce délicieux moment de bien-être vous plongera dans un éden de douceur.

RELAXING COCONUT WRAP

Enriched with coconut pulp which has nourishing and relaxing properties, this treatment envelops the body in a luxurious, smooth cream. Enjoy a delightful feeling of well-being with this wrap, which carries you off to a soothing Eden and leaves your skin perfectly nourished.

440170 - 6 x 250 g - texture crémeuse / creamy texture



5 Kg

BOUE AUTO CHAUFFANTE - ENVELOPPEMENT POUDRE

Sa texture poudre se mélange facilement avec de l'eau afin d'obtenir une texture chauffante et active. Cette boue est riche en spiruline, lithothamne et algues micronisées.

SELF-HEATING MUD - POWDER WRAP

Its powdery consistency mixes easily with water to produce an active heating mud. The perfect thalassotherapy treatment, this mud is rich in spirulina, lithotham and micronized algae which have detoxifying and remineralizing properties.

440175 - 5 x 250 g

440177 - 5 Kg

ENVELOPPEMENT CHAUFFANT AU THÉ VERT

Cet enveloppement crémeux est formulé à partir de jeunes feuilles de thé vert. La température monte progressivement durant le soin en libérant les ingrédients actifs. Son effet chauffant progressif et son effervescence naturelle apportent bien-être et relaxation.

WARMING GREEN TEA WRAP

This creamy wrap is formulated with young green tea leaves. The temperature gradually increases during the treatment, releasing the active ingredients. Its gradual warming effect and natural effervescence induce a feeling of well-being and relaxation.

440150 - 6 x 250 g - texture crémeuse / Crèmetextuur





BOUE MARINE

Cette boue marine est un véritable trésor de la mer. Riche en minéraux marins et oligo-éléments, elle est composée de fucus et de lithothamne, algues riches en calcium, magnésium, fer et autres minéraux.

SEA MUD

This sea mud is your sunken beauty treasure. Rich in marine minerals and oligo-elements, it also contains fucus and lithothamnion, algae that are rich in calcium, magnesium, iron and other minerals.

440191 - 5x200g

440192 - 5Kg



NEW



5Kg



NEW



5Kg

ENVELOPPEMENT MINCEUR

Idéal pour les cures minceur, cet enveloppement pelliculable procure tous les bienfaits recherchés pour affiner sa silhouette!

SLIMMING WRAP

This peel-off wrap is ideal for slimming programmes, providing all the desired slimming benefits!

Texture coagulable / coagulable texture

440160 - 6x250g

440162 - 5Kg

HYDRATANT / NOURRISSANT HYDRATING / NOURISHING



150ml

500ml

1L

LAIT HYDRATANT À LA VANILLE DES ÎLES

Délicatement parfumé à la vanille des îles, ce lait pour le corps à la texture fondante et non grasse pénètre rapidement et apporte un confort immédiat.

MOISTURIZING BODY MILK WITH SOUTH SEA ISLAND VANILLA

Delicately perfumed with south sea island vanilla, this body milk with a non-oily melt-in texture is rapidly absorbed and makes your skin instantly comfortable. With its rich formula it leaves your skin soft and hydrated all day long.

400990 - 150ml

401000 - 500ml

401050 - 1L

400991 - échantillon / sample

LAIT ULTRA-NOURRISSANT AU KARITÉ ET HUILE D'ARGAN

Succombez au plaisir de ce lait ultra nourrissant qui redonne confort et souplesse à la peau. Enrichi en beurre de karité, huile d'argan et huile d'amande douce, votre peau est intensément nourrie et hydratée.

ULTRA-NOURISHING BODY MILK WITH SHEA AND ARGAN OIL

Give in to the pleasure of this ultra-nourishing body milk that makes your skin feel comfortable and supple once again. Enriched with shea butter, argan oil and sweet almond oil, your skin is intensely nourished and hydrated. This body milk is quickly absorbed and doesn't leave behind an oily film.

401060 - 150ml

401061 - 500ml

401065 - 1L

401063 - échantillon / sample



150ml

500ml

1L



150ml

500ml

LAIT CORPS HYDRATATION EXTRÊME

Une peau douce : ce lait pour le corps apporte à votre peau une hydratation extrême. Enrichie à l'huile de noix de macadamia - arbre tropical des îles Hawaiï - et en beurre de karité, cette émulsion enveloppe votre corps d'une douceur extrême.

EXTREME MOISTURIZATION BODY MILK

For soft skin: this body milk provides your skin with some extreme hydration. Enriched with macadamia nut oil - from a tropical tree that grows on Hawaii - and shea butter, this emulsion envelops your body with a feeling of extreme softness.

401070 - 150ml

401072 - 500ml

401073 - échantillon / sample



TALC PARFUMÉ POUR LE CORPS

Ce talc d'une finesse extrême, enveloppe le corps d'un voile de douceur délicieusement parfumé à la vanille.

SCENTED BODY TALCUM POWDER

This extremely delicate talcum powder leaves the body with a soft and deliciously vanilla scented veil.

401900 - 125 ml



| SOINS SPÉCIFIQUES / SPECIFIC CARE



GEL RAFFERMISSANT MINCEUR

Le gel raffermissant Peggy Sage vous aide à atteindre votre objectif minceur. Ce gel de coloration naturelle, laisse la peau douce et tonique.

FIRMING GEL

Peggy Sage firming gel helps you reach your slimming objective. This naturally coloured gel leaves your skin feeling soft and toned.

Texture gel transparente / yellow clear gel texture

401700 - 150 ml

401702 - échantillon / sample

GEL MINCEUR THERMOACTIF

Utilisée quotidiennement, le gel minceur thermoactif va vous aider à retrouver votre silhouette. L'efficacité de ce gel est renforcée par un agent chauffant.

THERMOACTIVE SLIMMING GEL

This warming treatment combines the lipolytic properties of caffeine with a unique selection of slimming active ingredients that encourage the elimination of excess fat, reduce the appearance of orange peel skin and firm the skin.

Texture gel transparente bleue / blue clear gel texture

401721 - échantillon / sample

401720 - 150 ml



CRÈME MODELAGE MINCEUR
Utilisée quotidiennement, la crème de modelage minceur aux 8 plantes actives va vous aider à retrouver votre silhouette.

CONTOUR-FIRMING SCULPTING CREAM
Used daily, this contour-firming sculpting cream containing 8 active plant extracts will help you achieve a slimmer figure.

Texture crème jaune orange / yellow/orange cream texture

401580 - 150 ml

401581 - 250 ml

401584 - 500 ml

401582 - échantillon / sample



150 ml



250 ml



500 ml



1 L



200 ml

LOTION FRAÎCHEUR JAMBES LÉGÈRES

Station debout ou assise prolongée, chaleur, sédentarité... Vos jambes sont fatiguées, gonflées. La lotion fraîcheur assure un soulagement instantané, délasse et rafraîchit durablement.

COOLING LOTION FOR TIRED LEGS

This cooling lotion provides instant relief thanks to the action of menthol, which relaxes and refreshes your legs for a long time. This product dilutes in water and is for use together with the application of crepe bandages soaked in the solution.

440405 - 1 L

440400 - 200 ml

2 BANDES DE CRÊPES

Les bandes de crêpes s'utilisent avec la lotion fraîcheur jambes légères 440405. Pur coton, tissu élastique.

2 CREPE BANDAGES

These crepe bandages are for use with cooling lotion for tired legs 440405. Pure cotton, elastic fabric.

170045 - 0,20 x 4 m





CRÈME DÉCOLORANTE

Face and body. For fast, effective and gentle bleaching of hair and down. The two creams are used together.

BLEACHING CREAM

Gezicht en lichaam. Voor snel, efficiënt en zacht blonden van kleine haartjes. De twee crèmes worden in aanvulling op elkaar gebruikt.

600000 - 2 x 30 ml

600010 - 2 x 150 ml

NEW



GEL HYDRATANT POUR IONOPHORÈSE VISAGE ET CORPS

Pour appareil à ionophorèse, le courant galvanique va permettre de booster l'effet des principes actifs dans les couches superficielles de l'épiderme grâce à la dissociation d'ions.

HYDRATING GEL FOR IONOPHORESIS - FACE AND BODY

For use with an iontophoresis device. The galvanic current boosts the effect of the active ingredients on the upper layers of the epidermis through the dissociation of ions.

440411 - 500 ml

| ÉVASION PARFUMÉE

Nettoyer, exfolier, hydrater et protéger votre corps avec la gamme Évasion Parfumée qui se décline en 6 parfums gourmands et addictifs pour des soins adaptés à vos envies !

Cleanse, exfoliate, moisturize and protect your body with the Fragrant Escape range, which comes in 6 delicious and addictive fragrances to suit your mood!

GEL DOUCHE

Déclinés dans 6 senteurs fruitées et gourmandes, ces gels douche offrent une mousse onctueuse et délicate qui laisse la peau fraîche, parfumée et incroyablement douce.

SHOWER GEL

Available in 6 deliciously fruity fragrances, these shower gels create a delicate, creamy foam that leaves your skin fresh, perfumed and incredibly soft.

échantillon / Warenprobe

100ml

310ml

NEW



AGRUMES / THÉ VERT CITRUS / GREEN TEA

401940
100ml

401941
échantillon / sample

401943
310ml



GRENADE / PAPAYE POMEGRANATE / PAPAYA

401945
100ml

401946
échantillon / sample

401948
310ml



MANGUE / PASSION MANGO / PASSION FRUIT

401950
100ml

401951
échantillon / sample

401953
310ml



MONOÏ / TIARÉ MONOI / TIARÉ

401955
100ml

401956
échantillon / sample

401958
310ml



FLEURS DE CERISIER CHERRY BLOSSOM

401960
100ml

401961
échantillon / sample

401963
310ml



NOIX DE COCO COCONUT

401965
100ml

401966
échantillon / sample

401968
310ml

NEW

GOMMAGE

Exfolier efficacement votre peau avec ces gommages corps qui se déclinent en 6 parfums gourmands et addictifs pour une peau plus belle et plus douce.

SCRUB

Exfoliate your skin thoroughly with these body scrubs in 6 deliciously addictive fragrances for softer, more beautiful skin.

100 ml

300 ml

échantillon / sample



AGRUMES / THÉ VERT CITRUS / GREEN TEA

401970
100 ml

401971
échantillon
sample

401973
300 ml



GRENADE / PAPAYE POMEGRANATE / PAPAYA

401975
100 ml

401976
échantillon
sample

401978
300 ml



MANGUE / PASSION MANGO / PASSION FRUIT

401980
100 ml

401981
échantillon
sample

401983
300 ml



MONOÏ / TIARÉ MONOI / TIARÉ

401985
100 ml

401986
échantillon
sample

401988
300 ml



FLEUR DE CERISIER CHERRY BLOSSOM

401990
100 ml

401991
échantillon
sample

401993
300 ml



NOIX DE COCO COCONUT

401995
100 ml

401996
échantillon
sample

401998
300 ml





CRÈME MAINS ET CORPS PARFUMÉE

Chouchouter vos mains et votre corps avec ces délicieuses crèmes parfumées. Leurs textures ultra sensorielles et fondantes au beurre de karité hydratent et prennent soin des mains et du corps au quotidien, sans laisser de fini gras ni collant.

HAND & BODY CREAM

Pamper your hands and body with these delicious perfumed creams. Their ultra-sensual, melt-in textures containing shea butter moisturize and nurture your hands and body from day to day without leaving behind an oily or sticky film.

30 ml

125 ml

NEW

300 ml

échantillon / sample

AGRUMES / THÉ VERT CITRUS / GREEN TEA

120360
30 ml

401080
125 ml

120366
échantillon / sample

401910
300 ml



30 ml



125 ml



300 ml



30 ml



125 ml



300 ml

GRENADE / PAPAYE POMEGRANATE / PAPAYA

120361
30 ml

401081
125 ml

120367
échantillon
sample

401911
300 ml



30 ml



125 ml



300 ml

MANGUE / PASSION MANGO / PASSION FRUIT

120362
30 ml

401082
125 ml

120368
échantillon / sample

401912
300 ml



30 ml



125 ml



300 ml



MONOI / TIARÉ
MONOI / TIARÉ

120364
30 ml

401083
125 ml

120370
échantillon / sample

401913
300 ml



30 ml

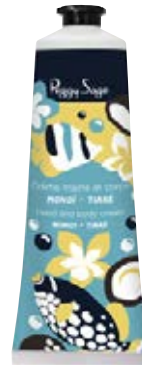

125 ml



300 ml



30 ml



125 ml



300 ml

FLEUR DE CERISIER
CHERRY BLOSSOM

120372
30 ml

401084
125 ml

120373
échantillon
sample

401914
300 ml

NOIX DE COCO
COCONUT

120378
30 ml

401085
125 ml

120379
échantillon / sample

401915
300 ml



30 ml



125 ml



300 ml

Lagoon island



Véritable instant de détente, Lagoon island vous invite pour un voyage aux limites des sens qui procure un moment de bien-être absolu, pour le corps et pour l'esprit.

Décollage immédiat dans les contrées lointaines de la Polynésie, cette ligne vous procure un dépaysement total et une sensation unique de bien-être en enveloppant votre corps d'odeurs subtiles aux parfums chauds et gorgés de soleil qui vous feront voyager très loin des tracas du quotidien.

Lie back and relax: LAGOON ISLAND will whisk you away on a journey to the edge of your senses in a moment of complete wellbeing for both body and mind.

Departing immediately for far-off Polynesia, this line treats you to a totally exotic and unique sensation of well-being, enveloping your body in subtle scents and sun-kissed fragrances that will spirit you far away from the hassles of everyday life.



500ml

200ml

MERVEILLEUX GOMMAGE POUR LE CORPS

Ambiance du bout du monde, ce gommage couleur lagon à la texture parsemée de grains de sable noir et de coques de noix de coco exfolie et affine le grain de peau. Enveloppée d'un parfum à la fois solaire et frais, et enrichie d'eau florale de mangue, de goyave et de papaye, votre peau est lumineuse et soyeuse, prête à recevoir les bienfaits des soins pour le corps Lagoon island.

FABULOUS BODY SCRUB

This enticingly exotic lagoon-blue textured body scrub contains rains of black sand and coconut shell that exfoliate and refine the skin grain. Enveloped in a fresh, sun-kissed fragrance and enriched with mango, guava and papaya blossom water, your skin is bright and silky, and ready to be treated to the benefits of the Lagoon Island bodycare products.

480200 - 200 ml

480205 - 500ml

480201 - échantillon / sample

BOUGIE DE MODELAGE

Cette bougie au parfum chaud et gorgé de soleil se transforme en une huile tiède et onctueuse pour un moment de relaxation intense.

SCULPTING CANDLE

This candle with a warm, sun-drenched fragrance turns into a warm, smooth oil for a moment of intense relaxation.

480250 - 120g



LAIT ENSOLEILLANT POUR LE CORPS - HÂLE PROGRESSIF

Enrichi en huile de coco, beurre de mangue, extrait de goyave et vitamine E, ce lait pour le corps à la texture fondante et non grasse pénètre rapidement et apporte un confort immédiat.

BRONZING BODY MILK - GRADUAL TAN

This body milk gives your skin a gradual, even and ultra-natural-looking bronzed look. Enriched with coconut oil, mango butter, guava extract and vitamin E, it has a non-oily melt-in texture that penetrates quickly for an immediate feeling of comfort.

480211 - échantillon / sample

480210 - 150 ml



DIVINE HUILE SÈCHE POUR LE CORPS

Tel un secret de beauté polynésien, cette huile sèche associe le pouvoir nutritif de l'huile de coco et du monoi de Tahiti pour redonner souplesse et douceur à la peau. Délicatement parfumée, elle vous procurera une sensation unique de bien-être et enveloppera votre corps d'un voile parfumé au doux parfum de vacances.

DIVINE DRY BODY OIL

Like a Polynesian beauty secret, this dry body oil combines the nutritive properties of coconut oil and Monoi de Tahiti, restoring your skin's suppleness and softness. Delicately perfumed, it gives you a unique feeling of well-being and envelops your body in a subtly fragrant sheen with an exotic holiday air.

480220 - 125 ml

480221 échantillon / sample

EAU DE SOIN SUBLIMATRICE POUR LE CORPS RAFRAÎCHISSANTE ET PARFUMÉE

Enveloppez votre corps avec cette eau de soin parfumée, gorgée de soleil et de vitalité. En un seul geste, l'eau de soin, composée d'eau de mangue et d'extrait de goyave, parfume délicieusement la peau et vous plonge dans un éden de fraîcheur. Votre peau est tonifiée, douce et délicatement parfumée.

BEAUTIFYING TONIC WATER FOR THE BODY REFRESHING AND FRAGRANT

Envelop your body in this fragrant tonic water, packed with sun and vitality. In one go, this tonic water containing mango blossom water and guava extract wraps your skin in a delicious fragrance and envelops you in an Eden of freshness.

480230 - 200 ml



HUILE DE MODELAGE CORPS À L'HUILE DE FLEUR DE LA PASSION

Véritable instant de détente, cette huile de modelage parfumée à la fleur de tiaré vous invite pour un voyage au-delà des sens. Composée d'huile de fleur de la passion, d'huile de coco et d'huile de tournesol, ce soin procure un moment de bien-être absolu, pour le corps et pour l'esprit.

BODY SCULPTING OIL

This sculpting oil fragranced with Tahitian gardenia blossom takes you on a wonderfully relaxing journey beyond the realm of the senses. Containing passion fruit flower oil, coconut oil and sunflower oil, this product induces a feeling of total well-being for both body and mind.

480241 - échantillon / sample

480240 - 500 ml





Invitation aux rituels de beauté... Partagez tous les secrets de la femme orientale avec la gamme Fleur d'orient.

Partez à la découverte des bienfaits de ces soins de qualité qui s'organisent autour des gestes traditionnels du hammam.

An invitation to partake in the rituals of beauty... Share all the secrets of oriental women with the Fleur d'orient range.

Set out to discover the benefits of these quality products which are based on the traditional treatments of the oriental steam bath. To make these pleasurable moments a unique experience... create a warm atmosphere by lighting the delightfully perfumed orange blossom candle.



AUTHENTIQUE SAVON NOIR À L'EUCALYPTUS POUR LE CORPS

Traditionnellement utilisé dans les hammams orientaux, le savon noir est un exfoliant naturel très puissant composé d'huile d'olives et riche en vitamine E. Il prépare la peau au gommage. Débarrassée de ses impuretés, votre peau est incroyablement douce et souple.

TRADITIONAL BLACK SOAP WITH EUCALYPTUS FOR THE BODY

Traditionally used in Oriental steam baths, this black soap is a very effective natural exfoliant containing olive oil and rich in vitamin E. It prepares your skin for exfoliation. Rid of its impurities, your skin is incredibly soft and supple.

401850 - 190g

GANT DE KESSA

S'utilise avec le savon noir à l'eucalyptus Peggy Sage pour une peau incroyablement douce et lisse. Lavable en machine à 60°C.

KESSA GLOVE

For use with the Peggy Sage black soap for incredibly soft and smooth skin. Machine-washable at 60°C.

160210



HUILE DE MODELAGE POUR LE CORPS

Inspirée de la tradition orientale, cette huile de modelage au parfum enivrant de fleur d'oranger vous assure un moment de bien-être absolu. Enrichi en huile d'argan, d'abricot, de tournesol et de cumin noir aux vertus nourrissantes, cet élixir distille sur votre peau ses trésors de beauté et de douceur.

BODY SCULPTING OIL

Inspired by Oriental tradition, this sculpting oil with its intoxicating orange-blossom perfume will treat you to a moment of complete well-being. Enriched with argan, apricot, sunflower and black cumin oils with nourishing properties, this elixir blesses your skin with its precious properties of beauty and softness.

401886 - échantillon / sample

401885 - 500 ml



HUILE SÈCHE POUR LE CORPS À LA FLEUR D'ORANGER & HUILE D'ARGAN

Subtil mélange d'huile d'argan, d'abricot et de tournesol aux vertus hydratantes et adoucissantes, cette huile laisse la peau délicieusement satinée.

DRY BODY OIL WITH ORANGE BLOSSOM & ARGAN OIL

Beautify your skin with this dry body oil with its warm exhilarating aroma of orange blossom. A subtle mixture of argan, apricot and sunflower oils with moisturizing and softening properties, this oil leaves your skin delightfully satin-smooth.

401860 - 150 ml

401861 - échantillon / sample

LAIT HYDRATANT POUR LE CORPS À LA FLEUR D'ORANGER & HUILE D'ARGAN

Inspiré des secrets de beauté orientale, ce lait velouté et soyeux laisse sur la peau une douce caresse parfumée. Enrichie en huile d'argan et beurre de karité, sa texture onctueuse et riche enveloppe votre peau d'un voile de douceur et lui apporte confort toute la journée.

MOISTURIZING BODY MILK WITH ORANGE BLOSSOM & ARGAN OIL

Inspired by the secrets of Oriental beauty, this velvet-smooth, silky body milk leaves a gossamer-soft fragrance on your skin. Enriched with argan oil and shea butter, its creamy, rich texture envelops your skin with a veil of softness, leaving it feeling comfortable all day long.

401870 - 150 ml

401871 - échantillon / sample

BOUGIE DE MODELAGE À LA FLEUR D'ORANGER

Délicieusement parfumée, cette bougie se transforme en une huile tiède et onctueuse pour un moment de relaxation intense.

ORANGE BLOSSOM SCULPTING CANDLE

This candle with a delightful orange blossom fragrance turns into a warm, smooth oil for a moment of intense relaxation.

480251 - 120 g





SUN AC



GRAISSE À TRAIRE AU MONOI DE TAHITI

À base de monoi, huile adoucissante et bronzante, et de beurre de karité réputé pour ses vertus antidesséchantes, la graisse permet un bronzage intense et rapide. Sans indice de protection, ne convient pas aux peaux sensibles et fragiles

MONOI DE TAHITI MILKING GREASE

Made with monoi, a softening and tanning oil, and shea butter, well known for its anti-dehydrating properties, this balm gives a fast, intense tan. It has a zero sun protection factor and is not suitable for sensitive and fragile skins.

405110 - 150 ml

HUILE SOLAIRE AU MONOI DE TAHITI

Cette huile au monoi permet un bronzage intense et rapide et évite le dessèchement de la peau et des cheveux grâce à ses propriétés adoucissantes. Sans indice de protection, ne convient pas aux peaux sensibles et fragiles.

MONOI DE TAHITI SUN OIL

This monoi oil is for fast, intense tanning. Its softening properties prevent the skin and hair from drying out. It has a zero sun protection factor and is not suitable for sensitive and fragile skins.

405100 - 100 ml



CRÈME AUTOBRONZANTE TEINTÉE VISAGE ET CORPS

Sa formule teintée rend la peau soyeuse et donne une couleur dorée naturelle sans les méfaits du soleil.

TINTED SELF-TANNING CREAM FOR FACE AND BODY

Its tinted formula gives the skin a silky feel and a natural-looking golden colour without exposure to the harmful effects of sunlight.

405051 - échantillon /sample

405050 - 150 ml



LOTION BRONZANTE INSTANTANÉE

Habille visage et corps d'un reflet bronzé immédiat.

INSTANT TANNING LOTION

Instantly dress up face and body with the look of natural suntan.

405030 - 100 ml



GANT APPLICATEUR POUR PRODUITS BRONZANTS VISAGE ET CORPS

Permet une application parfaite et sans trace de vos produits bronzants Peggy Sage.

APPLICATOR MITT FOR TANNING PRODUCTS FACE AND BODY

For perfect, streak-free application of your Peggy Sage tanning products.

160205

HUILE SÈCHE PAILLETÉE CORPS

Cette huile sèche sublime l'éclat de la peau et des cheveux en les enveloppant d'un voile satiné délicatement parfumé.

BODY OIL WITH GLITTER

This dry oil enhances your skin's and hair's radiance by enveloping them in a delicately perfumed light satin covering.

403303 - 50 ml

CRÈME SCINTILLANTE POUR LE CORPS

Offrez à votre peau la douceur d'une crème onctueuse et fondante qui enveloppe votre corps d'une poussière d'étoiles délicatement parfumée.

SPARKLING BODY CREAM

This light, smooth cream brightens your skin and gives it a subtle sparkle. It enhances your skin, leaving it soft, bright and delightfully perfumed.

403301 - échantillon / sample

403300 - 200 ml





SOIN / CARE

SOIN POUR HOMME / MEN'S SKINCARE

Une gamme de soins d'exception spécialement élaborée pour les hommes.
Pour les hommes pressés et soucieux de leur bien-être, Peggy Sage propose une gamme de soins visage et corps
pour les besoins spécifiques des peaux masculines.

A range of exceptional skincare treatments developed especially for men.
For men with a busy life who care about their well-being, Peggy Sage offers a range of facial and body care products tailored
specifically to the needs of men's skin.

GEL DOUCHE ÉNERGISANT CORPS ET CHEVEUX

On se réveille !

Réveillez-vous du bon pied avec le gel douche énergisant Peggy Sage. Agréablement parfumé, ce gel douche 2-en-1 nettoie en douceur corps et cheveux. Il rend les cheveux souples et faciles à coiffer.

ENERGIZING SHOWER GEL FOR BODY AND HAIR

Your wake-up call

Your wake-up call. Start the day on the right foot with Peggy Sage energizing shower gel. This pleasantly fragranced 2-in-1 shower gel gently cleans your hair and body, leaving your hair soft and easy to style.

430301 - échantillon / sample

430300 - 200 ml



GEL NETTOYANT VISAGE

Nec plus ultra

Formulé à base d'extrait de sauge, d'orchidée noire et de menthe poivrée, ce soin nettoie le visage en douceur. La peau est propre et débarrassée des impuretés. Idéal pour préparer la peau au rasage.

CLEANSING FACE GEL

The ultimate cleanser

Formulated with sage extract, black orchid and peppermint, this gel cleanses your face gently, leaving your skin clean and free of impurities. The ideal way to prepare the skin for shaving.

430310 - 100 ml

430311 - échantillon/ sample

GEL EXFOLIANT DÉSINCROUSTANT VISAGE

Zéro défaut

Pour une peau nettoyée et sans défaut. Associant les vertus du zinc, de la sauge, de l'orchidée noire et de la menthe poivrée, ce gel exfoliant élimine les impuretés, affine le grain de peau et prépare la peau au rasage.

EXFOLIATING FACIAL SCRUB

For perfect skin

For faultless, cleansed skin. Combining the properties of zinc, sage, black orchid and peppermint, this exfoliating gel removes impurities, refines the skin grain and prepares your skin for shaving.

430321 - échantillon / sample

430320 - 100 ml





GEL DE RASAGE HAUTE-PROTECTION

Pile poil

Ce gel de rasage haute-protection se transforme en une mousse ultra-dense et onctueuse qui protège efficacement votre peau.

HIGH-PROTECTION SHAVING GEL

Your cleanest shave yet

This high-protection shaving gel turns into a creamy, ultra-dense foam that protects your skin effectively.

430330 - 150ml



FLUIDE APRÈS RASAGE APAISANT

Pare feu

Ce fluide non gras calme le feu du rasoir et procure un confort idéal après chaque rasage. La peau est douce et souple.

SOOTHING AFTERSHAVE FLUID

Quench the fire

This non-oily fluid calms your face after shaving and gives you a perfect feeling of comfort after every shave, leaving your skin soft and smooth.

430340 - 100ml

430341 - échantillon / sample

SOIN HYDRATANT ANTI-BRILLANCE

L'arme fatale

Ce gel a une double action hydratante et matifiante. Sa texture fluide et légère pénètre immédiatement sans effet gras, pour une peau propre et nette tout au long de la journée.

ANTI-SHINE MOISTURIZE

Lethal weapon

This gel has a twin hydrating and mattifying action. Its light, fluid texture penetrates immediately leaving no greasy feeling to give you clean, clear skin all day long..

430351 - échantillon / sample

430350 - 50 ml



SOIN ANTI RIDES VISAGE ET YEUX

Beau comme hier

Ce soin 100% homme a été élaboré avec des actifs ultra performants pour combattre les signes de l'âge. Progressivement, les traits sont lissés et le visage retrouve l'éclat de sa jeunesse.

ANTI-WRINKLE TREATMENT FOR FACE AND EYES

Roll back the years

This 100% men's product contains ultra-effective active ingredients to combat the signs of ageing. Its exclusive formula provides an all-in-one treatment that acts against wrinkles and slackening of the skin. Gradually, lines are smoothed out and your face will regain its bright, youthful look.

430360 - 50ml

430361 - échantillon / sample

DÉODORANT ROLL ON ANTI TRANSPIRANT

Mon garde du corps

Soyez sûr de vous avec cet antiperspirant.

ROLL-ON ANTIPERSPIRANT DEODORANT

Your personal bodyguard

You can have confidence in this antiperspirant.

430370 - 50ml









VOUS ACCOMPAGNER GRÂCE À DU MATÉRIEL PRÉMIUM SPÉCIALEMENT CONÇU POUR LES PROFESSIONNELS



Le secret d'une prestation parfaitement réalisée réside également dans la qualité du matériel et des accessoires que vous utiliserez. Choisissez l'excellence avec Peggy Sage. Répondez aux exigences de vos clients en leur apportant sécurité et confort avec nos équipements de qualité.



SUPPORTING YOU IN YOUR WORK WITH PREMIUM EQUIPMENT DESIGNED ESPECIALLY FOR PROFESSIONALS



The secret of perfectly executed beauty treatments is also down to the quality of the equipment and accessories you use. Choose excellence with Peggy Sage. Give your clients what they want while ensuring their comfort and safety with our high-quality equipment.

MATÉRIEL D'INSTITUT SALON EQUIPMENT	368
MOBILIER D'INSTITUT SALON FURNITURE	385
BAGAGERIE / LUGGAGE	388

MATÉRIEL MARKETING MARKETING EQUIPMENT	391
PRÉSENTOIRS / DISPLAYS	394
PRÉSENTOIRS MODULABLES MODULAR DISPLAYS	396

| MATÉRIEL D'INSTITUT / SALON EQUIPMENT



COUSSIN MANUCURE BLANC ET HOUSSE

80% coton / 20% polyester. Livré avec une housse supplémentaire.
Lavable en machine à 30°C.

WHITE MANICURE CUSHION AND COVER

80% cotton / 20% polyester. Supplied with an extra cover.
Machine washable at 30°C.

160016 - 25x20 cm

HOUSSE ÉPONGE POUR LIT D'ESTHÉTIQUE

80% coton / 20% polyester. Lavable en machine à 30°C.

TERRY TOWEL SALON COUCH COVER

80% cotton, 20% polyester. Machine-washable at 30°C.

160350 - 193x91x15 cm



COUSSIN REPOSE-MAIN

100% coton

HANDREST CUSHION

100% cotton

160020 - 30 x 15 x 8 cm - blanc / white

REPOSE-MAIN DESIGN

DESIGN HAND-REST

160150



BOÎTE DE RANGEMENT MANUCURE GM

Idéale pour ranger limes, pinceaux et tout votre petit matériel.

MANICURE STORAGE BOX, SIZE L

Ideal for storing nail files, brushes and all your accessories.

155341 - 23 x 14,8 x 4,2 cm - livrée vide / supplied empty



BOÎTE DE RANGEMENT MANUCURE

Avec un plateau à compartiments amovible.

MANICURE STORAGE BOX

With removable compartmentalised tray.

155340 - 21,8 x 6,2 x 3,6 cm - livrée vide / supplied empty

SET DE RANGEMENT POUR GELS UV 5 ET 15 G

2 mousses de calage pour 4 pots de gel UV 15 g et 5 pots de 5 g.
S'adaptent parfaitement à la boîte de rangement manucure 155341.

TIDY SET FOR 5 G AND 15 G UV NAIL GELS

Two foam inserts for 4 x 15 g UV gel pots and 5 x 5 g UV gel pots.
Fits perfectly inside the manicure storage box 155341.

200205



BAC DE DÉSINFECTION

Pour désinfecter des instruments et petit matériel de manucure/pédicure.
Dimensions du plateau intérieur : 19 x 7,5 cm.

DISINFECTING CONTAINER

For disinfecting manicure/pedicure instruments and accessories.
Dimensions of internal tray: 19 x 7.5 cm.

147100 - 22,5 x 12 x 7 cm - livré vide / supplied empty



155400

50 SERVIETTES MANUCURE

Assurent une hygiène parfaite à chaque nouvelle cliente.

50 MANICURE TOWELS

Ensure perfect hygiene for every new client.

155400 - x50 - 30 x 42 cm



155403

50 SETS MANUCURE JETABLES PLASTIFIÉS

Hygiène et propreté assurée à chaque cliente. Sets manucure revêtus d'un film plastique afin de protéger votre espace de travail de toute coulure de gel, colle, vernis ou autre liquide. Très pratique lors de vos prestations à domicile.

50 DISPOSABLE PLASTIC-COATED MANICURE MATS

Hygiene and cleanliness for every client. Manicure mats coated with a plastic film to protect your workspace from spills of gel, glue, nail lacquer and other liquids. Very practical for home services.

155403 - x50 - 30 x 40 cm

ORGANISEUR MANUCURE

Tout le matériel professionnel à portée de main : plusieurs compartiments très pratiques et un distributeur de formes pour un espace de travail soigné et optimisé.

MANICURE ORGANIZER

Keep all your professional equipment to hand: several very practical compartments and a form dispenser for presenting your work space in a tidy and optimized way.

140014 - 15,4 x 15,6 x 14,4 cm - livré vide / supplied empty



PLATEAU MANUCURE PROFESSIONNEL

Transparent et pratique : tous les compartiments pour ranger parfaitement le petit matériel de manucure et avoir une présentation toujours impeccable. Plexiglas.

PROFESSIONAL MANICURE TRAY

Transparent and practical: with all the necessary compartments for small manicure equipment, and for an impeccable presentation at all times. Plexiglas.

155355 - 18,4 x 37,5 x 12,5 cm - livré vide / supplied empty

LOT 2 ROULEAUX DE 500 CARRÉS DE CELLULOSE
PACK OF 2 ROLLS OF 500 CELLULOSE SQUARES

155450 - 2x 500 - 1 carré / square = 5 x 4 cm



BOÎTE DE 50 MASQUES DE PROTECTION

Jetables, hygiéniques et confortables. Protègent contre l'inhalation de poussière d'ongle.

BOX OF 50 PROTECTIVE MASKS

Disposable, hygienic and comfortable. Protect the wearer from inhaling nail dust.

170070 - x50

LUNETTES DE PROTECTION

Légères, résistantes et confortables. Protègent des projections et de la poussière.

SAFETY GLASSES

Light, hardwearing and comfortable. Protect the wearer from projections and dust.

170080



1 PAIRE DE GANTS NYLON MANUCURE

Lavables, idéals pour une utilisation quotidienne. Protègent vos doigts et vos ongles grâce à leurs extrémités renforcées.

1 PAIR OF NYLON MANICURE GLOVES

Washable, ideal for everyday use. Reinforced tips protect your fingers and nails.

170095 - taille unique / One size fits all

POMPE POUR RÉSERVOIR DE 5 LITRES
PACK OF 2 ROLLS OF 500 CELLULOSE SQUARES
400007





KIT VOYAGE

Un kit astucieux de flacons et pots vides à remplir avec vos produits de soin ou manucure préférés lors de vos déplacements, week-ends et vols en avion* !
Ce kit contient dans une trousse zippée :
2 flacons vides 50 ml, 1 flacon spray 50 ml, 2 pots vides 10 ml, 1 spatule.

TRAVEL KIT

A handy kit of empty bottles and pots that you can fill with your favourite treatment and manicure products when you're on the move, off for the weekend or getting on a plane*!

Kit consists of zip-up bag containing:
2 empty 50 ml bottles, 1 50 ml spray bottle, 2 empty 10 ml pots, 1 spatula.

*conformes aux normes du transport aérien / contents comply with air travel requirements

200450 - 15x13x4 cm

SÈCHE-VERNIS

Permet un séchage du vernis à ongles impeccable en 15 minutes. Le sèche-vernise se met en route pendant 15 minutes en soufflant alternativement toutes les minutes de l'air chaud puis de l'air froid.
Garantie sur le matériel électrique : 2 ans.

ELECTRIC NAIL LACQUER DRYER

For a perfect nail lacquer drying in 15 minutes. The nail lacquer dryer will operate for 15 minutes, blowing hot and cold air alternately every minute.
Warranty on electrical equipment: 2 years.

155301 - 27 x 30 x 18,5 cm



MINI SÈCHE-VERNIS

Compact et design, permet d'accélérer le temps de séchage de votre vernis à ongles. Exercer une simple pression des doigts et le mini sèche-vernise se met en route. Fonctionne avec 2 piles AA non fournies. Garantie sur le matériel électrique : 2 ans

MINI NAIL LACQUER DRYER

This compact and stylish dryer speeds up your nail lacquer drying time. Simply press the top to switch on the mini nail lacquer dryer. Operates with 2 x AA batteries, not supplied. Warranty on electrical equipment: 2 years.

155299 - Ø 12 cm - H 7,5 cm

50 GANTS PROFESSIONNELS NITRILE

Non poudrés.

50 NITRILE WHITE GLOVES FOR PROFESSIONALS

Non-powdered.

170091 - M - boîte de 50 gants blancs / box of 50 gloves white

170092 - S - boîte de 50 gants noirs / box of 50 gloves black

170093 - S - boîte de 50 gants roses / box of 50 gloves pink



BOÎTE DE 1000 SERVIETTES SPÉCIALES ONGLES

Multi usage, elles ne peluchent pas.

BOX OF 1000 TOWELS SPECIAL FOR NAILS

Multi-use, lint-free.

155411 - x1000 - 4 x 5 cm



COTONS CARRÉS

Qualité esthétique. Doux et absorbants.

COTTON WOOL SQUARES

Salon quality. Soft and absorbent.

170001 - x 80 - 6 x 5 cm

170002 - x 50 - 7,5 x 7,5 cm

200 COMPRESSES MANUCURE

Multi-usage, ne peluchent pas. Douces et résistantes.

200 MANICURE WIPES

Multi-use, lint-free. Soft and strong.

155420 - x200 - 5 x 5 cm



NEW



TROUSSE POUR ÉPONGES

SPONGE BAG

200543 - 15x4,5 cm

PLATEAU PLASTIQUE PLASTIC TRAY

155356 - 36,5 x 28,5 x 1,5 cm





NEW

100 BOULES DE COTON
100 COTTON WOOL BALLS
170004

DISQUES COTON
Paquet de 80. Qualité esthétique. 100% coton.
COTTON WOOL DISCS
Pack of 80. Salon quality. 100% cotton.
170000 - x80 - 1 disque / disc Ø 6 cm



60 DISQUES POUR DÉMAQUILLER LES ONGLES

Pratiques et résistants pour retirer le vernis et nettoyer les ongles en un tour de main.

60 NAIL LACQUER REMOVAL DISCS

Practical and strong, for removing nail lacquer and cleansing nails in a trice.

155412 - x60 - 1 disque / disc Ø 4,5 cm

100 CARRÉS ABSORBANTS MANUCURE
Idéals pour nettoyer et dégraisser les ongles. Non tissés, ne peluchent pas.

100 ABSORBENT MANICURE SQUARES
Ideal for cleansing and degreasing nails. Nonwoven, lint-free.

155425 - 5x5 cm



NEW



100 PROTÈGE TROU FACIAL
100 FACE HOLE PROTECTOR
170054 - x100 - 30x40 cm

170200 - 500ml

**BOL PLASTIQUE SOUPLE
SOFT PLASTIC BOWL**

170201 - 1L



170200

170201



170210

**COUPELLE PLASTIQUE
PLASTIC DISH**

170210 - 50ml

**DOSEUR PLASTIQUE
PLASTIC MEASURING JUG**

170230 - 400ml



NEW

**MAZAGRAN
GOBLET**

170252 - H 14cm

**DUO 2 POTS ACRYLIQUE
SET OF 2 ACRYLIC POTS**

170250 - 30ml

170251 - 5ml



170250



170251

NEW



**SPATULE POUR ALGINATES
ALGINATE SPATULA**

170221 - 21cm

NEW

**FOUET
WHISK**

170234 - 20cm

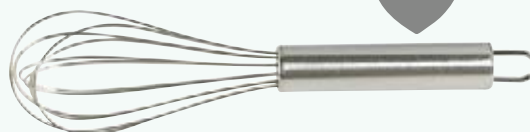



MOUCHOIRS

Boîte de 100. Qualité supérieure doux et absorbants.

TISSUES

Box of 100. Superior quality, soft and absorbent.

170010 - Dimensions du mouchoir / Tissue dimensions : 20x21 cm

POT ACRYLIQUE EN PLASTIQUE ACRYLIC BEAKER

170231 - Ø 6,6 cm / H 10 cm



NEW

NEW



HOUSSE BOITE À MOUCHOIRS

TISSUE BOX COVER

170011

DUO 2 POTS ACRYLIQUE SET OF 2 ACRYLIC POTS

170232



NEW

NEW



6 COUPELLES PYREX 6 PYREX MINI-BOWLS

170233 - Ø 6 cm

50 FEUILLES D'ENVELOPEMENT
50 WRAP SHEETS
170040 - x50 - 200x180 cm



50 COMPRESSES DE GAZE POUR MASQUES VISAGE
100% coton. Idéales pour l'application des masques spécifiques visage.
50 GAUZE COMPRESSES FOR FACIAL MASKS
100% cotton. Ideal for applying special facial masks.
170015 - x50 - 30 x 20 cm

DRAP D'EXAMEN
Largeur 50 cm, prédécoupé tous les 35 cm. 150 formats, 2 plis 19 g
PAPER LINER
Width 50 cm, pre-cut every 35 cm. 150 sections, 2-ply, 19 g.
170020 - pack de 3 rouleaux / pack of 3 rolls



HOUSE JETABLE
Non tissée. Idéale pour une protection parfaite de vos tables d'examen.
Pratique à poser avec ses élastiques d'angles.
DISPOSABLE COVER
Nonwoven. Ideal for protecting your salon couches.
Practical to fit, with elasticated corners.
170030 - x10 - 195x90 cm

DRAP D'ESTHÉTIQUE NON TISSÉ
NONWOVEN BEAUTY SALON SHEET
170035 - 200x160 cm





BROSSE VISAGE RONDE
ROUND FACE BRUSH

170240 - manche plastique / plastic handle 10 cm. Brosse / Brush Ø 3,5 x 2 cm

120200 - 15,5cm

SPATULE HYGIÉNIQUE
HYGIENIC SPATULA

120201 - x12 - 15,5cm

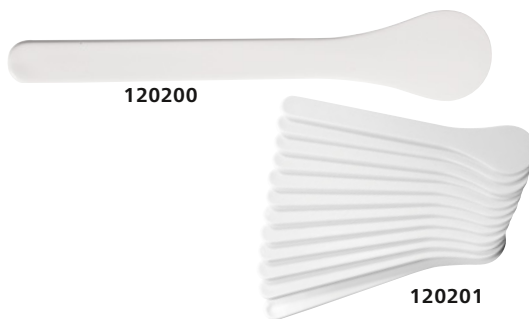

120200

120201



PINCEAU MASQUE SOIE BLANCHE

Pour les masques crème ou gel. Poils synthétiques.

WHITE SILK MASK BRUSH

For cream and gel masks. Synthetic bristles.

135129 - 25mm

SPATULE PLASTIQUE
PLASTIC SPATULA

170220 - 18cm



PINCEAU SPATULE SILICONE VISAGE

SILICONE SPATULA FACE BRUSH

135210

PINCEAU CORPS

Pour vos programmes corporels en cabine. Poils de porc.

BODY BRUSH

For salon body treatment programmes. Pig bristle.

141031 - 50mm



ÉPONGE NATURELLE POUR LE CORPS
NATURAL BODY SPONGE
120185 - Ø 10 cm



NEW



GANT EXFOLIANT X 2

Une paire de gants exfoliants pour faire mousser le gel douche, exfolier la peau en douceur et éliminer les cellules mortes. À utiliser 1 à 2 fois par semaine.

EXFOLIATING GLOVE X 2

A pair of exfoliating gloves for working shower gel into a lather, gently exfoliating and removing dead skin cells. Use once or twice a week.

160216 - 100% polyester

VANITY BLANC
Blanc. Taille unique.
VANITY CASE
White. One size fits all.
200544 - 28 x 19 x 18 cm

NEW



NEW



GANTS DE TOILETTE

70% coton

WASH MITTS

70% cotton

170111 - 16 x 22 cm

SERVIETTES BLANCHES

70% coton.

WHITE TOWELS

70% cotton.

170131
40 x 80 cm

170132
50 x 90 cm

170133
150 x 220 cm

NEW





POUBELLE DE TABLE PLASTIQUE
PLASTIC TABLE-TOP RUBBISH BIN
155380 - ø 15 x 22 cm

TAPIS DE SOL
100% coton. Lavable en machine à 30°C.

FLOOR MAT
100% cotton. Machine washable at 30°C.
170100 - 50x80 cm



DRAP DE BAIN
65% coton. 35% polyester. Lavable en machine à 30°C.
BATH TOWEL
70% cotton. 30% polyester. Machine washable at 30°C.
170120 - 70x165 cm

SERVIETTE INVITÉ
65% coton. 35% polyester. Lavable en machine à 30°C.
GUEST TOWEL
65% cotton. 35% polyester. Machine washable at 30°C.
170130 - 30x30 cm



COUVERTURE ISOTHERMIQUE
ISOTHERMAL BLANKET
170025 - 160x210 cm

TABLIER IMPERMÉABLE JETABLE

Imperméable et résistant. Blanc. Taille unique.

DISPOSABLE WATERPROOF APRON

Waterproof and strong. White. One size fits all.

170067



PARÉO BLANC

100% coton. Lavable en machine à 30°C. Taille unique.

WHITE PAREO

100% cotton. Machine washable at 30°C. One size fits all.

160320



PARÉO JETABLE

Matière non-tissée douce et résistante. Blanc. Taille unique.

DISPOSABLE PAREO

Soft and hardwearing nonwoven material. White. One size fits all.

170065



KIMONO JETABLE

Non tissé, doux et résistant. Blanc. Taille unique.

DISPOSABLE KIMONO

Nonwoven, soft and strong. White. One size fits all.

170066



BLOUSE ESTHÉTIQUE BLANCHE

76% polyester, 21 % viscose, 3% polyuréthane. Lavable en machine à 30°C.
Assortie aux pantalons 160303, 160304 et 160305.

WHITE BEAUTICIAN'S JACKET

76% polyester, 21 % viscose, 3% polyuréthane. Machine washable at 30°C.
Goes with trousers 160303, 160304 and 160305.

160300 - S

160301 - M

160302 - L

PANTALON ESTHÉTIQUE BLANC

76 % polyester, 21 % viscose, 3 % polyurethane. Lavable en machine à 30°C.
Assorti aux blouses 160300, 160301 et 160302.

WHITE BEAUTICIAN'S TROUSERS

76 % polyester, 21 % viscose, 3 % polyurethane. Machine washable at 30°C.
Goes with jackets 160300, 160301 and 160302.

160303 - S

160304 - M

160305 - L



TABLIER ESTHÉTIQUE NOIR

100% polyester. Lavable en machine à 30°C. Taille unique.

BLACK BEAUTICIAN'S APRON

100% polyester. Machine washable at 30°C. One size fits all.

160081

TABLIER NOIR PEGGY SAGE COLORAMA

100% polyester. Lavable en machine à 30°C. Taille unique.

COLORAMA BLACK BEAUTICIAN'S APRON

100% polyester. Machine washable at 30°C. One size fits all.

160083



MULES EN ÉPONGE

100% polyester. Taille unique. Blanches. Lavables en machine à 30°C.

TERRY TOWEL MULES

100% polyester. One size fits all, white. Machine-washable at 30 °C.

160125 - la paire / the pair



160125

MULES EN ÉPONGE

80% coton / 20% polyester. Taille unique. Lavable en machine à 30°C.

TERRY TOWEL MULES

80% cotton / 20% polyester. One size. Machine washable at 30°C.

160022 - la paire / the pair



160022



PANTOUFLES JETABLES, TAILLE UNIQUE DISPOSABLE SLIPPERS, ONE SIZE FITS ALL

160100 - rose / pink

160111 - blanc / white

SOUTIEN-GORGE DISPOSABLE BRA

Taille unique - noir - non tissé
One size fits all, black, nonwoven.

170068 -x6



170060



170061



170062



170063



170064

SLIPS JETABLES, TAILLE UNIQUE, NON TISSÉS DISPOSABLE BRIEFS, ONE SIZE FITS ALL, NONWOVEN

170060

sachet de 50, non tissé
Bag of 50
Nonwoven

170061

12 slips femme
12 women's briefs

170062

6 slips femme
6 women's briefs

170063

6 slips homme
6 men's briefs

170064

6 boxers jetables homme
6 men's boxer shorts



100 CHARLOTES NON TISSÉES
100 NONWOVEN MOB CAPS
170051

50 CHARLOTTES PLASTIQUE

Imperméables et transparentes.

50 PLASTIC MOB CAPS

Waterproof and transparent.

170050



LOT DE 50 BANDEAUX JETABLES
PACK OF 50 DISPOSABLE HAIRBANDS
170052

BONNET TURBAN BLANC

80% coton / 20% polyester. Lavable en machine à 30°C.

WHITE TURBAN

80% cotton / 20% polyester. Machine washable at 30°C.

160013



BANDEAU SIMPLE BLANC

100% coton. Lavable en machine à 30°C. Taille unique.

WHITE SINGLE HAIRBAND

100% cotton. Machine washable at 30°C. One size fits all.

160330



| MOBILIER D'INSTITUT / SALON FURNITURE

TABOURET MANUCURE PRO

Grâce à son design ergonomique, le tabouret manucure pro offre le plus grand confort au professionnel de la manucurie. Doté d'un petit dossier arrondi, aisément ajustable, léger et peu encombrant, non salissant, il représente votre parfait allié pour un usage prolongé dans le temps.

PRO MANICURE STOOL

Thanks to its ergonomic design the pro manicure stool provides maximum comfort for manicure professionals. Fitted with a small rounded back support, easily adjustable, light, compact and soil-resistant, it is the perfect stool for prolonged use over the long term.

155003 - 5,9 kg

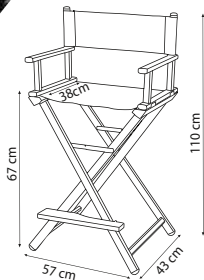
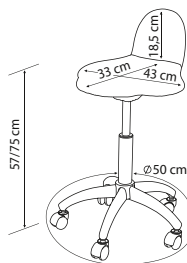

FAUTEUIL MAKE-UP

Structure en aluminium sablé et anodisé, structure soudée. Assise en polyester avec revêtement tissé. Dossier tissé.

MAKE-UP ARMCHAIR

Sandblasted and anodized aluminium structure, welded structure. Polyester seat with woven covering. Woven seat back.

155022 - 4,4 kg

TABLE MANUCURE PLIANTE

Livrée avec housse de transport.

FOLDING MANICURE TABLE

Supplied with carry bag.

155115 - 11 kg

Dimensions table ouverte / dimensions of table when extended: 94 x 30-35 x 74 cm.

Dimensions table pliée / dimensions of table when folded: 94 x 30-35 x 20 cm.





LAMPE LED DESIGN POUR TABLE MANUCURE

Puissante et économe en énergie grâce à ses 27 lampes à LED de haute qualité. Durée de vie jusqu'à 35 000 heures. 3 types d'éclairages différents : lumière froide, chaude ou naturelle - intensité variable. Affichage digital : date, heure et température. Contrôle tactile : marche/arrêt, type et intensité d'éclairage. Pliable, orientable et articulée. Garantie sur le matériel électrique : 2 ans.

STYLISH 10 W LED MANICURE TABLE LAMP

Powerful and energy-efficient thanks to its 27 high-quality LED lamps. Lifespan up to 35,000 hours. An innovative design and elegant styling for lighting your workspace. 3 different types of lighting: cold, warm and natural light - variable intensity. Digital display: date, hour and temperature. Touch control: on/off, type of lighting and lighting intensity. Bendable, adjustable and articulated. Electrical equipment warranty: 2 years.

155207 - 10 W - 43 x 35 x 20 cm - 1,5 kg

LAMPE LOUPE DE TABLE AVEC CLIP ET PIED AMOVIBLE

Ultra fonctionnelle et modulable, la lampe loupe s'adapte parfaitement à votre espace de travail grâce à son clip et à son pied amovible. Loupe 3 dioptries. Garantie sur le matériel électrique : 2 ans.

TABLE-TOP ILLUMINATED MAGNIFIER WITH CLIP AND DETACHABLE STAND

With its clip and detachable stand, this extremely functional and modular Peggy Sage illuminated magnifier fits into your work space seamlessly. 3-dioptre magnifier. Electrical equipment warranty: 2 years.

155220 - 30 LED - 6 W / 20 V CC - 38 x 16 x 32 cm



LAMPE LOUPE DE TABLE

La lampe loupe de table articulée et facilement transportable, est le compagnon idéal à la réalisation des tâches les plus minutieuses. Loupe 3 dioptries. Garantie sur le matériel électrique : 2 ans.

TABLE-TOP ILLUMINATED MAGNIFIER

This articulated and portable Peggy Sage illuminated magnifier is the perfect companion for even the most detailed work. 3-dioptre magnifier. Electrical equipment warranty: 2 years.

155221 - 36 LED - 6 W / 220-240 V - 24 x 18 x 36 cm

LAMPE-LOUPE

Lampe loupe de 3 dioptries avec éclairage économique par LED. Articulée, orientable, elle est compatible avec la table manucure Peggy Sage 155115. Peut se fixer sur un plan de travail d'une épaisseur maximum de 63 mm. Hauteur de travail maximum 75 cm. Garantie sur le matériel électrique : 2 ans.

ILLUMINATED MAGNIFIER

3-dioptre illuminated magnifier with economical LED light. Perfect for lighting high-precision work. This articulated, adjustable magnifier is compatible with Peggy Sage manicure table 155115. Can be fixed to a work surface of a maximum thickness of 63 mm. Maximum working height 75 cm. White lacquer finish. Electrical equipment warranty: 2 years.

155209 - H 72 cm
pied pour lampe - livré démonté
stand / self-assembly

155208 - 6 W



155209

155208

LIT D'ESTHÉTIQUE PLIANT LÉGER

Livré avec housse trolley. Dossier inclinable env. 50°.
Housse avec roulettes et poignée.

LIGHTWEIGHT FOLDING SALON COUCH

Supplied with trolley cover. Back rest reclines approx. 50°.
Carry bag with wheels and handle.

155055 - 13 kg



155055

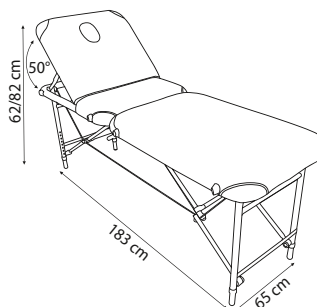

155253

ASPIRATEUR DE TABLE PORTABLE

Aspirateur de table ergonomique et mobile pour la manucurie et la prothèse ongulaire. S'adapte sur tous les types de table. Assainit l'air en aspirant les poussières issues du limage tout en servant de coussin repose-main à la cliente. Livré avec 10 sacs. Similicuir. Garantie sur le matériel électrique : 1 an.

PORTABLE TABLE VACUUM CLEANER

Ergonomic and mobile table vacuum cleaner for manicures and artificial nail construction. Suitable for all types of tables. Cleans the air by removing filing dust, while also serving as a client hand rest cushion. Supplied with 10 bags. Leatherette. Electrical equipment warranty: 2 years.

155253 - 32 x 29,5 x 13 cm
2,5 kg - 220-240V 50 Hz - 19 W

155254
10 sacs aspirateurs
10 vacuum cleaner bags



155254

| BAGAGERIE / LUGGAGE



VANITY AVEC COMPARTIMENTS AMOVIBLES

Spacieux et astucieux, délicieusement tendance, le vanity manucure Peggy Sage va devenir le compagnon indispensable à tous vos déplacements cet été. Ses compartiments vous permettront de transporter vos vernis à ongles et semi-permanents en toute sécurité, à l'abri de la chaleur.

VANITY CASE WITH REMOVABLE DIVIDERS

Spacious, well designed and wonderfully trendy, the Peggy Sage manicure vanity case will be your must-have go-anywhere companion this summer. Carry around your standard and semi-permanent nail lacquers in the clever compartments, keeping them cool and safely tucked away.

200010 - 21 x 14,5 x 13 cm - livrée vide / supplied empty



VALISE PROFESSIONNELLE

Petite valise professionnelle à compartiments multiples pour un rangement optimal du matériel. 4 compartiments escamotables de 25 x 7,5 x 3 cm.
1 compartiment de 26 x 19 x 10 cm

PROFESSIONAL VANITY CASE

Professional small vanity case with multiple compartments for optimum equipment storage. 4 fold-out compartments 25 x 7.5 x 3 cm.
1 compartment 26 x 19 x 10 cm.

200163 - 28 x 20 x 21 cm - 1,7 kg - livrée vide / supplied empty



SAC MAKE-UP

Il est composé de 2 grands compartiments dans lesquels se trouvent 2 grandes et 3 petites troussees transparentes, permettant de retrouver vos affaires en un coup d'œil.

MAKE-UP BAG

The perfect bag for carrying your make-up around with you. It features 2 large compartments containing 2 large and 3 small transparent pockets that make it easy to find what you are looking for in a flash.

200182 - 33 x 22 x 26 cm - noir - livrée vide / supplied empty

MALLETTE PROFESSIONNELLE

Mallette professionnelle à compartiments multiples pour un rangement optimal du petit matériel. 4 compartiments escamotables en plastique de 32 x 9 x 3,5 cm.
1 compartiment de 32 x 20 x 14 cm avec habillage tissu noir.

PROFESSIONAL VANITY CASE

Professional vanity case with a large number of compartments for optimum storage of small equipment. 4 plastic fold-out compartments 32 x 9 x 3.5 cm.
1 compartment 32 x 20 x 14 cm lined with black fabric.

200164 - 37 x 22,5 x 24 cm - 2,7 kg - livrée vide / supplied empty



VALISE PROFESSIONNELLE

Valise professionnelle à compartiments multiples pour un rangement optimal du matériel.

PROFESSIONAL CASE

Professional vanity case with multiple compartments for optimum equipment storage.

200207 - 37 x 27 x 25 cm - 2,6 kg - livrée vide / supplied empty



VALISE PROFESSIONNELLE TROLLEY

Hauteur des compartiments en partant du bas : 15, 30, 15 et 6 cm.
Serrures à clefs, 2 roulettes.

PROFESSIONAL TROLLEY CASE

Height of compartments starting from the bottom: 15, 30, 15 and 6 cm.
Keys with locks, 2 wheels.

200104 - 43 x 23 x 72 cm - 7,3 kg - grise / grey - livrée vide / supplied empty

200125 - 43 x 23 x 72 cm - 7,3 kg - noire / black - livrée vide / supplied empty





TROLLEY 2 EN 1

Valise à roulettes 360°, poignée extensible et serrures à clefs. Les deux compartiments sont facilement détachables et peuvent être utilisés seuls. La plus petite valise est équipée d'un intérieur spacieux et de 4 compartiments escamotables. Fourni avec miroir sur pied et bandoulière. La plus grande valise dispose d'élastiques pour un meilleur maintien des produits. Elle contient également un panier de rangement adaptable grâce à ses cloisons ajustables.

2-IN-1 TROLLEY CASE

Trolley case mounted on 360° castors with pull-out handle and key-operated locks. The two sections can be easily detached and used independently. The smaller case is 13 cm high and features a spacious interior with 4 fold-out compartments measuring 20 x 16 x 4.5 cm. It comes with a mirror on a stand and a shoulder strap. The larger case is 43 cm high and features elastic strips to hold your products in place. It also contains a modular storage section with adjustable partitions.

200127 - 37 x 25 x 71 cm - 8,9 kg - noir / black - livré vide / Supplied empty

TABLE MAQUILLAGE PORTABLE

Véritable studio mobile grâce à son système de trolley robuste et ses 4 roulettes intégrées larges et solides, cette table de maquillage est facile à transporter avec ses 3 poignées de transport. Elle dispose de 4 pieds rangés dans la valise, faciles à monter et réglables de 55 à 92 cm de hauteur pour un confort de travail optimal.

Elle est également équipée d'un grand miroir (35 x 40,5 cm) entouré de 6 ampoules au culot standard. Elle possède un branchement électrique supplémentaire en façade pour les petits appareils (sèche-cheveux, lisseur...).

L'intérieur est composé d'un grand compartiment central (34 x 32 cm) avec un support d'accessoires amovible, ainsi que 4 casiers coulissants. Un cordon électrique de 2,30 m est également fourni. Garantie sur le matériel électrique : 2 ans.

PORTABLE MAKE-UP TABLE

Nothing less than a mobile studio with its robust trolley case design and 4 wide hardwearing integrated castors, this make-up table is easy to transport thanks to its 3 carry handles. With 4 easy-to-extend legs adjustable to any length between 55 and 92 cm for optimum working comfort, which simply store away inside the case when not required. It also boasts a large mirror (35 x 40.5 cm) flanked by 6 standard-cap light bulbs. It features an additional electrical connection point on the front for small devices such as hairdryers and straighteners. The interior contains a large main compartment (34 x 32 cm) with a removable accessory tray plus 4 pull-out tray compartments.

A 2.3m power cord is also included. Electrical equipment warranty: 2 years.

155144 - 45 x 25 x 58 cm - 13,18 kg - livrée vide / supplied empty



| MATÉRIEL MARKETING MARKETING EQUIPMENT

PANIER

Cotés habillés par un filet synthétique amovible pour un nettoyage facile.

BASKET

Sides lined with a removable synthetic mesh for easy cleaning.

200036 - 35 x 27 x 18 cm - 510 g



200303



200304

SACS REVENTE PLASTIQUE

PLASTIC RETAIL BAG

200303 - x50 - 35,5 x 25 cm - PM

200304 - x50 - 48 x 40,5 cm - GM

SAC CABAS NON TISSÉ

Impression 2 faces. 2 poignées en nylon.

NONWOVEN SHOPPING BAG

Printed on both sides. 2 nylon handles.

140 g/m²

200087

47,2 x 36,2 x 20 cm

Petite poche intérieure avec fermeture pression

Small internal pocket with press studs.

200088

24 x 31 x 21 cm

200089

38 x 30 x 11 cm



200087

200089

200088



620151



620152

SAC EN KRAFT BROWN PAPER BAG

620151 - 18/8 x 22 cm

620152 - 22/10 x 28 cm

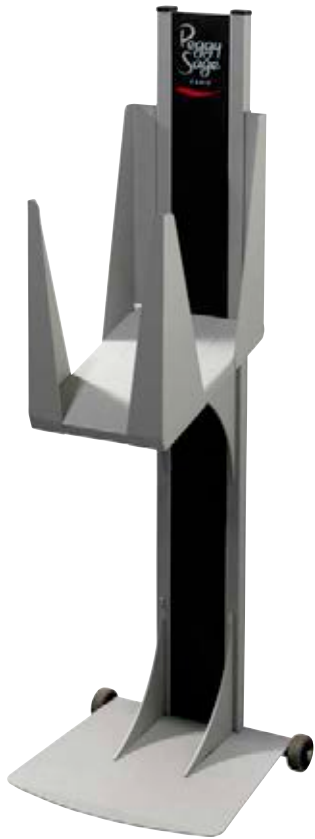

PORTE CATALOGUES

Présentoir équipé de 2 roulettes et d'une poignée pour un déplacement facile.
Plateau de présentation fixe et incliné.

CATALOGUE STAND

Display stand mounted on 2 wheels with handle for easy repositioning.
Fixed, inclined presentation surface.

155370 - 40 x 35 x 118 cm

PLANNING

000500 - 30x22 cm



CARNET DE CAISSE

Disponible uniquement en français.

BILL PAD

Available in French only.

000600

VITROPHANIE

WINDOW ADVERTISING STICKER

156200 - 21x29,7 cm



NEW

KAKEMONO

Impression 2 faces.
2 sided printing.

156515 - 58x136 cm

156516 - 58x136 cm



156515



156516

NEW

KAKEMONO

Impression 2 faces.
2 sided printing.

156513 - 58x136 cm

156514 - 58x136 cm

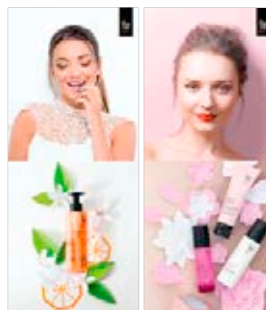

156513



156514



156517



156518

KAKEMONO

Impression 2 faces.
2 sided printing.

156517 - 58 x 136 cm

156518 - 58 x 136 cm

NEW

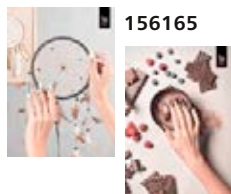

156165

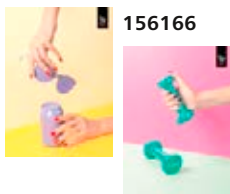

156166

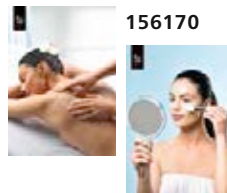

156170



156171

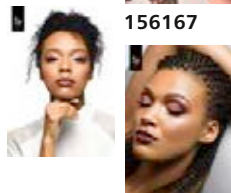

156167



156168

POSTER

156165 - 50x70 cm

156166 - 50x70 cm

156167 - 50x70 cm

156168 - 50x70 cm

156170 - 50x70 cm

156171 - 50x70 cm

NEW

| PRÉSENTOIRS / DISPLAYS



PRÉSENTOIR VERNITHÈQUE VIDE
EMPTY NAIL LACQUER DISPLAY UNIT

000640 - 21 x 16 x 30 cm

PRÉSENTOIR CRÈMES MAINS & CORPS

Contient 6 crèmes de chaque référence + 1 testeur offert :

- 120360 - agrumes / thé vert
- 120361 - grenade / papaye
- 120362 - mangue / passion
- 120364 - monoi / tiaré
- 120372 - fleur de cerisier
- 120378 - noix de coco

DISPLAY FRAGRANT HAND & BODY CREAMS

Contains 6 of each cream item number + 1 free tester:

- 120360 - citrus / green tea
- 120361 - pomegranate / papaya
- 120362 - mango / passion fruit
- 120364 - monoi / tiare
- 120372 - cherry blossom
- 120378 - coconut

120375 - 18 x 24 x 24 cm



NEW

PRÉSENTOIR VIDE LES MINIS BY PEGGY SAGE
EMPTY DISPLAY LES MINIS BY PEGGY SAGE

105991 - 40 x 14 x 41,5 cm



NEW

PROFESSIONAL COLORS
PRÉSENTOIR VERNIS À ONGLES 11 ML VIDE
EMPTY 11 ML NAIL LACQUER DISPLAY UNIT
000631 - 41 x 20 x 55 cm

PRÉSENTOIR I-LAK VIDE
EMPTY I-LAK DISPLAY
190191 - 45,5 x 17,5 x 37 cm



NEW



NEW

PRÉSENTOIR ÉVASION PARFUMÉE

Contient 144 pièces + 24 testeurs offerts :

- 24 baumes lèvres + 6 testeurs
- 24 crèmes mains et corps 30 ml + 6 testeurs
- 24 crèmes mains et corps 125 ml
- 24 gels moussants nettoyants mains 250 ml
- 24 gommages corps 100 ml + 6 testeurs
- 24 gels douche 100 ml + 6 testeurs

DISPLAY ÉVASION PARFUMÉE

Contains 144 of each + 24 free tester:

- 24 lip balms + 6 tester
- 24 hand & body creams 30 ml + 6 tester
- 24 hand & body creams 125 ml
- 24 foaming cleansing hand gels 250 ml
- 24 body scrubs 100 ml + 6 tester
- 24 shower gels 100 ml + 6 tester

120352 - 41 x 28 x 154 cm

| PRÉSENTOIRS MODULABLES MODULAR DISPLAYS



000290

PRÉSENTOIR MODULABLE MODULAR DISPLAY

Dim. : 460-380-560 mm - livré vide / supplied empty

000290

PRÉSENTOIR MODULABLE DE COMPTOIR MODULAR COUNTER-TOP DISPLAY

Dim. : 460-380-560 mm - livré vide / supplied empty

000291



000291



612010



612011



612013



612014

612010 - PM 5 vernis x 6 pcs. / S module, 5 x 6 nail lacquers.
Dim. 150 mm - livré vide / supplied empty

612011 - GM 10 vernis x 6 pcs / L module, 10 x 6 nail lacquers.
Dim. 300 mm - livré vide / supplied empty

612013 - PM 5 rouges à lèvres x 6 pcs + 1 testeur
S module, 5 x 6 lipsticks + 1 tester
Dim. 150 mm - livré vide / supplied empty

612014 - GM 10 rouges à lèvres x 6 pcs + 1 testeur
L module, 10 x 6 lipsticks + 1 tester
Dim. 300 mm - livré vide / supplied empty



612015



612016



612017

612015 - PM 12 crayons / mascaras x 6 pcs + 1 testeur
S module, 12 x 6 pencils / mascaras + 1 tester
Dim. 150 mm - livré vide / supplied empty

612016 - PM 4 ombres à paupières / blush x 3 pcs + 1 testeur
S module, 4 x 3 eye shadows / blushes + 1 tester
Dim. 150 mm - livré vide / supplied empty

612017 - GM 10 ombres à paupières / blush x 3 pcs + 1 testeur
L module, 10 x 3 eye shadows / blushes + 1 tester
Dim. 300 mm - livré vide / supplied empty

612018 - GM 6 poudres x 6 pcs + 1 testeur
L module, 6 x 6 powders + 1 tester
Dim. 300 mm - livré vide / supplied empty



612018



612020

612020 - XXL étagère plane / XXL module flat shelf unit
Dim. 600 mm - livré vide / supplied empty



612021

612021 - I-LAK. Dim. 300 mm - livré vide / supplied empty



LA FORMATION, AU CŒUR DE NOS PRIORITÉS !

Peggy Sage vous garantit une formation complète pour vous permettre d'approfondir vos connaissances pratiques et théoriques sur l'ensemble de nos produits.

En tant qu'ambassadeurs de notre marque, nous sommes soucieux de vous tenir informés sur les techniques d'utilisation et de vente de nos produits.

Pour vous apporter les explications nécessaires à la bonne compréhension de nos produits, nous mettons nos compétences commerciales et notre savoir-faire technique à votre service. En étant accompagnés, vous serez ainsi en mesure de conseiller les bons produits et d'assurer ainsi un véritable rôle de proximité auprès de votre clientèle.

TRAINING – ONE OF OUR KEY PRIORITIES!

Peggy Sage guarantees you a complete range of training to develop your practical and theoretical knowledge of all our products.

We are committed to keeping you, as ambassadors of our brand, informed about the usage and sales techniques of our products.

To ensure you have all the information you need to understand our products properly, we put our sales expertise and technical know-how to work for you. With our support, you will be able to advise your clients on the right products for them, ensuring a close working relationship.

“

EXPERTISE • CRÉATIVITÉ • PROXIMITÉ
AUDACE & DYNAMISME

”

“

EXPERTISE • CREATIVITY • INTIMACY
BOLDNESS & ENERGY

”



Prothèse onguilaire
Manucure / Pédicure
Artificial nail
construction
Manicures / pedicures

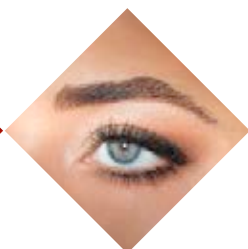

Extension de cils
Eyelash extensions



Make-up



Epilation
Depilation



Soins visage
et corps
Facial and
body care

Depuis plus de 90 ans, Peggy Sage met tout son savoir-faire et son service à la disposition des professionnels de l'esthétique.

Élargissez ou renforcez vos compétences grâce à l'accompagnement que vous propose Peggy Sage. Initiez-vous aux méthodes classiques ou perfectionnez vos techniques.

Plus d'informations sur peggysage.com/formations

For more than 90 years, Peggy Sage has been offering its extensive expertise and services to beauty industry professionals.

Broaden or consolidate your skills through the support on offer from Peggy Sage. Learn the basics of the standard methods or perfect your techniques.

More information at peggysage.com

A	
Accélérateur de séchage.....	85
Accessoire pédicure.....	288-291
Accessoire professionnel.....	366-397
Accessoires électriques ongles.....	136-139
Accessoires épilation.....	261-267
Accessoires et petit matériel ongles.....	132-135
Accessoires extensions de cils.....	245-250
Accessoires maquillage.....	222-241
Accessoires ongles.....	120-163
Acrylique (Sculpting +).....	42-45, 48-51
Ampoule.....	316-317, 328
Anti-cernes.....	178
Anti-jaunisseur pour ongles.....	83
Anti-stries pour ongles.....	83
Appareil chauffe-paraffine.....	273
Autobronzant.....	361

B	
Bagagerie.....	388-390
Base pour ongles.....	11, 12, 19, 53, 61, 69, 75
Base de teint.....	167
Base peel-off.....	12, 61, 83
BB Crème.....	169
BB nail.....	61, 79
Blush.....	184

C	
Capsules professionnelles.....	40, 111-116, 288
CC Crème.....	169
Chauffe-cire à épiler.....	266-267
Cils de soie professionnels.....	243-244
Cire chaude.....	256-257
Cire froide.....	261
Cire tiède.....	258-260
Ciseaux.....	161, 239
Cleaner triple action pour ongles.....	87
Cleanse spray hygiénique.....	86, 272
Colle à ongles.....	84, 94, 99, 115
Colle extension de cils.....	245
Complexes aux huiles essentielles.....	341-343
Correcteurs de teint.....	176-177
Coutellerie.....	159-161
Crayon à sourcils.....	187, 188, 189
Crayons lèvres.....	213-214
Crayons yeux.....	198-200
Crème de modelage.....	340
Crème de soin pour les mains.....	271, 273, 276, 354-355
Crème décolorante.....	350
Crèmes de soin visage.....	320-323, 327, 329, 332, 364

D	
Démaquillant.....	293-296, 326
Déodorant homme.....	364
Dépose I-LAK, 1-LAK et résine.....	118-119
Détox.....	326-327
Diluant pour vernis à ongles.....	85
DIP IN +.....	46-47
Dissolvant.....	88-89
Durcisseur pour ongles.....	82

E	
Eau émoulliente pour ongle.....	80
Embellissement du regard.....	242-253
Embouts de pompe.....	140-145
Enlumineur / Illuminateur / Highlighter.....	183
Entraînement / présentation.....	162-163
Entraînement extension de cils.....	250
Enveloppement corps.....	344-345
Épilation.....	254-267
Éponges.....	234-236, 379

Évasion parfumée.....	277, 324, 351-355
Extensions de cils / sourcils.....	243-250
Eyeliners.....	202-203

F	
Fards à joues.....	184
Faux cils.....	208-211
Faux ongles.....	116-117
Fixateur de maquillage.....	168
Fixateur de sourcils.....	187
Fixateur rouge à lèvres.....	221
Fleur d'orient.....	358-359
Fond de teint.....	170-174
Foot spa.....	286-287
Formes.....	109-110
French manucure.....	44, 58-59, 76
French manucure Gel UV.....	21, 26, 29

G	
Gants.....	136, 234, 272, 337, 358, 361, 371, 372, 379
Gel calcium pour ongles.....	82
Gel de rasage.....	364
Gel douche.....	335, 351, 363
Gel hydratant pour ionophorèse.....	350
Gel minceur.....	348
Gel moussant nettoyant mains.....	277
Gel pro 3.1.....	28-29
Gel raffermissant.....	348
Gel sculpt.....	38-41
Gel UV de construction.....	20, 24, 25, 29
Gel UV de finition.....	26, 29
Gel UV&LED de base.....	19, 23, 36
Gel UV&LED de construction.....	20, 24, 27, 29
Gel UV&LED de couleur (Technigel).....	31-37
Gel UV&LED de finition.....	21, 26-27
Gloss à lèvres.....	221
Gommage corps.....	336-337, 352, 356, 358
Gommage mains.....	274, 278
Gommage pieds.....	281, 287
Gommage visage.....	298-300, 331, 363

H	
Hand spa.....	278-279
Huile "soin intensif" énergisante pour ongles.....	81
Huile cuticule.....	81
Huile de modelage.....	338, 357, 359
Huile fortifiante pour ongles.....	80
Huile solaire.....	360

IK	
I-GEL 2.0.....	18-21
Idéalift.....	330-332
Instrument dégradé et baby boomer.....	130
Kit 4 cartouches de cire tiède à épiler.....	260
Kit dip in +.....	47
Kit extensions de cils.....	250
Kit French manucure.....	59
Kit gel sculpt.....	41
Kit manucure tiède.....	271
Kit pansements adhésifs.....	84
Kit paraffine.....	273
Kit résine.....	45
Kit stamping.....	102
Kit Technigel.....	27
Kit teinture de cils.....	252
Kit voyage.....	372

L	
Lagoon island.....	356-357
Lait hydratant pour le corps.....	346, 357, 359
Lampe LED.....	137

Lampe UV.....	136
Limes à ongles.....	146-158
Linge.....	377, 379, 380-384
Lingettes.....	261, 293, 298
Liquide de façonnage.....	45
Lotion fraîcheur jambes légères.....	349

M	
Manucurie tiède.....	271
Maquillage.....	164-253
Maquillage lèvres.....	212-221
Maquillage yeux.....	190-211
Mascara.....	204, 206, 245
Masque mains.....	275, 276, 279
Masque visage.....	302-312, 326, 327, 331
Masques pieds.....	285, 287
Matériel d'institut.....	368-384
Matériel marketing.....	391-393
Mini vernis à ongles.....	60-73
Miroirs.....	241
Mobilier d'institut.....	385-387
Modelage.....	338, 340, 356, 357, 359

NO	
Nail art.....	90-106
Néon de rechange.....	136
Nettoyant pinceaux résine.....	131
Nettoyant visage.....	296-298
Ombre à paupières.....	191-197
Ongles.....	4-163
Onglier verge.....	163
Outil à marbrer.....	129-130

P	
Paillettes pour ongles.....	94-98
Palette ombre à paupières.....	193, 194, 196
Peinture pour ongles.....	100-101
Pince à ongles.....	159, 291
Pince nail art.....	92
Pinceau 1-stroke.....	124
Pinceau gel.....	125-127
Pinceau nail art.....	121-124
Pinceau résine.....	128-129
Pinceau visage et corps.....	378
Pinceaux maquillage.....	223-231
Pinceaux ongles.....	121-129
Pinces à épiler.....	239, 240
Ponceuses.....	138-139
Poudre.....	179-182
Poudre bronzante.....	181
Poudre compacte.....	179
Poudre de façonnage.....	44, 49-51
Poudre de teint.....	182
Poudre libre.....	182
Poudre lumière irisée.....	181
Poudre lumière visage et corps.....	179
Poudre mosaïc.....	181
Présentoir.....	394-397
Primer ongle.....	11, 19, 23, 43

R	
Recourbe cils.....	238
Réhaussement de cils.....	251-252
Rouges à lèvres.....	216-221

S	
SCULPTING+ couleurs.....	48-51
Sèche-verniss.....	372
Sérum.....	313-316, 327, 329, 331
Set pinceaux make-up.....	224, 225
Set manucure.....	161

Set pinceaux ongle	122-123
Soin	268-365
Soin contour des yeux	318, 329, 332
Soin des lèvres	324-325
Soin des mains	270-279
Soin des ongles	78-89
Soin des pieds	273, 280-291
Soin du corps	334-361
Soin du visage	292-333
Soin paraffine	272-273
Soin pour homme	362-365
Soins spécifiques corps	348-350
Sourcils	186-189
Spatule	264, 375, 378
Splendilift	328-329
Spray séchant pour vernis à ongles	85
Stamping	102-103
Stickers	104-106
Stop ongles rongés	83
Strass pour ongles	91-93
Stylo nail art & French manucure	58
Sun activ	360-361
Super dégraissant pour ongles	86

T	
Taille-crayons	239
Talc	261, 347
Technigel - Cat eye	37
Technigel - Paint	37
Technigel - Plastigel	36
Technigel - Waterway	36
Technigel color IT	31-34
Teinture de cils et sourcils	252-253
Tip soften	114
Tips off	119
Top coat	9, 53, 54, 55, 61, 69, 75, 98
Top finish	17, 21
Transfer foils	99

VW	
Vernis à ongle Forever lak	74-77
Vernis à ongles 1-LAK	6-9
Vernis à ongles COLOR IS LIFE	68-69
Vernis à ongles I-LAK	11-17
Vernis à ongles IT-COLOR	62-63
Vernis à ongles Kids	72-73
Vernis à ongles PERFECT LASTING	66-67
Vernis à ongles QUICK DRY	64-65
Vernis à ongles Timeless style	70-71
Vernis semi-permanent	6-9, 11-17

A	
Acrylic (Sculpting +)	42-45, 48-51
Acrylic brush cleaner	131
Acrylic resin kit	45
Adhesive manucure wrap kit	84
Ampoules	316-317, 328
Antibite clear	83
Artificial nails	116-117

B	
BB cream	169
BB Nails	61, 79
Blank nail lacquer palette	163
Bleaching cream	350
Blush	184
Blushes	184
Body care	334-361
Body scrubs	336-337, 352, 356, 358
Body wraps	344-345
Brow-tinting kit	252
Builder UV gel	20, 24, 25, 29

C	
Calcium gel for nails	82
Care cream for hands	271, 273, 276, 354-355
CC cream	169
Cleanse hygienic spray	86, 272
Cleansers	293-296, 326
Cold wax	261
COLOR IS LIFE nail lacquers	68-69
Colour gradient and baby boomer tool	130
Colour reviver for nails	83
Concealers	176-177
Cooling lotion for tired legs	349
Cuticle oil	81
Cuticle remover for nails	80
Cutlery	159-161

D	
Dark circle concealer	178
Depilation	254-267
Depilation accessories	261-267
Depilatory wax heaters	266-267
Detox	326-327
DIP IN +	46-47
Dip In + kit	47
Displays	394-397
Drying accelerator	85
Drying spray for nail lacquer	85

E	
Electric nail accessories	136-139
Electric nail file bits	140-145
Electric nail files	138-139
Electric nail lacquer dryer	372
Energizing intensive care oil for nails	81
Essential oils complexes	341-343
Eye contour treatment	318, 329, 332
Eye make-up	190-211
Eye shadow palettes	193, 194, 196
Eye shadows	191-197
Eyebrow fixer	187
Eyebrow pencils	187, 188, 189
Eyebrows	186-189
Eyelash / eyebrow extensions	243-250
Eyelash curler	238
Eyelash extension accessories	245-250
Eyelash extension glue	245
Eyelash extension kit	250
Eyelash extension training	250
Eyeliner pencils	198-200
Eyeliners	202-203

F	
Face and body brush	378
Face scrubs	298-300, 331, 363
Facial care	292-333
Facial care creams	320-323, 327, 329, 332, 364
Facial cleansing	296-298
Facial masks	302-312, 326, 327, 331
False eyelashes	208-211
Finishing UV gel	26, 29
Firming gel	348
Fleur d'Orient	358-359
Foaming hand-cleansing gel	277
Foot care	273, 280-291
Foot masks	285, 287
Foot scrubs	281, 287
Foot spas	286-287
Forever Lak nail lacquers	74-77
Forms	109-110
Fortifying oil for nails	80
Foundations	170-174
Fragrant Escape	277, 324, 351-355

French manucure	44, 58-59, 76
French manucure kit	59
French manucure UV gel	21, 26, 29

G	
Gaze enhancement	242-253
Gel brushes	125-127
Gel Sculpt	38-41
Gel Sculpt kit	41
Gloves	136, 234, 272, 337, 358, 361, 371, 372, 379

H	
Hand care	270-279
Hand masks	275, 276, 279
Hand scrubs	274, 278
Hand spa	278-279
Hot wax	256-257

IJK	
I-GEL 2.0	18-21
I-LAK nail lacquers	11-17
I-LAK, 1-LAK and resin removal	118-119
Idéalift	330-332
Illuminating face and body powder	179
Illuminator / Highlighter	183
IT-COLOR nail lacquers	62-63
Kids nail lacquers	72-73
Kit of 4 cartridges of warm depilatory wax	260

L	
Lagoon Island	356-357
Lash and brow tinting	252-253
Lash lift	251-252
LED lamp	137
Linen	377, 379, 380-384
Lip care	324-325
Lip gloss	221
Lip liners	213-214
Lip make-up	212-221
Lipstick fixative	221
Lipsticks	216-221
Loose powder	182
Luggage	388-390

M	
Make-up	164-253
Make-up accessories	222-241
Make-up base	167
Make-up brush set	224, 225
Make-up brushes	223-231
Make-up fixer	168
Manicure set	161
Marbling tool	129-130
Marketing equipment	391-393
Mascara	204, 206, 245
Men's deodorant	364
Men's skincare	362-365
Mini nail lacquers	60-73
Mirrors	241
Moisturizing body milk	346, 357, 359
Moisturizing gel for iontophoresis	350
Mosaic powder	181

N	
Nail accessories	120-163
Nail accessories and small equipment	132-135
Nail art	90-106
Nail art & French manucure pen	58
Nail art brushes	121-124
Nail art tweezers	92

Nail base.....	11, 12, 19, 53, 61, 69, 75
Nail brush sets.....	122-123
Nail brushes.....	121-129
Nail care.....	78-89
Nail clippers.....	159, 291
Nail files.....	146-158
Nail glitters.....	94-98
Nail glue.....	84, 94, 99, 115
Nail hardener.....	82
Nail lacquer remover.....	88-89
Nail lacquer thinner.....	85
Nail paints.....	100-101
Nail primer.....	11, 19, 23, 43
Nail ridge filler.....	83
Nail stamping.....	102-103
Nail-stamping kit.....	102
Nails.....	4-163

P

Paraffin wax heater.....	273
Paraffin wax kit.....	273
Paraffin wax treatment.....	272-273
Pedicure accessories.....	288-291
Peel-off base.....	12, 61, 83
Pencil sharpener.....	239
PERFECT LASTING nail lacquers.....	66-67
Powder blush.....	182
Powders.....	179-182
Pressed powder.....	179
Pro 3.1 gel.....	28-29
Professional accessories.....	366-397
Professional silk lashes.....	243-244
Professional tips.....	40, 111-116, 288

RS

Resin brushes.....	128-129
Rhinestones for nails.....	91-93
Salon equipment.....	368-384
Salon furniture.....	385-387
Scissors.....	161, 239
Sculpting.....	338, 340, 356, 357, 359
Sculpting cream.....	340
Sculpting liquid.....	45
Sculpting oils.....	338, 357, 359
Sculpting powders.....	44, 49-51
SCULPTING+ colours.....	48-51
Self-tanning.....	361
Semi-permanent nail lacquers.....	6-9, 11-17
Serums.....	313-316, 327, 329, 331
Shaving gel.....	364
Shimmering illuminating powder.....	181
Shower gels.....	335, 351, 363
Skincare.....	268-365
Slimming gel.....	348
Solaire oil.....	360
Spare neon bulb.....	136
Spatula.....	264, 375, 378
Special body treatments.....	348-350
Splendilift.....	328-329
Sponges.....	234-236, 379
Stickers.....	104-106
Sun Activ'.....	360-361
Super oil remover for nails.....	86

T

Talcum powder.....	261, 347
Tanning powder.....	181
Technigel - Cat Eye.....	37
Technigel - Paint.....	37
Technigel - Plastigel.....	36
Technigel - Waterway.....	36
Technigel Color It.....	31-34
Technigel kit.....	27

Timeless Style nail lacquers.....	70-71
Tip soften.....	114
Tips off.....	119
Top coat.....	9, 53, 54, 55, 61, 69, 75, 98
Top finish.....	17, 21
Training / presentation.....	162-163
Transfer foils.....	99
Travel kit.....	372
Triple-action cleaner for nails.....	87
Tweezers.....	239, 240

UVW

UV lamp.....	136
UV&LED base gel.....	19, 23, 36
UV&LED builder gel.....	20, 24, 27, 29
UV&LED coloured gels (Technigel).....	31-37
UV&LED finishing gel.....	21, 26-27
Warm manicure.....	271
Warm manicure kit.....	271
Warm wax.....	258-260
Wipes.....	261, 293, 298

NOTES



Cahier des charges « Ambassadeurs Peggy Sage »

Tous les spécialistes le confirment, dans les études de marché comme dans la presse professionnelle, l'avenir de l'esthétique appartient forcément aux grandes enseignes, aux marques fortes qui possèdent une image nationale et internationale. En choisissant de travailler en partenariat avec Peggy Sage, vous bénéficiez d'une gamme de produits de qualité, disposant d'un capital de notoriété permettant de faciliter leur vente. Pour préserver cette notoriété et faire perdurer cette exigence de qualité, la société Peggy Sage a organisé un réseau de distribution sélective qui met à la charge de ses distributeurs des exigences particulières en terme de qualification et de point de vente. Pour répondre à l'attente particulière des artisans coiffeurs et des esthéticiennes qui se proposent de vendre la marque accessoirement à leur activité professionnelle, Peggy Sage met en place des contrats de partenariat. N'importe quel professionnel n'est donc pas autorisé à vendre la marque Peggy Sage.

Seuls les professionnels respectant les conditions de commercialisation des produits de la marque Peggy Sage peuvent devenir des "Ambassadeurs" Peggy Sage. En passant commande auprès d'un distributeur Peggy Sage, vous vous engagez donc à respecter un certain nombre de conditions:

- Vous devez avoir en permanence le souci de la qualité du service rendu et de la préservation de la bonne notoriété de la marque Peggy Sage.
- Vous devrez procéder aux ventes physiques des produits Peggy Sage exclusivement dans votre institut ou votre salon de coiffure.
- Vous ne devez revendre les produits de la gamme "Professionnel" qu'à d'autres ambassadeurs Peggy Sage ou distributeurs agréés, à l'exclusion de toute revente à des consommateurs.
- Les produits Peggy Sage doivent être commercialisés dans un environnement et une organisation qui correspondent à leur image pour ne pas être dévalorisés par les clients.
- Votre lieu de travail doit être doté d'un aménagement, d'une décoration et d'un éclairage permettant d'assurer un stockage et une présentation irréprochable des produits en participant à leur mise en valeur technique et esthétique.
- Vous devrez organiser l'accueil de la clientèle selon les règles de l'art propres à votre profession de coiffeur ou d'esthéticien.
- Vous devrez accepter au moment de l'ouverture du compte et à tout moment par la suite, tout contrôle de votre point de vente par Peggy Sage ou par un mandataire désigné par lui.
- Vous bénéficiez de la notoriété de la marque dans le cadre de la revente des produits revêtus de la marque Peggy Sage et à l'exclusion de tout autre objet ou application.
- Vous devrez informer la société Peggy Sage sans délai de tout acte d'imitation de contrefaçon ou de concurrence déloyale et plus généralement de tout fait ou acte susceptible de porter atteinte aux droits de propriété intellectuelle sur la marque Peggy Sage.
- Vous vous engagez à respecter les dispositions relatives à l'obligation de communication précontractuelle prévues aux articles L 111 -1 et R 111-1 du code de la consommation en cas de vente de la gamme "Exclusif" à un consommateur final. Peggy Sage se dégage de toute responsabilité en cas de manquement à l'obligation précontractuelle susmentionnée.

EN CONTREPARTIE :

- Peggy Sage et votre distributeur habituel s'engagent à ne vendre que des produits de qualité irréprochable.
- Vous conserverez votre indépendance sans avoir de redevance à payer, sans vous soucier de gestion d'image.
- Vous recevrez diverses publications sur les produits Peggy Sage.
- Vous bénéficierez des campagnes de communication nationale et internationale pour les produits Peggy Sage notamment dans la presse professionnelle afin de maintenir voire de développer la notoriété de la marque sur laquelle s'appuie la distribution de ses produits.
- Peggy Sage vous informera régulièrement par son réseau de délégués commerciaux des caractéristiques scientifiques, techniques et commerciales des nouveaux produits et s'engage, à ce titre, à fournir des fiches techniques sur tous les nouveaux produits.
- Peggy Sage s'engage à fournir une assistance en matière de communication en fonction des besoins évalués par la société Peggy Sage et des disponibilités.
- Peggy Sage vous fournira l'assistance technique pour sa présentation et celle des produits dans la mesure de ses besoins et des disponibilités de la société Peggy Sage.

Communication : Célia Gaidatzis, Florian Porzyc.

Conception, création / Designed and created by: Aurélie Gabrion, Célia Gaidatzis, Jean-Marc Lehodey, Moris Merle, Justine Perez, Florian Porzyc.

Rédaction / writing : Célia Gaidatzis, Déborah Piga, Florian Porzyc.

Réalisation / Realization : Aurélie Gabrion, Jean-Marc Lehodey, Moris Merle, Justine Perez.

Photo : Faustine Damm, Aurélie Gabrion, Jean-Marc Lehodey, Studio Davolo, Studio Sémaphore, Yanan Wang.

Prestations maquillage - coiffure / Make-up, hair styling:

Stéphanie Manganelli, Romain Antonioli

Nail art : Gul Delibas, Anne-Sophie Guillaume

Impression / Printing : Imaye

Remerciements / Thanks to : Dream Team Peggy Sage

'Peggy Sage Ambassadors' requirements specification

All the specialists have confirmed in both market surveys and the trade press that the future of the beauty care industry undoubtedly belongs to the big companies and strong brands that have a national and international image. By choosing to work in partnership with the Peggy Sage Company, you benefit from a range of quality products with an established reputation that is an effective tool for selling them. To preserve this reputation and ensure that this demand for quality continues, the Peggy Sage Company has organized a selective distribution network that requires its distributors to fulfil specific requirements regarding qualification and their sales outlet. To meet the particular needs of small hairdressing and beauty salon businesses that propose to sell the brand in addition to their professional activity, Peggy Sage arranges partnership contracts. So not just any professional is authorized to sell the Peggy Sage brand.

Only those professionals that comply with the marketing conditions of products of the Peggy Sage brand can become Peggy Sage 'Ambassadors'.

When placing an order with a Peggy Sage distributor you therefore undertake to comply with a number of conditions:

- You must always strive to provide quality customer service and to maintain the good name of the Peggy Sage brand;
- You must conduct the physical sale of 'Peggy Sage' products only in your beauty or hairdressing salon;
- You may resell products in the 'Professional' range only to other Peggy Sage Ambassadors or approved distributors and under no circumstances to consumers;
- The environment and organization of your marketing of Peggy Sage products must be in line with their image to ensure that they are not undervalued by your customers;
- Your workplace must be laid out, decorated and lit in such a way as to guarantee that the products are stored and presented in an impeccable manner, while ensuring that the environment helps to enhance their technical and aesthetic image;
- You must ensure that your customer service is in line with the rules dictated by your profession of hairdresser or beautician;
- You must permit, from the moment your account is opened and at any point thereafter, all inspections of your sales outlet by Peggy Sage or an appointed agent;
- You shall benefit from the brand's reputation within the scope of the retail of products bearing the Peggy Sage brand and to the exclusion of all other objects and applications.
- You must inform the Peggy Sage Company without delay of any instance of imitation, counterfeiting or unfair competition and more generally of any occurrence or act that may be detrimental to the intellectual property rights to the 'Peggy Sage' brand;
- You undertake to comply with the provisions regarding the supply of information prior to the conclusion of the agreement stipulated in Articles L 111-1 and R 111-1 of the French Consumer Code in the case of the sale of the 'Exclusive' range to an end consumer. Peggy Sage shall not be liable in the event of failure to fulfil the above-mentioned pre-contractual obligation.

IN RETURN:

- Peggy Sage and your usual distributor undertake to sell only products of faultless quality.
- You shall retain your independence and will not be required to pay a fee or be involved in image management;
- You shall be sent various publications featuring Peggy Sage products;
- You shall benefit from national and international communication campaigns for Peggy Sage products particularly in the trade press in order to maintain or increase the brand's reputation on which the distribution of its products is dependent.
- Peggy Sage shall regularly inform you through its network of sales agents of the scientific, technical and sales characteristics of new products and undertakes to provide technical descriptions of all new products to this end.
- Peggy Sage undertakes to provide assistance with communication, depending on the requirements identified by the Peggy Sage Company and subject to availability.
- Peggy Sage shall provide you with technical assistance regarding its presentation and that of its products, depending on the requirements and subject to the availability of the Peggy Sage Company.

Les photos et illustrations présentes dans ce catalogue sont la propriété exclusive de Peggy Sage et/ou de leurs auteurs. La reproduction de ces visuels a été autorisée par les auteurs et les mannequins au profit exclusif de Peggy Sage et pour les besoins de la communication qu'elle met en place dans son réseau de distribution. Toute reproduction, qu'elle soit partielle ou totale, est donc interdite. Le non-respect de cette interdiction entraînera des sanctions. Droits de reproduction, d'adaptation, de traduction, d'interprétation, même partielles, réservés pour la France et l'étranger. Photos non contractuelles. Les nuances reproduites le sont aussi fidèlement que le permettent les techniques d'impression. La plupart de nos produits sont à usage professionnel et nécessitent des compétences techniques, sans garantie en cas de vente au public. Dans la limite des stocks disponibles.

The photographs and illustrations in this catalogue are the exclusive property of Peggy Sage and/or their authors. Reproduction of the artwork has been authorised by the authors and models exclusively for use by Peggy Sage and for the purposes of publicity used within its distribution network. Any reproduction of all or part of the artwork is therefore prohibited. Failure to comply with this prohibition will result in legal proceedings. Reproduction, adaptation, translation and interpretation rights for all or part of this document are reserved for France and abroad. Photographs are non contractual. The colours in the catalogue are reproduced as faithfully as the printing technology used allows. Most of our products are for professional use and require technical skills; they are not guaranteed if sold to the public. Subject to stock availability.

